

# **USER MANUAL**

## **METER FOR ELECTRICAL INSTALLATION PARAMETERS**

**MPI-535**

# MPI-535

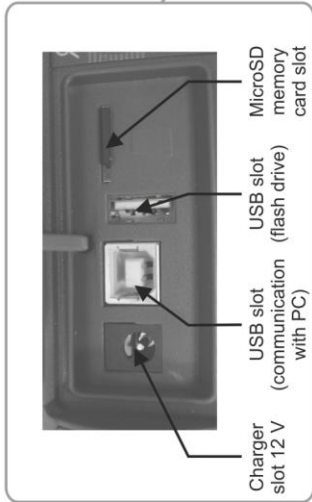

Clamps slots  $R_E$  - measurement of earth systems

Measuring terminals

ES socket for measuring earth resistance and soil resistivity



Starting the measurement procedure

Contact electrode

Touchscreen

Turning the meter on/off

Straps loops

- Back
- Save
- Show last measurement
- Return to main menu
- Select item
- Show more icons
- Add item
- Edit item
- Search
- Remove item
- Close menu



## **USER MANUAL**

# **METER FOR ELECTRICAL INSTALLATION PARAMETERS MPI-535**



**SONEL S.A.  
Wokulskiego 11  
58-100 Świdnica  
Poland**

Version 1.13 10.04.2026

MPI-535 meter is a modern, easy in use and safe measuring device. Please acquaint your-self with this manual in order to avoid measuring errors and prevent possible problems in operation of the meter.

# CONTENTS

<b>1</b>	<b>Safety</b>	<b>6</b>
<b>2</b>	<b>Main menu</b>	<b>7</b>
2.1	Meter settings	8
2.1.1	Setting date and time	9
2.1.2	Automatic shutdown	10
2.1.3	Display parameters	11
2.2	Settings of measurements	12
2.2.1	Sub-menu Measurement Settings	12
2.2.2	Sub-menu Edit fuses	14
a.	Adding fuse characteristics	14
b.	Adding fuses	19
2.3	Communication	21
2.3.1	USB communication	21
2.3.2	Connection to a Wi-Fi network	21
2.3.3	E-mail settings	21
2.4	Update	22
2.4.1	Update via USB	22
2.4.2	Update via Wi-Fi	22
2.5	Regional settings	23
2.6	Meter information	24
<b>3</b>	<b>Measurements</b>	<b>25</b>
3.1	Diagnostics performed by the meter – limits	26
3.2	Measurement of alternating voltage and frequency	26
3.3	Checking the correctness of PE (protective earth) connections	27
3.4	Fault loop parameters	28
3.4.1	Settings of measurements	28
3.4.2	Fault loop parameters in the L-N and L-L circuits	30
3.4.3	Fault loop parameters in the L-PE circuit	33
3.4.4	Fault loop impedance in L-PE circuit protected with a residual current device (RCD)	36
3.4.5	Prospective short-circuit current	39
3.4.6	Measurement of fault loop impedance in IT networks	40
3.5	Voltage drop	41
3.6	Resistance-to-earth	43
3.6.1	Settings of measurements	43
3.6.2	Earth resistance measurement with 3-pole method ( $R_{E3P}$ )	44
3.6.3	Earth resistance measurement with 4-wire method ( $R_{E4P}$ )	48
3.6.4	Earth resistance measurement with 3-pole method with additional clamp ( $R_{E3P+C}$ )	52
3.6.5	Earth resistance measurement with two-clamp method (2C)	56
3.7	Soil resistivity	59
3.7.1	Settings of measurements	59
3.7.2	Main elements of the screen	60
3.7.3	Soil resistivity measurements ( $\rho$ )	61
3.8	RCD parameters	65
3.8.1	Settings of measurements	65
3.8.2	RCD tripping current	68
3.8.3	RCD tripping time	71
3.8.4	Measurements in IT networks	74
3.9	Automatic measurements of RCD parameters	75
3.9.1	Setting automatic measurements of RCD parameters	75
3.9.2	Automatic measurement of RCDs	76

3.10	Insulation resistance .....	81
3.10.1	Settings of measurements .....	81
3.10.2	Measurement using probes.....	85
3.10.3	Measurements using UNI-Schuko adapter (WS-03 and WS-04) .....	87
3.10.4	Measurements using AutoISO-1000c.....	90
3.11	Low-voltage resistance measurement.....	94
3.11.1	Resistance measurement .....	94
3.11.2	Measurement of resistance of protective conductors and equipotential bonding with $\pm 200$ mA current .....	97
3.12	Phase sequence .....	101
3.13	Motor rotation direction.....	102
3.14	Illuminance.....	104
<b>4</b>	<b>Auto measurements .....</b>	<b>106</b>
4.1	Proceeding auto measurements .....	106
4.2	Creating measurement procedures.....	108
<b>5</b>	<b>Memory of the meter .....</b>	<b>110</b>
5.1	Memory settings.....	110
5.2	Structure of the Memory.....	111
5.2.1	Fundamentals of navigating the Memory menu.....	112
5.2.2	Adding a new measurements tree.....	114
5.3	Entering the measurement result .....	119
5.4	Viewing saved measurements .....	120
5.5	Sharing recorded measurements .....	122
5.6	Searching the meter memory .....	123
<b>6</b>	<b>Power supply.....</b>	<b>124</b>
6.1	Monitoring of the battery charge status .....	124
6.2	Replacing rechargeable batteries.....	124
6.3	Charging the rechargeable batteries.....	125
6.4	General rules for using Li-Ion rechargeable batteries .....	126
<b>7</b>	<b>Cleaning and maintenance .....</b>	<b>127</b>
<b>8</b>	<b>Storage.....</b>	<b>127</b>
<b>9</b>	<b>Dismantling and utilisation.....</b>	<b>127</b>
<b>10</b>	<b>Technical data .....</b>	<b>128</b>
10.1	Basic data .....	128
10.1.1	Measurement of alternating voltages (True RMS) .....	128
10.1.2	Frequency measurement .....	128
10.1.3	Measurement of fault loop impedance $Z_{L-PE}$ , $Z_{L-N}$ , $Z_{L-L}$ .....	128
10.1.4	Measurement of fault loop impedance $Z_{L-PE(RCD)}$ (without triggering of RCD) .....	129
10.1.5	Measurement of parameters of RCD.....	130
10.1.6	Measurement of resistance-to-earth $R_E$ .....	133
10.1.7	Low-voltage measurement of continuity of circuit and resistance .....	134
10.1.8	Measurement of insulation resistance .....	135
10.1.9	Light measurements .....	136
10.1.10	Phase sequence.....	137
10.1.11	Motor rotation.....	137
10.2	Other technical data .....	138
10.3	Bluetooth specification .....	138

10.4 Additional data .....	139
10.4.1 Additional uncertainties according to IEC 61557-2 ( $R_{ISO}$ ) .....	139
10.4.2 Additional uncertainties according to IEC 61557-3 (Z).....	139
10.4.3 Additional uncertainties according to IEC 61557-4 ( $R \pm 200 \text{ mA}$ ) .....	139
10.4.4 Additional uncertainties of earth resistance measurement ( $R_E$ ) .....	139
10.4.5 Additional uncertainties according to IEC 61557-6 (RCD) .....	140
10.5 List of reference standards.....	141
<b>11 Accessories.....</b>	<b>142</b>
<b>12 Positions of the meter's cover .....</b>	<b>142</b>
<b>13 Manufacturer .....</b>	<b>143</b>

# 1 Safety

MPI-535 meter is designed for performing check tests of protection against electric shock in AC mains systems and recording the parameters of electric mains. The meter is used for making measurements and providing results to determine safety of electrical installations. Therefore, in order to provide conditions for correct operation and accuracy of obtained results, the following recommendations must be observed:

- Before you proceed to operate the meter, acquaint yourself thoroughly with the present manual and observe the safety regulations and specifications provided by the producer.
- Any application that differs from those specified in the present manual may result in a damage to the device and constitute a source of danger for the user.
- MPI-535 meters must be operated only by appropriately qualified personnel with relevant certificates authorising the personnel to perform works on electric systems. Operating the meter by unauthorised personnel may result in damage to the device and constitute a source of danger for the user.
- Using this manual does not exclude the need to comply with occupational health and safety regulations and with other relevant fire regulations required during the performance of a particular type of work. Before starting the work with the device in special environments, e.g. potentially fire-risk/explosive environment, it is necessary to consult it with the person responsible for health and safety.
- It is unacceptable to operate:
  - ⇒ a damaged meter which is completely or partially out of order,
  - ⇒ a meter with damaged insulation,
  - ⇒ a meter stored for an excessive period of time in disadvantageous conditions (e.g. excessive humidity). If the meter has been transferred from a cool to a warm environment with a high level of relative humidity, do not start measurements until the meter is warmed up to the ambient temperature (approximately 30 minutes).
- If the battery is discharged to a level preventing further measurements, the meter displays an appropriate message and then turns off.
- Battery spill and damage to the meter may occur if discharged batteries are left in the meter.
- Before measurements may commence, make sure the leads are connected to the appropriate measurement sockets.
- Do not operate a meter with an open or incorrectly closed battery (accumulator) compartment or power it from other sources than those specified in the present manual.
- **R<sub>iso</sub>** meter inputs are electronically protected against overloads (caused by e.g. connecting the meter to a live circuit) up to 463 V RMS for 60 seconds.
- Repairs may be performed only by an authorised service point.



## NOTE!

Only accessories for a given device should be used. Using other accessories may cause damage to measuring terminals, introduce additional measurement error and create a risk for the user.



Due to continuous development of the meter's software, the actual appearance of the display, in case of some of the functions, may slightly differ from the display presented in this operating manual.

## 2 Main menu

The main screen is available:

- after the meter has been turned on,
- at any time after the  icon has been selected on the display (does not apply to the recorder).

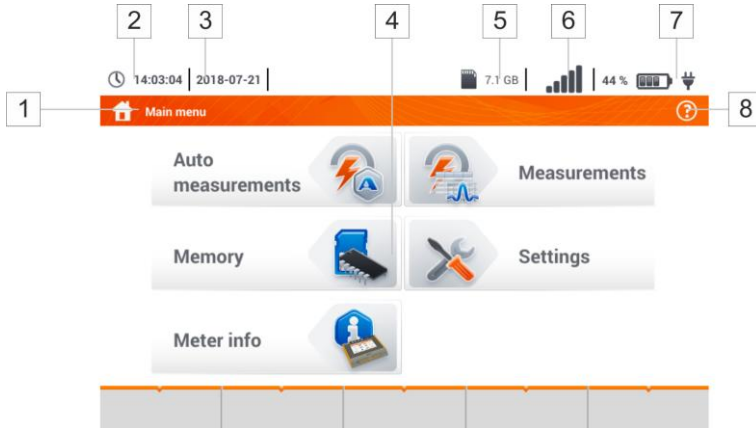

Fig. 2.1 Main elements of the screen

### 1 Name of the active menu

The fact of introducing a change that has not been saved yet is indicated by the \* symbol in the screen header.



### 2 Time

### 3 Date

### 4 Main screen

### 5 Free space on the memory card

If the card is not in the slot, the icon on the screen is crossed out.

### 6 Wireless network signal strength

### 7 Battery discharge indicator

### 8 Active menu help

- Visualisation of connection systems
- Explanation of icons

Touching a selected main menu item redirects to the sub-menu. Available options:

- **Settings** – going to the settings of the main functions and parameters of the meter,
- **Measurements** – Selecting the measurement function. The description of individual functions is provided in **section 3**,

- **Memory** – viewing and managing the saved measurement results. A detailed description of the function is provided in **section 5**,
- Meter information

## 2.1 Meter settings

The **date**, **time** and display **brightness** can be set from the **Meter settings** screen level.

①  In the main menu select **Settings**.

②  Select **Meter settings**

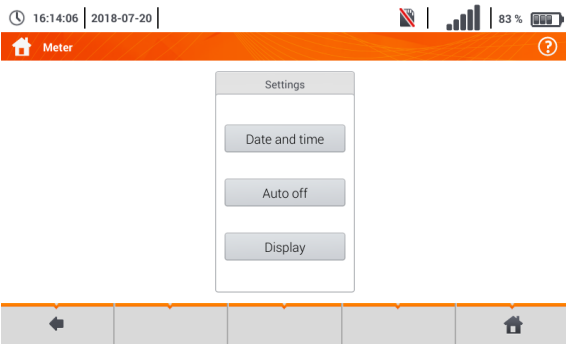
③  Parameters to change  
 ⇒ Date and time (**section 2.1.1**)  
 ⇒ Auto off (**section 2.1.2**)  
 ⇒ Display (**section 2.1.3**)

## 2.1.1 Setting date and time

1

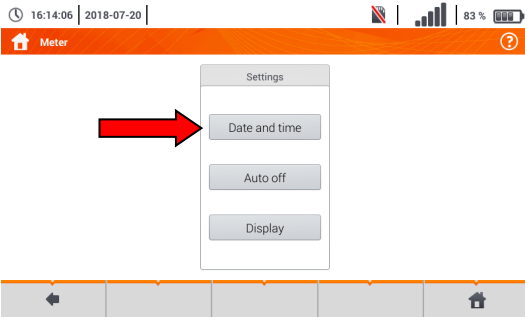

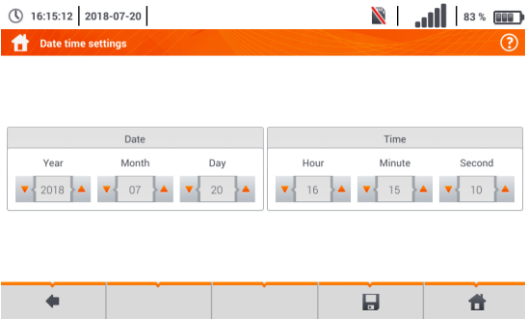

Select **Date and time**.

2



Touch the appropriate icon to modify the selected parameter:

 value increase by 1,

 value decrease by 1,

 touching opens the field for manual entering of the value (step 3).

3

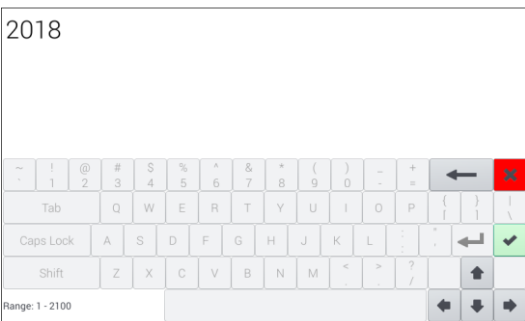

Delete the existing entry and enter the required value manually.

### Functions of icons

 reject the changes and return to step 2

 accept changes and go to step 4

4

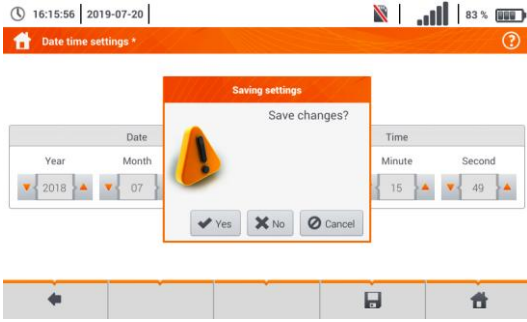

Description of function icons

- ← return to the previous screen  
After touching the icon you may be prompted to save or reject changes (figure):  
**Yes** – accept selection,  
**No** – reject changes,  
**Cancel** – cancel the action
- saving changes
- return to the main menu

### 2.1.2 Automatic shutdown

1

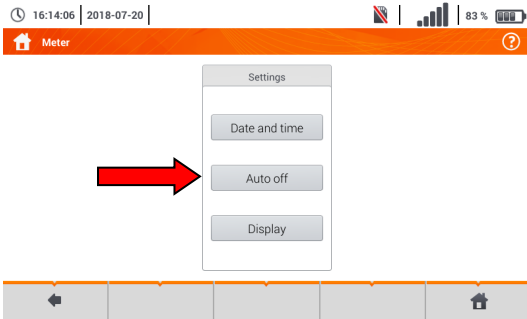

Select **Auto off**.

2

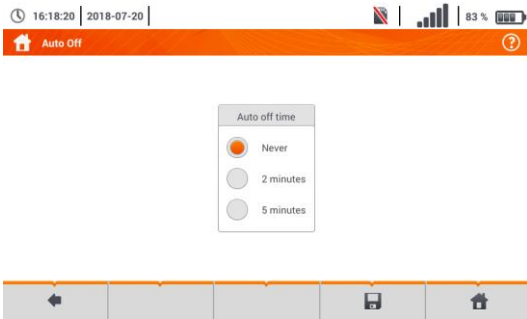

Select the required option.

3

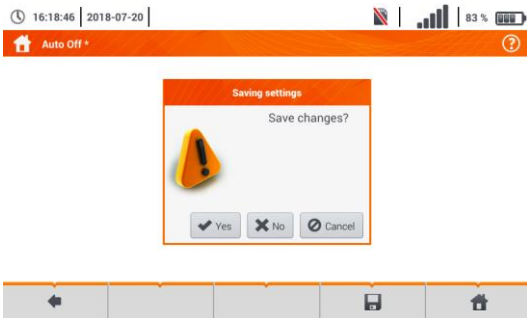

Description of function icons

- ← return to the previous screen  
After touching the icon you may be prompted to save or reject changes (figure):  
**Yes** – accept selection,  
**No** – reject changes,  
**Cancel** – cancel the action
- saving changes
- return to the main menu

## 2.1.3 Display parameters

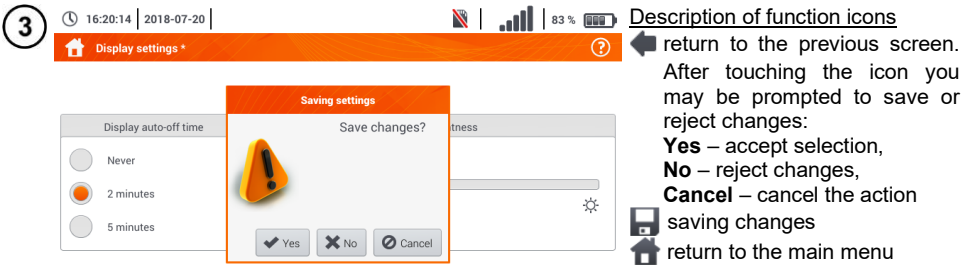
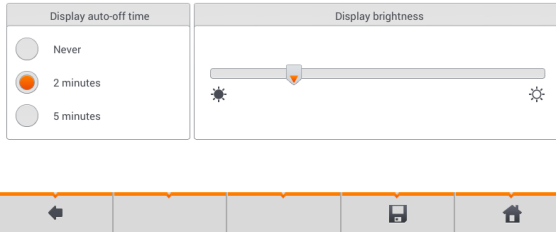
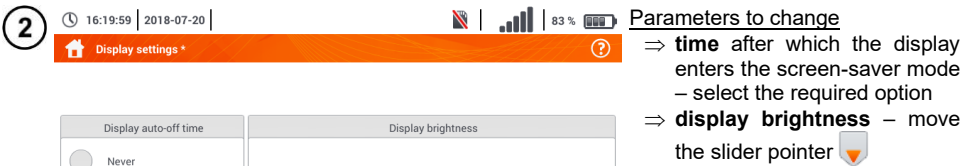
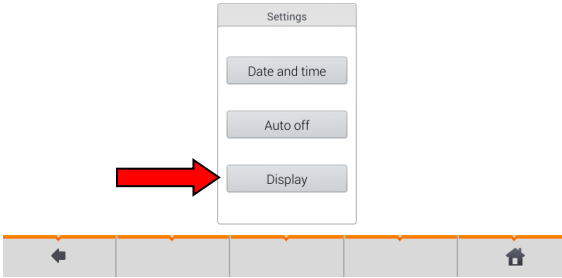

## 2.2 Settings of measurements

From the **Measurement settings** menu it is possible to edit:

- network parameters,
- fuse definitions.

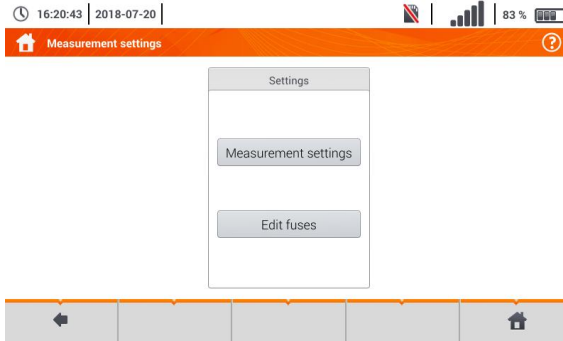

### 2.2.1 Sub-menu Measurement Settings

The option of **Measurement settings** consists of:

- mains rated voltage,
- network frequency,
- manner of presentation of short-circuit loop result,
- type of mains for the tested object,
- system of units,
- memory settings (auto-incrementing memory cells),
- auto measurements timer,
- RCD EV measurement standard.

Before the measurements select the **type of mains** from which the tested object is powered. Then select the **mains rated voltage**  $U_n$  (110/190 V, 115/200 V, 127/220 V, 220/380 V, 230/400 V or 240/415 V). This voltage value is used for calculating the values of prospective short-circuit current.

Determination of **network frequency** that is the source of potential interferences is necessary in order to select a proper measuring signal frequency in resistance-to-earth measurements. This selection ensures optimum interference filtering. The meter is designed for filtration of interferences generated by 50 Hz and 60 Hz networks.

**RCD EV measurement standard** defines the parameters for measuring RCD protectors dedicated to the field of electromobility and photovoltaics.

Setting **Autoincrementing** as active ( → ) causes each saved measurement (**section 5.3**) to be placed in an automatically created new measurement point (**section 5.2.2** step (14)).

**Auto measurements timer** determines the time interval of starting subsequent steps of the measurement procedure.

1



- Expand the selection list using the  icon.
- Select the required parameter value.



Selection and modification options

- $U_n$  voltage
  - ⇒ 110/190 V
  - ⇒ 115/200 V
  - ⇒ 127/220 V
  - ⇒ 220/380 V
  - ⇒ 230/400 V
  - ⇒ 240/415 V
- Frequency  $f_n$ 
  - ⇒ 50 Hz
  - ⇒ 60 Hz
- Fault loop measurement form
  - ⇒  $I_k$  – prospective short-circuit current
  - ⇒  $Z_s$  – fault loop impedance
- System type
  - ⇒ TN/TT
  - ⇒ IT
- System units, of
  - ⇒ metric
  - ⇒ imperial
- Autoincrementing
  - ⇒  enabled
  - ⇒  disabled
- Auto measurements timer
  - ⇒ Turn off
  - ⇒ 0...5 s

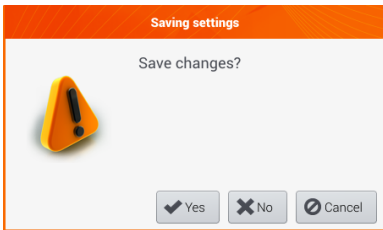
2



Description of function icons

-  return to the previous screen. After touching the icon you may be prompted to save or reject changes:
  - Yes** – accept selection,
  - No** – reject changes,
  - Cancel** – cancel the action
-  saving changes
-  returning to the main menu

## 2.2.2 Sub-menu Edit fuses

On the **Fuse base** screen the following parameters of circuit breakers can be defined and edited:

- manufacturer,
- model (type) of fuse,
- characteristic of fuse.

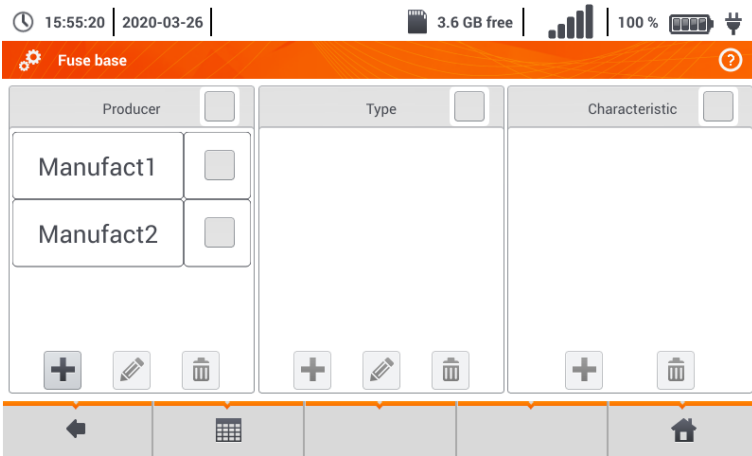

### a. Adding fuse characteristics

1

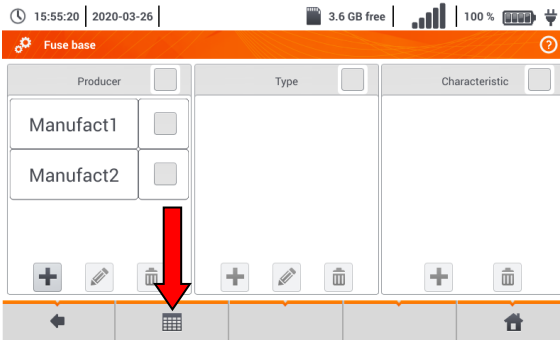

• Select the  icon.

• A menu will appear for adding time-current characteristics of fuses.

2

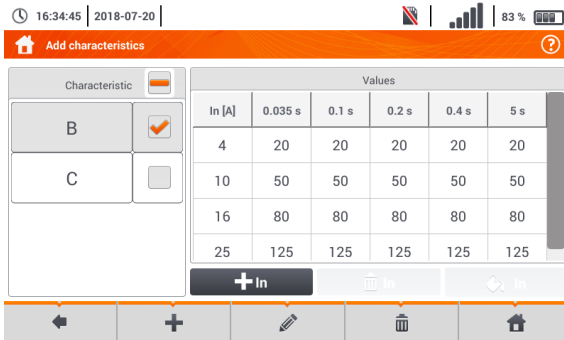

### Available options

- adding characteristics for the selected fuse rated current.
- removing characteristics for the selected fuse rated current.
- pasting the set value for records in the whole row or table.

### Description of function icons

- inactive characteristic
- active characteristic
- adding a new characteristic
- editing the name of the active characteristic
- removing the active characteristic
- returning to the previous screen
- going to the main menu

3

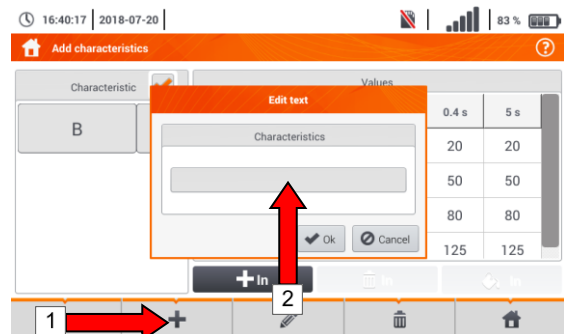

To create a new characteristic:

- select the **+** icon,
- touch the name selection field.

4

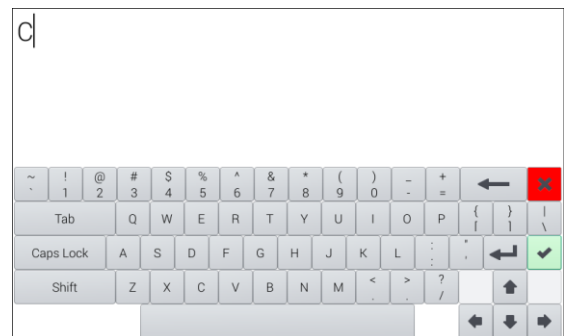

Enter the name from the touch keypad (holding certain buttons for a longer time triggers Polish characters).



### Functions of icons

- rejecting changes and returning to step 3
- accepting changes and going to step 5

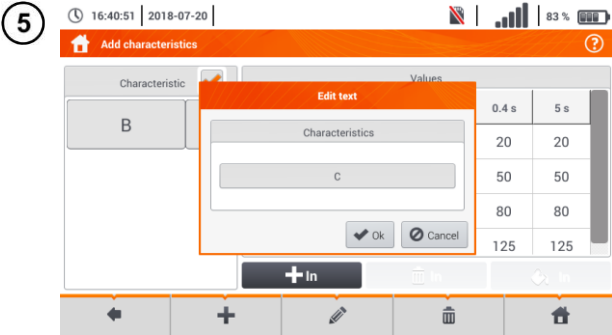

Description of function icons

- Ok** – accept the name
- Cancel** – cancel the action

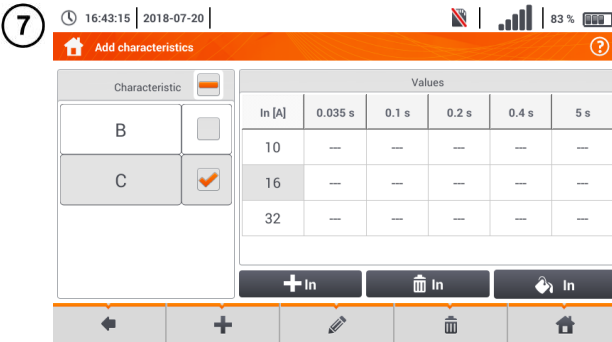

- Activate the created characteristic .
- Add rated fuse current using icon .
- Editing fuse data proceed as in steps **3** **4** **5**.



- To activate a row of data, select any item in the row.
- Icons   will be activated.

8

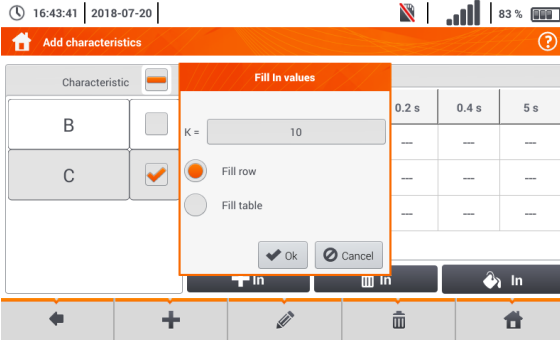

After selecting , the following options are available:

- ⇒ **parameter K** – setting the multiplication factor of fuse rated current (parameter of the time-current characteristic),
- ⇒ **fill row** – copying K value to the selected row,
- ⇒ **fill table** – copying K value to all records.

- Touch the K parameter edit field.
- Enter the parameter values as in step 4.

Description of function icons

**Ok** – accept selection

**Cancel** – cancel changes

9

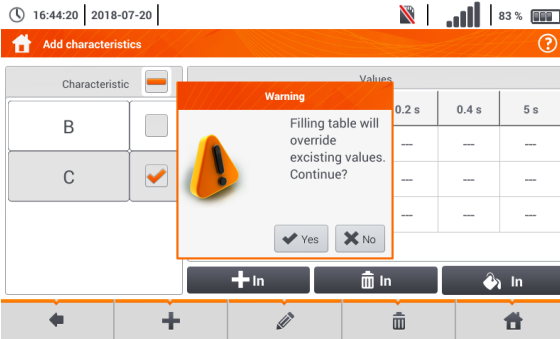

You will be prompted to conform the selection.

Description of function icons

**Yes** – accept selection

**No** – reject changes

10

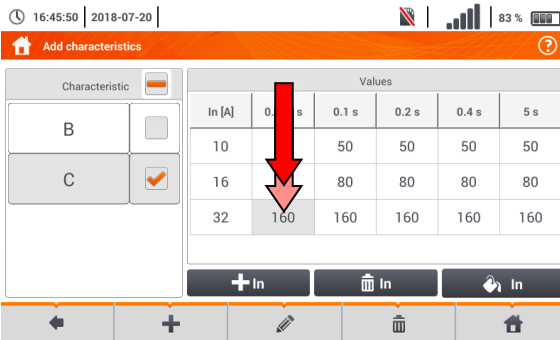

To change the contents of a selected cell, touch it **twice**.

11

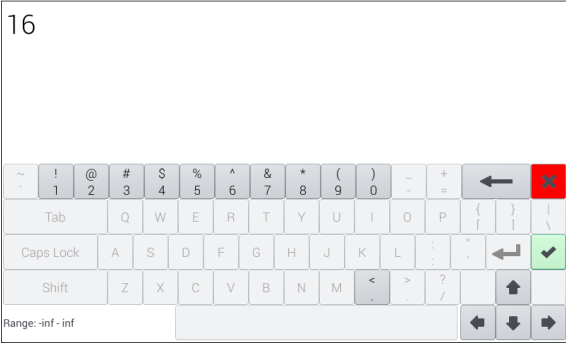



On-screen keyboard will appear. Delete the existing entry and enter the required one.

Functions of icons

- ✖ reject changes and return to the menu for adding characteristics
- ✔ accept changes and return to the menu for adding characteristics

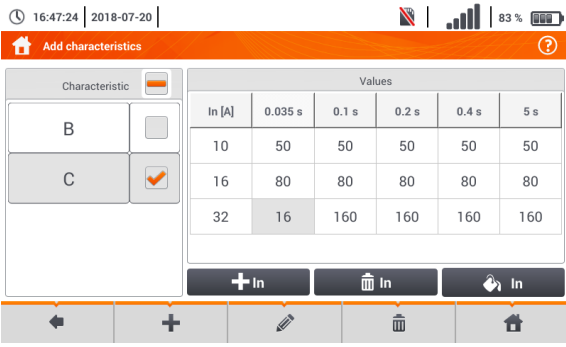
12



Select the  icon and return to the fuse base menu.

## b. Adding fuses

1

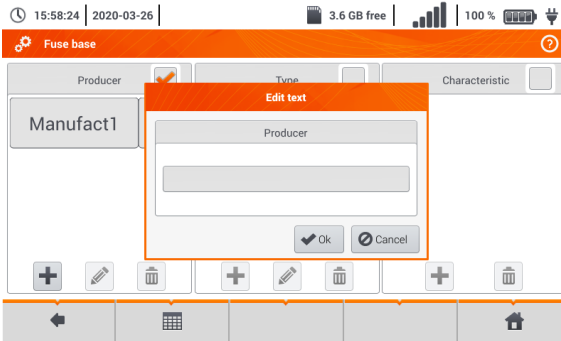

Add a producer.

- In **Producer** column press **+**.
- Touch the name input field.
- Enter the name from the touch keypad (holding certain buttons for a longer time triggers additional characters).

Functions of icons

- ✖ reject the changes
- ✔ accept changes and go to step

2

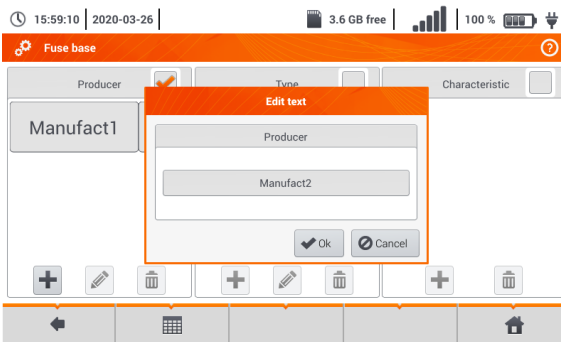

2

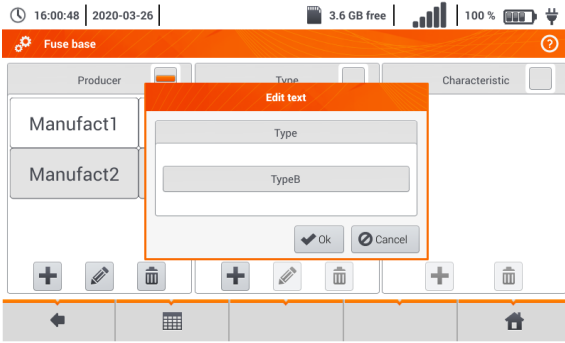

- Select the producer.
- In **Type** column press **+**.
- Enter the fuse model as in step 1.

3

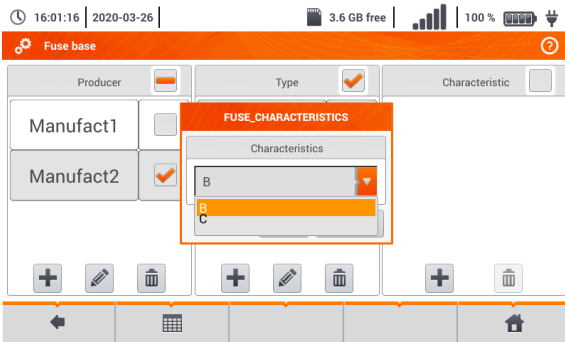

- Highlight the required type of fuse.
- In the **Characteristic** column press **+**.
- Enter the fuse characteristic from list.

4

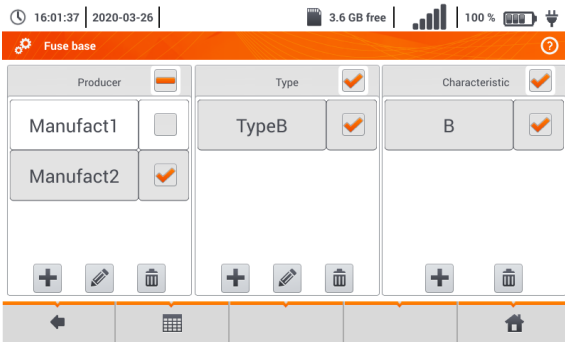

Description of function icons

- record inactive
- record active
- +** add new record
- edit active record name
- remove active record
- return to the previous screen
- return to the main menu

## 2.3 Communication

### 2.3.1 USB communication

The B-type USB port built-in in the meter is used to connect the meter to the computer in order to download the data stored in its memory. The data may be downloaded and read through the software provided by the manufacturer.

- **Sonel Reader** – the software is used to retrieve the data saved from the meter memory. In addition, it enables data transfer to the PC, data saving in popular formats and printing.
- **Sonel Reports PLUS** – supports creation of documentation after testing of electrical installation. Software communicates with Sonel test instruments, download data from memory of test instrument and creates necessary documentation.

Detailed information is available from the manufacturer and distributors.

- 1 Connect the cable to the USB port of the computer and the USB slot of the meter.
- 2 Start the program.



Current versions of software may be found at the manufacturer's website in section **Download**.

### 2.3.2 Connection to a Wi-Fi network

- 1 Go to **Settings** ► **Communication settings** ► **Wi-Fi**.
- 2 Turn on Wi-Fi (the Wi-Fi status icon  should appear in the top bar).
- 3 Select a network with Internet access from the list. Touch it twice and - if it is password-protected - enter the password. To log out of the network, also tap it twice.
- 4 Select **Ok** and check that the meter is connected to the network. The Wi-Fi status icon will then indicate the signal strength.

### 2.3.3 E-mail settings

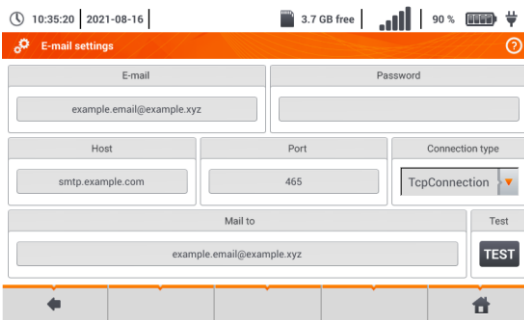

- Go to **Settings** ► **Communication settings** ► **E-mail settings**.

- Fill the fields on the screen:
  - o parameters of the outbox,
  - o target mailbox address.

- Press **TEST** to send a test email.



The function works with selected email providers. The list of suppliers is available on the manufacturer's website.

## 2.4 Update



### NOTE!

- Before you proceed to software update, charge the accumulators.
- Do not switch off the meter while updating.

### 2.4.1 Update via USB

- 1 The update file can be downloaded from the manufacturer's website.
- 2 Save the file to a USB drive. The memory must have the FAT32 file system.
- 3 Select **Settings ► Update** to open the update menu.

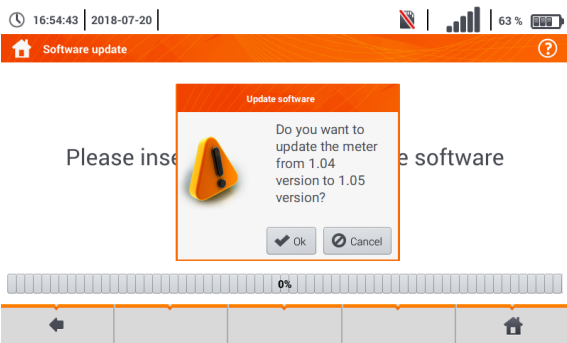
4 

- Insert the USB memory in the Type A USB port in the meter. The information screen will appear.
- To start the update process, select **Ok** in the information window.



Alternatively, you can press the **Update via Wi-Fi** button. Then follow the procedure described in **sec. 2.4.2**.

### 2.4.2 Update via Wi-Fi

- 1 Connect to the Wi-Fi network according to **sec. 2.3.2**.
- 2 Choose one of the following.
  - Go to **Settings ► Software update** and select **Update via Wi-Fi**.
  - Restart the meter.
- 3 The device will automatically check if a software update is available. If it is, a window is displayed asking the user to accept the update.
- 4 To start the update process, select **Ok** in the information window.



Security features inside some networks may prevent the meter from being able to connect to the manufacturer's server with updates – then the following message will be displayed: **Unable to update Wi-Fi...**

## 2.5 Regional settings

1

09:48:49 | 2018-07-21



Regional settings

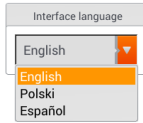

- Select **Settings** ► **Regional** to open the language settings menu.
- Expand the list of languages to select from.
- Select the required language.

### Description of function icons

← return to the previous screen (you may be prompted to save or reject changes)

💾 saving changes

🏠 returning to the main menu

2

09:49:14 | 2018-07-21



Regional settings \*

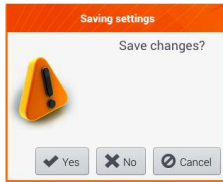

If the changes have not been saved or the ← icon was selected, a prompt will appear to confirm the selection.

### Description of function icons

**Yes** – accept selection

**No** – reject selection

**Cancel** – cancel the action

## 2.6 Meter information

1 14:03:04 | 2018-07-21 | 7.1 GB | 44% | Select **Meter info** in the main menu.

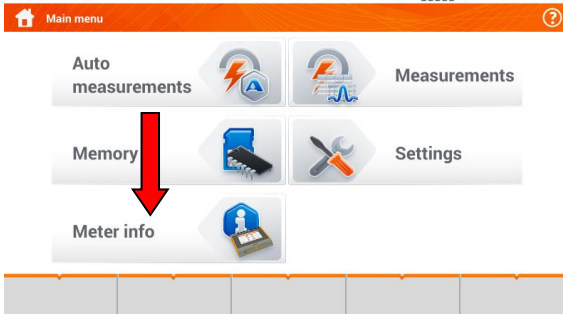

2 15:10:30 | 2019-01-24 | 47% | The menu contains information on the manufacturer and the meter.

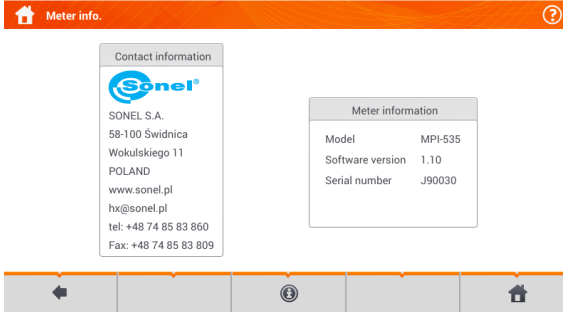

### Description of function icons

← return to the previous screen (you may be prompted to save or reject changes)

ⓘ display detailed information

🏠 return to the main menu

3 15:10:42 | 2019-01-24 | 47% | The screen after selecting icon ⓘ.

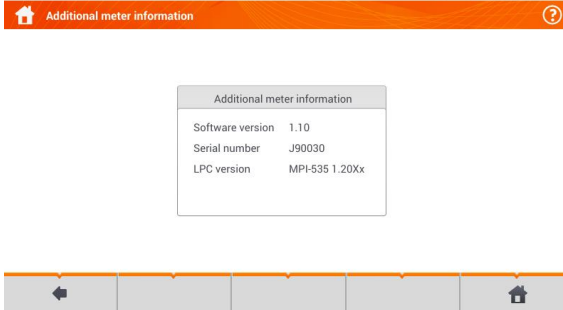

### 3 Measurements



The following tests are available from the **Measurements** menu:

- fault loop impedance ( $Z_{L-N}$ ,  $Z_{L-PE}$ ,  $Z_{L-PE[RCD]}$  with RCD),
- voltage drop  $\Delta U$ ,
- insulation resistance  $R_{ISO}$ ,
- RCD efficiency (operating current  $RCD I_A$ , operate time  $RCD t_A$  and automatic measurements),
- resistance  $R_x$ ,
- continuity of connections  $R_{CONT}$ ,
- phase sequence **1-2-3**,
- direction of motor rotation **U-V-W**,
- resistance-to-earth  $R_E$ ,
- soil resistivity  $\Omega m$ ,
- illuminance **Lux**.



#### WARNING

**During measurements (fault loop, RCD), do not touch conductive accessible or foreign parts of the tested electrical installation.**



- The content of this chapter should be thoroughly familiarized with. It describes the **meter circuits**, the **methods of measurements** and basic principles concerning **interpretation of measurement results**.
- A progress bar is displayed during long measurements.
- The result of the last measurement is displayed until:
  - next measurement starts,
  - measurement parameters are changed,
  - measurement function is changed,
  - the meter is switched off.
- The last measurement can be recalled using the  icon.



### 3.1 Diagnostics performed by the meter – limits

The meter is able to assess whether the measurement result is within acceptable limits for the selected safety device or the limit value. The user may set a limit, the threshold value which should not be exceeded by the result. It is possible for all measurement functions except for:

- RCD measurements ( $I_A$ ,  $t_A$ ) for which the limits are permanently enabled,
- fault loop measurements, where the limit is determined indirectly by selecting a suitable overcurrent protection for which standard limits are assigned,
- the recorder.

For the measurements of insulation resistance and light the limit is the **minimum** value. For measurements of fault loop impedance, earth resistance, resistance of protective conductors and equipotential bonding - it is the **maximum** value.

The limits are set in the relevant measurement menu. After each measurement the meter displays the symbols:

-  the result is within the set limits,
-  the result is outside the set limits,
-  assessment of the result correctness not possible. The symbol is displayed, when for example the result is not available (e.g. measurement in progress, or no measurement has been performed)

the method for setting limits is described in the sections describing the measurement data.

### 3.2 Measurement of alternating voltage and frequency

The meter measures and displays alternating voltage and network frequency in the selected measurement functions in accordance with the table below.

Measuring function	U	f
$Z_{L-N}$	•	•
$Z_{L-PE}$	•	•
$Z_{L-PE(RCD)}$	•	•
$R_{ISO}$	•	
RCD $I_A$	•	•
RCD $t_A$	•	•
$R_x$		
$R_{CONT}$		
Phase sequence	•	
Motor rotation	•	
Resistance-to-earth $R_E$	•	
Soil resistivity	•	
Illuminance		

### 3.3 Checking the correctness of PE (protective earth) connections

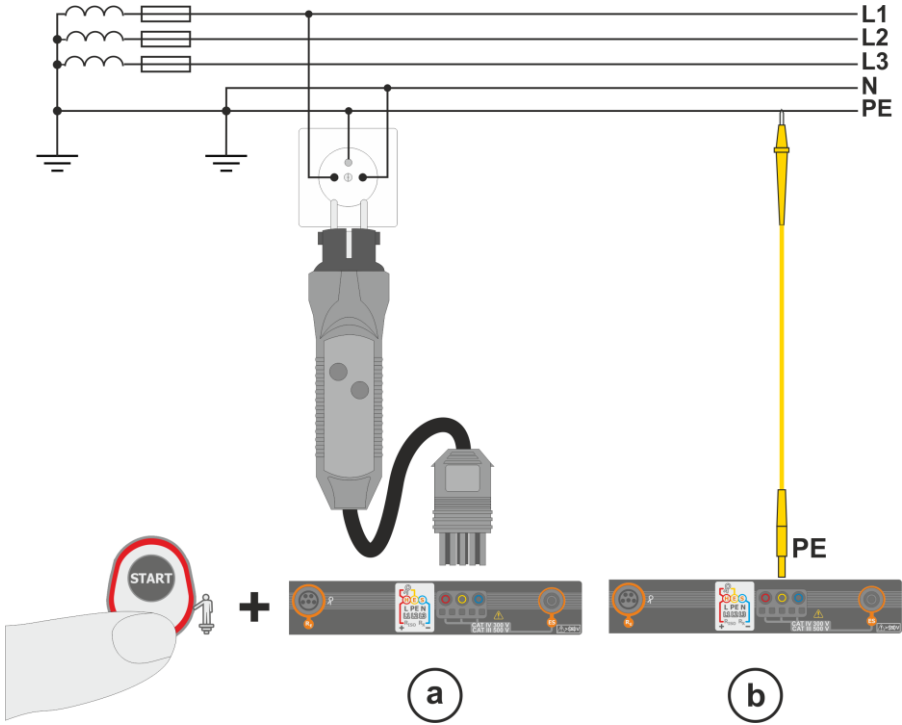

When the meter is connected as in the drawing, touch the contact electrode and wait for about **1 second**. If voltage is detected on the PE conductor, the device:

- will display text **PE!** (installation error, the PE lead connected to the phase conductor) and
- will generate a continuous audio signal

This option is available for all measuring functions that apply to residual current devices (RCD) and fault loop **except  $Z_{L-N}$ ,  $L-L$  measurement**.



#### WARNING

**When phase voltage is detected on PE lead, measurements must be immediately stopped and a fault in the installation must be removed.**



- Make sure to stand on non-insulated ground when measuring. Insulated ground may cause an incorrect test result.
- If the voltage on the PE conductor exceeds the acceptable limit value (approx 50 V), the meter will signal the fact.
- If the IT network has been selected in **section 2.2.1** step **①**, the contact electrode is **inactive**.

### 3.4 Fault loop parameters



#### NOTE!

- If there are residual current devices in the network tested, they should be bypassed by bridging for the period of impedance measurement. However, it should be remembered that the tested circuit is modified in this way and the obtained results may slightly differ from the actual results.
- After completing measurements, always remove modifications introduced to the tested system for the period of measurements and check the operation of the residual current switch.
- The above remarks **do not apply** to measurements of fault loop impedance with the use of function  $Z_{L-PE[RCD]}$ .
- Measurements of short-circuit loop impedance **downstream the inverters** are **ineffective** and measurement results **unreliable**. This is due to the fluctuations of internal impedance of the inverter during its operations. Do not perform measurements of short-circuit loop impedance directly downstream inverters.

#### 3.4.1 Settings of measurements

1  $Z_{L-N, L-L}$   $Z_{L-PE}$   $Z_{L-PE[RCD]}$  Select item  $Z_{L-N, L-L}$ ,  $Z_{L-PE}$  or  $Z_{L-PE[RCD]}$ .

2 10:27:18 | 2018-07-21 | 90%  $Z_{L-N, U_n}$  ?

**L-N!**

$Z = \text{--- } \Omega$

$I_k = \text{--- A}$   
 $I_A = 50,0 \text{ A}$

$U = 0,3 \text{ V}$   
 $f = 0,0 \text{ Hz}$

$L = 1,2 \text{ m}$   
 $N = 1,2 \text{ m}$

$I_k (U_n)$   
 $B10$

↓

• In this case, touch the drop-down list field.

• Select the required lead length.

3 10:28:04 | 2018-07-21 | 90%  $Z_{L-N, U_n}$  ?

**L-N!**

$Z = \text{--- } \Omega$

$I_k = \text{--- A}$   
 $I_A = 0,0 \text{ A}$

$U = 0,2 \text{ V}$   
 $f = 0,0 \text{ Hz}$

$L = 5 \text{ m}$   
 $N = 1,2 \text{ m}$

$I_k (U_n)$   
 $(U_n)$   
 $(U_0)$

↓

The prospective short-circuit current  $I_k$  can be calculated based on one of two values:

- ⇒ rated network voltage  $U_n$ ,
- ⇒ voltage measured by the meter  $U_0$ .

The physical meaning of the parameter is presented in **section 3.4.5**.

- Touch the drop-down list field.
- Select the required value.

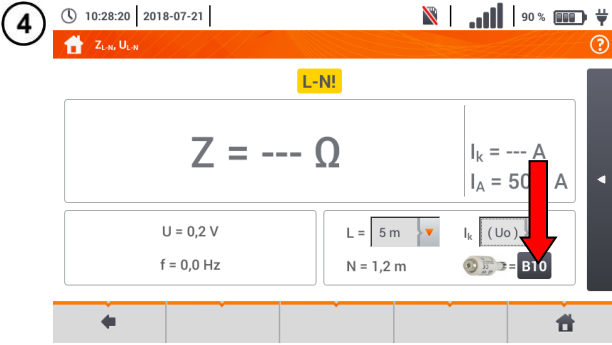

The result can be compared against the acceptable fault loop impedance  $Z_{sdop}$ , determined on the basis of the fuse parameters of the tested circuit:

- ⇒ characteristic,
- ⇒ rated current.

- Touch the fuse type field.

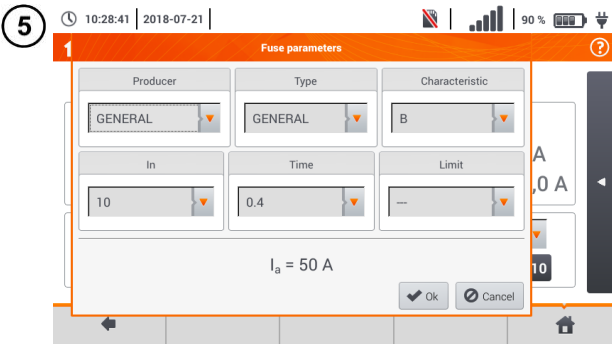

Options to select:

- **Manufacturer**
  - ⇒ GENERAL – no defined manufacturer
  - ⇒ manufacturers defined in the meter memory (**section 2.2.2**)
- **Type**
  - ⇒ GENERAL – no defined type
  - ⇒ types defined in the meter memory (**section 2.2.2**)
- **Time-current characteristic**
- **Rated current  $I_N$**
- **Acceptable response time**
- **Limit** – the limit resulting from standard EN 60364-6
  - ⇒ – –  $I_a$  as in the standard tables – no correction
  - ⇒ **2/3Z** –  $I_a$  is increased by the value of  $0.5I_a$

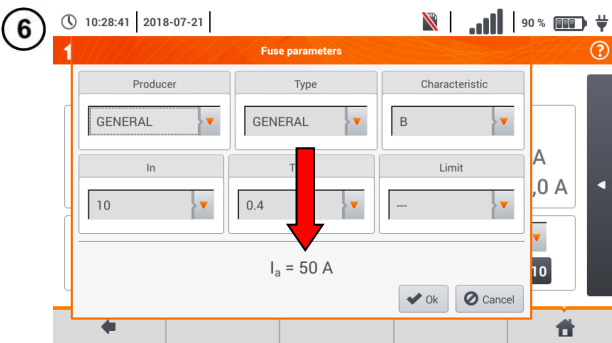

The current is calculated after setting parameters in steps (6) (7).  $I_a$  – current ensuring automatic triggering of a protective device within a required time.

Description of function icons

- Ok** – accept fuse settings
- Cancel** – cancel the action

### 3.4.2 Fault loop parameters in the L-N and L-L circuits

- 1 Connect test leads according to the drawing  
 (a) or (b) for measurement in the L-N circuit,  
 (c) for measurement in the L-L circuit.

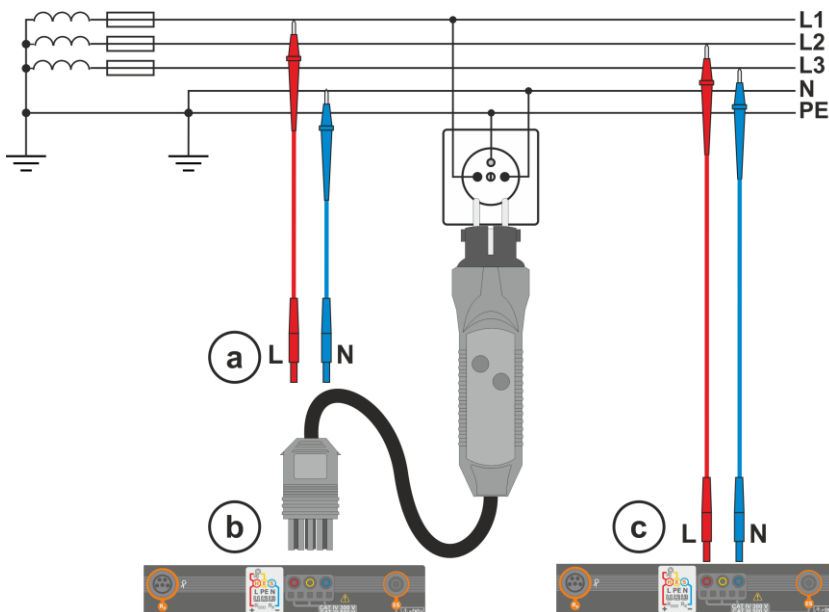

2



Select item  $Z_{L-N, L-L}$ .

3



The measurement screen will appear.

Live mode

$U_{L-N}$  – current voltage between phase and neutral conductors  
 $f$  – current frequency on the tested object

- 4 Enter the measurement settings in accordance with **section 3.4.1**.

5



Press **START** to perform measurement.

6

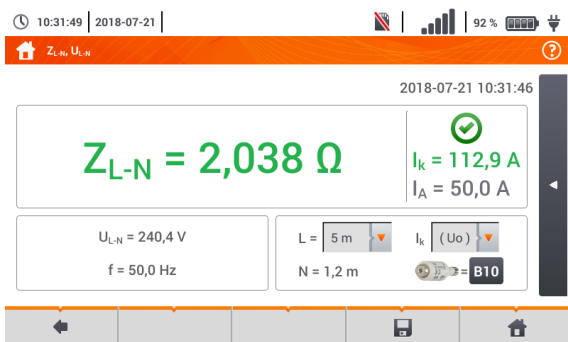

Read out the result.

**Z<sub>L-N</sub>** – the main result  
**I<sub>k</sub>** – prospective short-circuit current with signalling the fulfilment of the acceptable loop criterion (**section 3.4.1**, step **6**):

- met
- not met
- assessment not possible

**I<sub>A</sub>** – current ensuring automatic triggering of a selected protective device within a required time

After selecting the bar on the right side, a menu will show with additional measurement results.

7

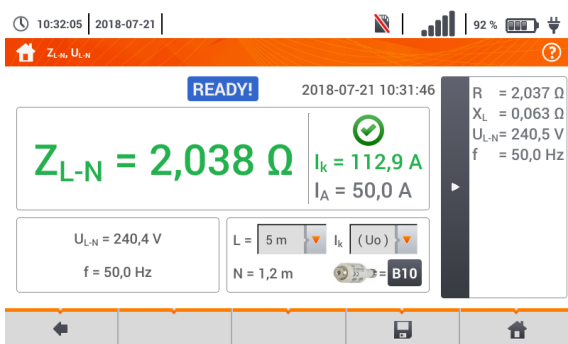

**R** – resistance of the tested circuit  
**X<sub>L</sub>** – reactance of the tested circuit  
**U<sub>L-N</sub>** – voltage relative to the neutral conductor  
**f** – frequency

Selecting the bar hides the menu.

8

Save the measurement to the meter memory using the icon. A detailed description of memory management is contained in **section 5.3**. The last measurement can be recalled using the icon.



- When many measurements are performed in short time intervals, the meter may emit a large amount of heat. As a result of this, the housing of the device may become hot. This is **normal**. In addition, the meter is equipped with the protection against excessive temperature.
- After approx. 15 consecutive measurements of the fault loop wait until the instrument cools down. This limitation is due to the high current measurement and multifunctionality of the meter.
- Minimum **interval** between successive measurements is **5 seconds**. The displayed message **READY!** indicates that it is possible to perform another measurement. Until the message is displayed, the meter prevents any measurements.

## Additional information displayed by the meter

<b>READY!</b>	The meter is ready for measurement.
<b>IN PROGRESS</b>	Measurement in progress.
<b>L-N!</b>	$U_{L-N}$ voltage is incorrect for making a measurement.
<b>L-PE!</b>	$U_{L-PE}$ voltage is incorrect for making a measurement.
<b>N-PE!</b>	$U_{N-PE}$ voltage exceeds allowable value of 50 V.
<b>L ↔ N</b>	Phase connected to N terminal instead of L terminal (for example, exchange of L and N in the mains socket).
<b>TEMPERATURE!</b>	Maximum temperature inside the meter is exceeded.
<b>f!</b>	Network frequency is outside the range of 45...65 Hz.
<b>ERROR!</b>	Error during the measurement. Correct result cannot be displayed.
<b>Loop circuit malfunction!</b>	The meter should be serviced.
<b>U&gt;500V!</b> and continuous audio signal	Before measurement, voltage at test terminals exceeds 500 V.
<b>VOLTAGE!</b>	The voltage on the tested object is not within the limits specified for the set rated voltage of the network $U_n$ ( <b>section 2.2.1</b> step ①).
<b>LIMIT!</b>	Too low value of the prospective short circuit current $I_k$ for the pre-set fuse and time of its triggering.

### 3.4.3 Fault loop parameters in the L-PE circuit

- ① Connect test leads according to **Fig. 3.1** or **Fig. 3.2**.

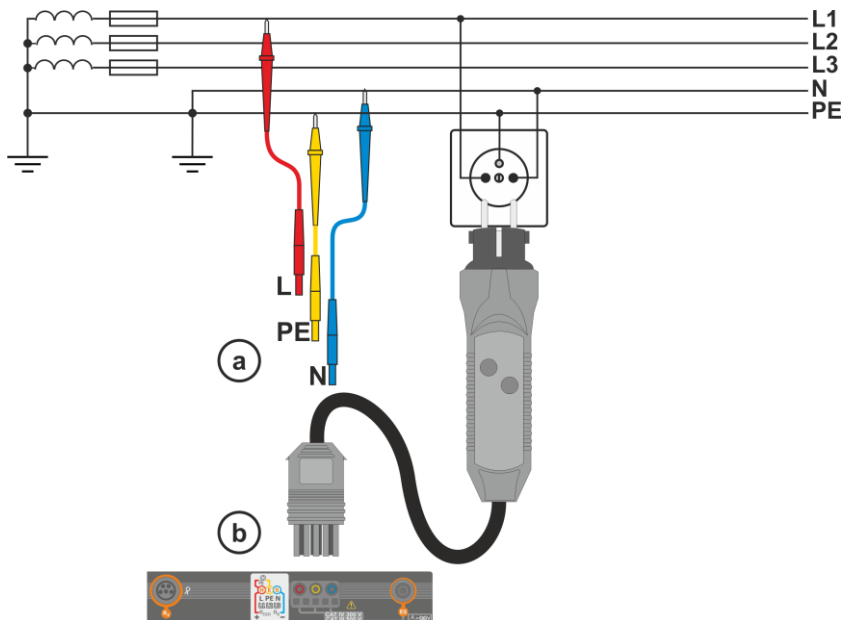

**Fig. 3.1** Measurement in L-PE circuit

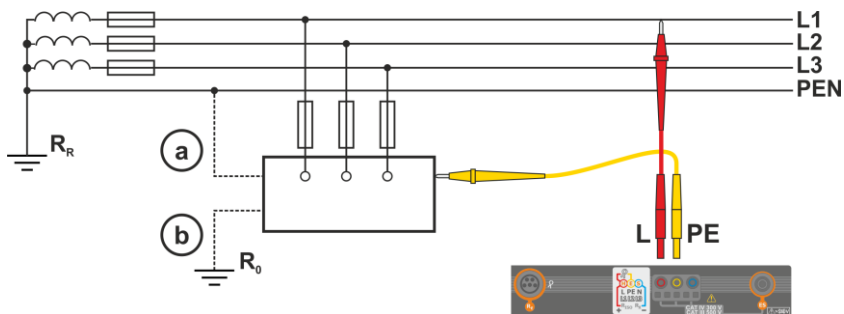

**Fig. 3.2** Checking effectiveness of protection against electric shock of the meter housing in case of: (a) TN network or (b) TT network

- ②



Select item **Z<sub>L-PE</sub>**.

3

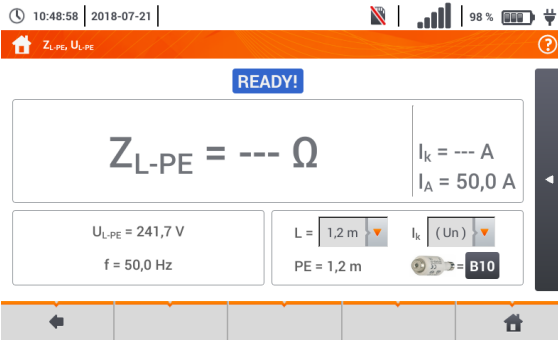

The measurement screen will appear.

Live mode

**U<sub>L-PE</sub>** – current voltage between phase and protective conductors  
**f** – current frequency on the tested object

4

Enter the measurement settings in accordance with **section 3.4.1**.

5



Press the **START** button to perform measurement.

6

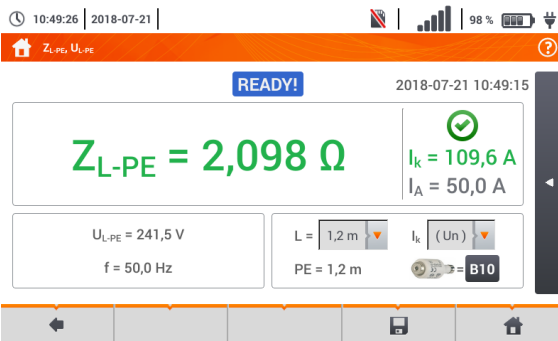

Read out the result.

**Z<sub>L-PE</sub>** – the main result  
**I<sub>k</sub>** – prospective short-circuit current with signalling the fulfilment of the acceptable loop **criterion** (**section 3.4.1**, step 6):

- met
- not met
- assessment not possible

**I<sub>a</sub>** – current ensuring automatic triggering of a selected protective device within a required time

After selecting the bar  on the right side, a menu will slide out with additional measurement results.

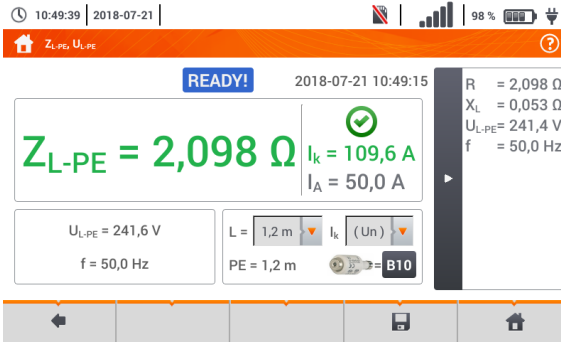

7



**R** – resistance of the tested circuit  
**X<sub>L</sub>** – reactance of the tested circuit  
**U<sub>L-PE</sub>** – voltage relative to the protective conductor  
**f** – frequency

Selecting the bar  hides the menu.

8

Save the measurement to the meter memory using the  icon. A detailed description of memory management is contained in **section 5.3**. The last measurement can be recalled using the  icon.



- Double-lead measurement is not available for the UNI-Schuko adapter.
- When many measurements are performed in short time intervals, the meter may emit a large amount of heat. As a result of this, the housing of the device may become hot. This is **normal**. In addition, the meter is equipped with the protection against excessive temperature.
- After approx. 15 consecutive measurements of the fault loop wait until the instrument cools down. This limitation is due to the high current measurement and multifunctionality of the meter.
- Minimum **interval** between successive measurements is **5 seconds**. The displayed message **READY!** indicates that it is possible to perform another measurement. Until the message is displayed, the meter prevents any measurements.

### 3.4.4 Fault loop impedance in L-PE circuit protected with a residual current device (RCD)

- 1 Connect test leads according to Fig. 3.3 , Fig. 3.4 lub Fig. 3.5.

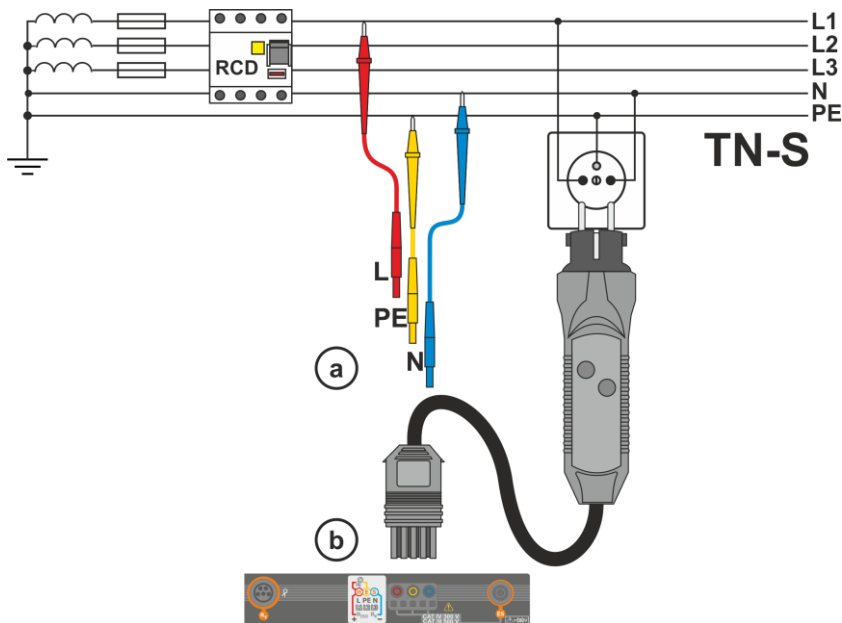

Fig. 3.3 Measurement in the TN-S system

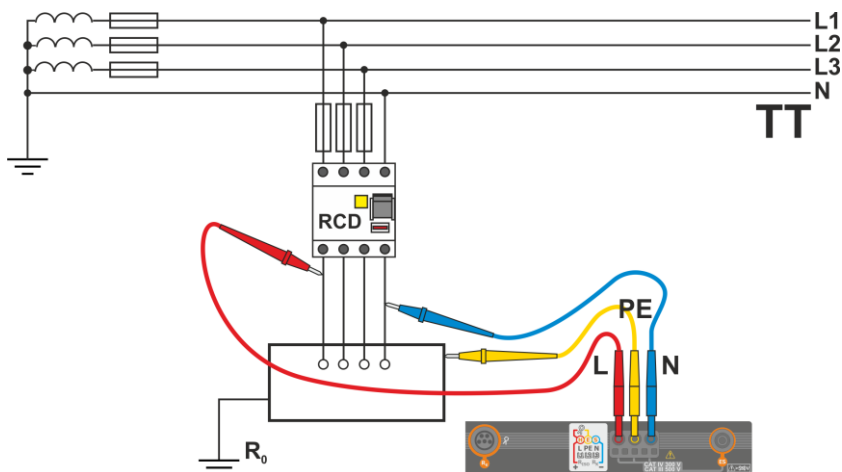

Fig. 3.4 Measurement in the TT system

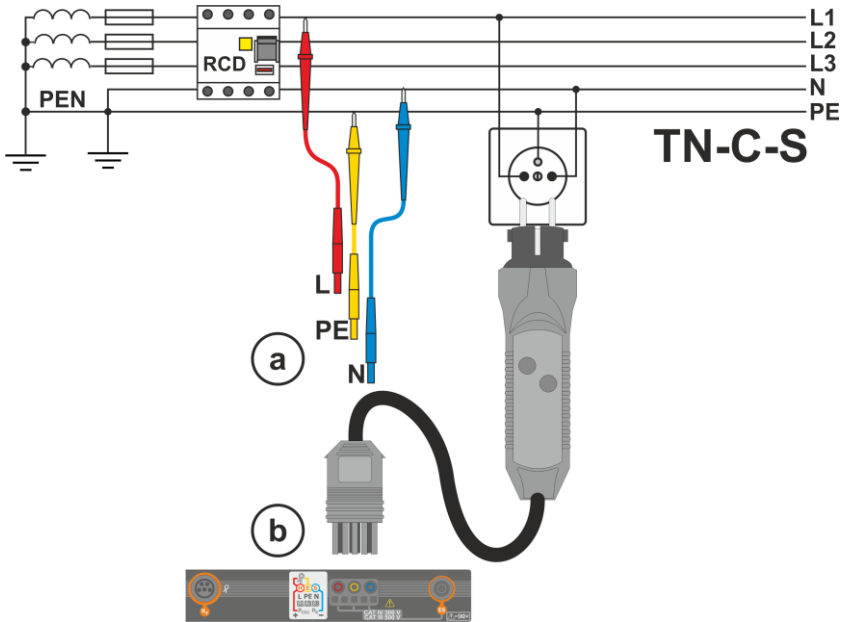

Fig. 3.5 Measurement in the TN-C-S system

2



Select item  $Z_{L-PE[RCD]}$ .

3

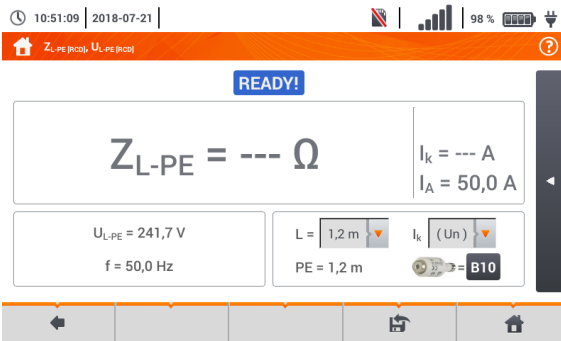

The measurement screen will appear.

Live mode  
 $U_{L-PE}$  – current voltage between phase and protective conductors  
 $f$  – current frequency on the tested object

4

Enter the measurement settings in accordance with **section 3.4.1**.

5



Press the **START** button to perform measurement.

6

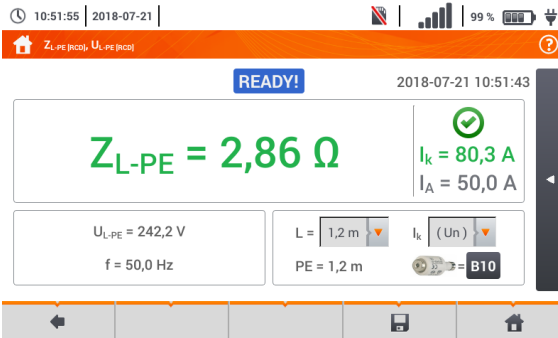

Read out the result.

$Z_{L-PE}$  – the main result  
 $I_k$  – prospective short-circuit current with signalling the fulfilment of the acceptable loop criterion (**section 3.4.1**, step ⑥):

- ✓ met
- ✗ not met
- ⊖ assessment not possible

$I_a$  – current ensuring automatic triggering of a selected protective device within a required time

After selecting the bar ◀ on the right side, a menu will slide out with additional measurement results.

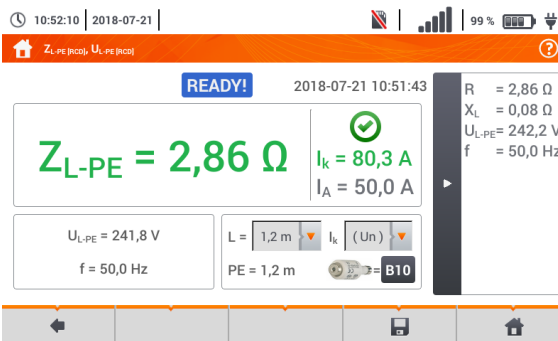

7



**R** – resistance of the tested circuit  
**X<sub>L</sub>** – reactance of the tested circuit  
**U<sub>L-PE</sub>** – voltage relative to the protective conductor  
**f** – frequency

Selecting the bar ▶ hides the menu.

8

Save the measurement to the meter memory using the  icon. A detailed description of memory management is contained in **section 5.3**. The last measurement can be recalled using the  icon.



- Maximum measurement time is few seconds. The measurement can be interrupted by pressing the  button.
- In the electrical installations with 30 mA RCD's, the sum of leakage currents of the installation and the test current may trigger the RCD. If this happens, try to reduce the leakage current in the tested mains (for example by disconnecting loads).
- The function works for residual current devices of rated current  $\geq 30$  mA.
- When many measurements are performed in short time intervals, the meter may emit a large amount of heat. As a result of this, the housing of the device may become hot. This is **normal**. In addition, the meter is equipped with the protection against excessive temperature.
- After approx. 15 consecutive measurements of the fault loop wait until the instrument cools down. This limitation is due to the high current measurement and multi-functionality of the meter.
- Minimum **interval** between successive measurements is **5 seconds**. The displayed message **READY!** indicates that it is possible to perform another measurement. Until the message is displayed, the meter prevents any measurements.

### 3.4.5 Prospective short-circuit current

The meter always measures fault loop impedance  $Z_s$  and the displayed short-circuit current is calculated according to the following formula:

$$I_k = \frac{U}{Z_s}$$

where:

$Z_s$  – measured impedance,

$U$  – voltage dependent on the network rated voltage settings  $U_n$  (section 3.4.1 point ④):

$I_k(U_n)$	$U = U_n$
$I_k(U_0)$	$U = U_0$ for $U_0 < U_n$
	$U = U_n$ for $U_0 \geq U_n$

where:

$U_n$  – nominal voltage of the network,

$U_0$  – voltage measured by the meter.

On the basis of  $U_n$  rated voltage selected (section 2.2.1), the meter automatically recognizes the measurement at phase voltage or phase-to-phase voltage and takes it into account in the calculations.

If the voltage of the network being tested is outside the tolerance range, the meter will not be able to determine a proper rated voltage for the short-circuit current calculation. In such a case, --- will be displayed instead of short-circuit current value. Fig. 3.6 shows voltage ranges for which short-circuit current value is calculated.

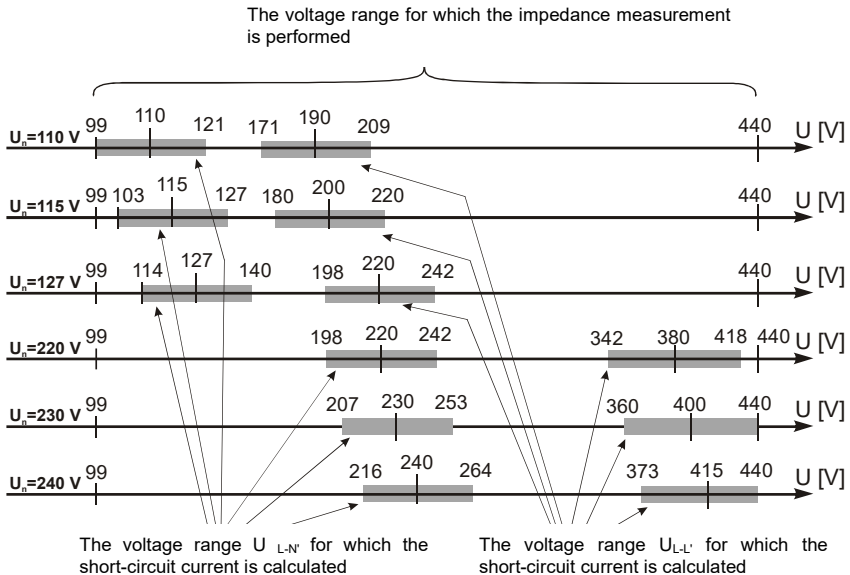

Fig. 3.6 Measuring voltage ranges

### 3.4.6 Measurement of fault loop impedance in IT networks

Before performing the measurements in the **Measurement settings** menu select the appropriate network type (**section 2.2.1**).



#### NOTE!

- After selecting an IT type network, the function of the contact electrode is **inactive**.
- When attempting to perform the  $Z_{L-PE}$  and  $Z_{L-PE[RCD]}$  **measurement** a message will appear informing that the measurement is impossible.

The manner of connecting the device to the installation is shown in **Fig. 3.7**.

The manner of performing the fault loop measurements is described in **section 3.4.2**.

Operating voltage range: **95 V ... 440 V**.

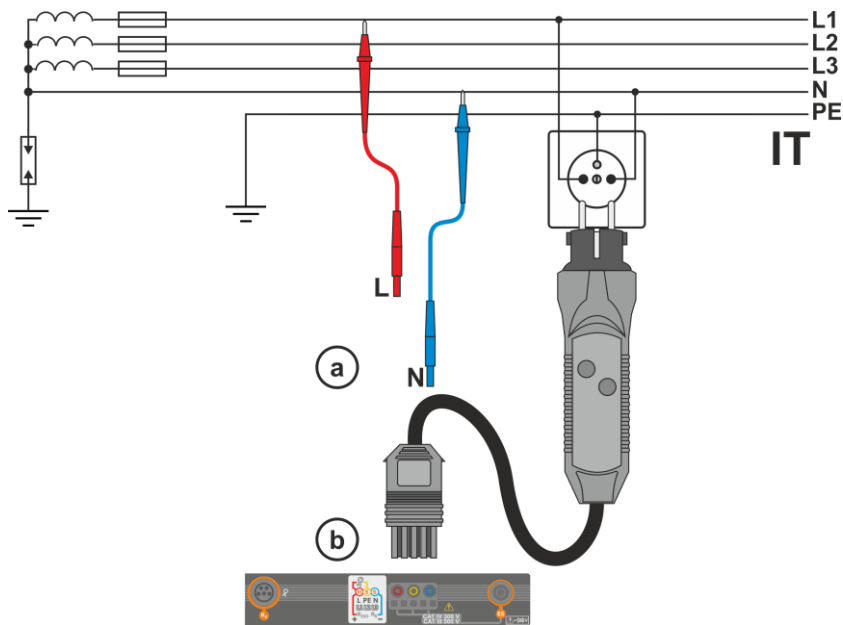

**Fig. 3.7 Measurement in the IT system**

### 3.5 Voltage drop

This function determines the voltage drop between two points of the tested network, selected by the user. The test is based on measurement of fault loop impedance L-N at these points. In a standard network, usually the voltage drop is tested between the socket and the switchgear (reference point).

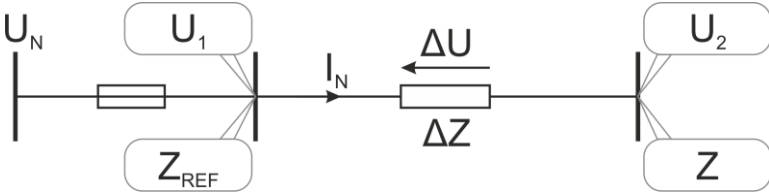

The voltage drop is calculated according to the following formula:

$$\Delta U = \frac{(Z - Z_{REF}) \cdot I_N}{U_N} \cdot 100\%$$

where:

- Z – fault loop impedance at the destination point,
- Z<sub>REF</sub> – fault loop impedance at the reference point,
- I<sub>N</sub> – rated fuse current
- U<sub>N</sub> – rated mains voltage.

1

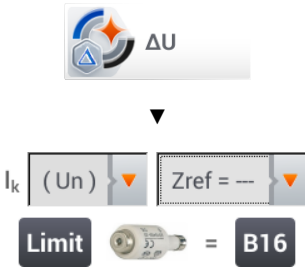

- Select item **ΔU**.
- Use setting **Zref= --** to reset previous measurement, if it has not been done yet.
- Enter the **limit** of voltage drop **ΔU<sub>MAX</sub>**.
- Enter the **fuse type**, which protects the tested circuit.

2

- Connect the meter to the reference point of the tested network, as for Z<sub>L-N</sub> measurement
- Press **START**.

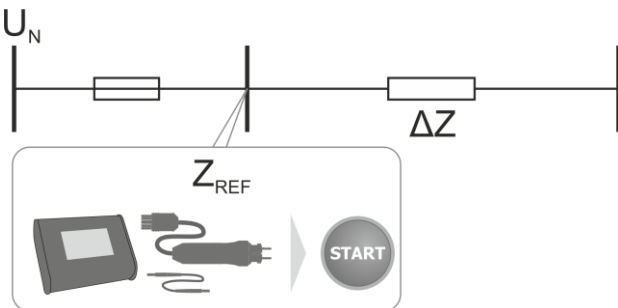

- 3 • Change the setting from **Zref** to **Z**.
- Connect the meter to the reference point, as for  $Z_{L-N}$  measurement.
- Press **START**.

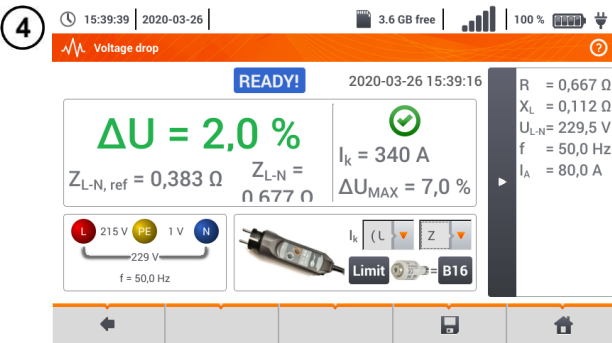
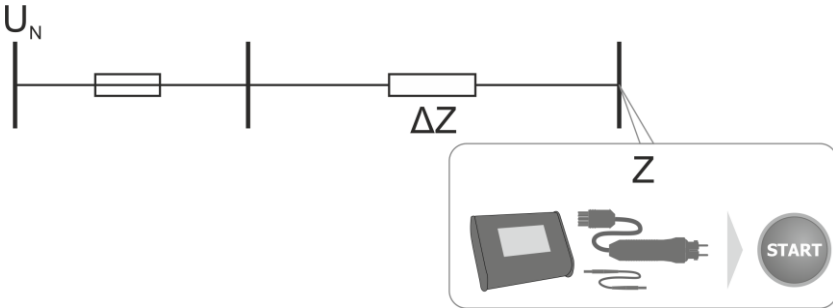

Read out the result.

$\Delta U$  – the main result and indication of meeting **criterion**  $\Delta U_{MAX}$ :



- **green:**  $\Delta U \leq \Delta U_{MAX}$
- **red:**  $\Delta U > \Delta U_{MAX}$

$I_k$  – prospective short-circuit current

After selecting the bar  on the right side, a menu will slide out with additional measurement results.

- R** – resistance of the tested circuit
- $X_L$**  – reactance of the tested circuit
- $U_{L-N}$**  – voltage relative to the neutral conductor
- f** – frequency
- $I_A$**  – protection tripping current

Selecting the  bar hides the menu.

- 5 Save the measurement to the meter memory using the  icon. A detailed description of memory management is contained in **section 5.3**. The last measurement can be recalled using the  icon.



If  $Z_{REF}$  is greater than  $Z$ , then the meter indicates  $\Delta U = 0\%$

## 3.6 Resistance-to-earth

### 3.6.1 Settings of measurements

①



Select item **R<sub>E</sub>**.

②

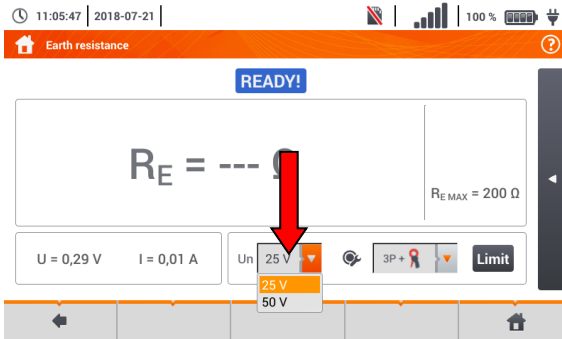

Touch the parameter drop-down menu **Un** (measuring voltage selection).

Select the required measuring voltage from the list.

③



Touch the drop-down menu of measurement method selection.

#### Available measurement methods

- ⇒ 3-pole
- ⇒ 4-wire
- ⇒ 3-pole + receiving clamp
- ⇒ 2-clamp (transmitting + receiving clamp)

④



Select **Limit** to set the resistance limit.

- Select unit.

- Enter the required resistance limit value:

- ⇒ 0.00...1990 for Ω,
- ⇒ 0.00...2 for kΩ.

#### Functions of icons

- reject changes and exit to the previous screen
- accept changes

### 3.6.2 Earth resistance measurement with 3-pole method ( $R_{E3P}$ )

The three-pole measuring method is the basic type of resistance-to-earth measurement.

- 1 Disconnect the tested earth electrode from the installation of the facility.

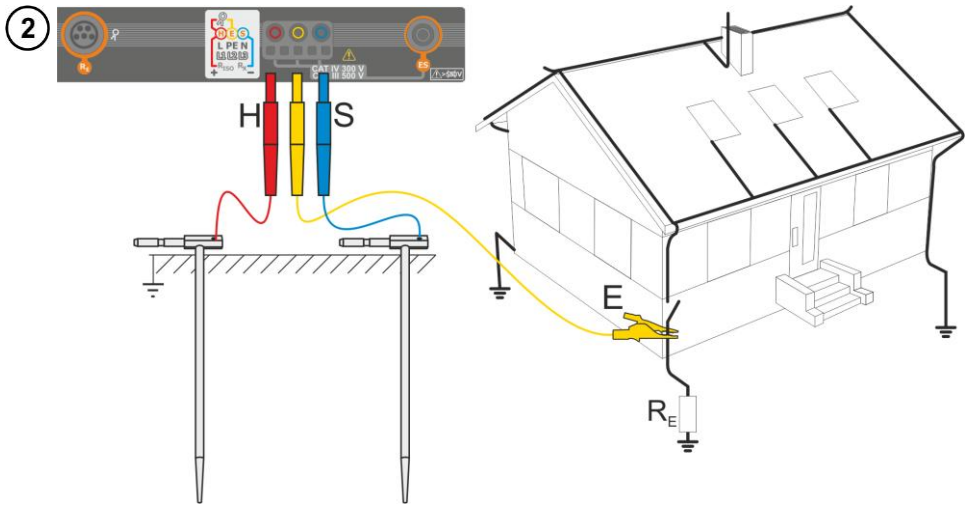
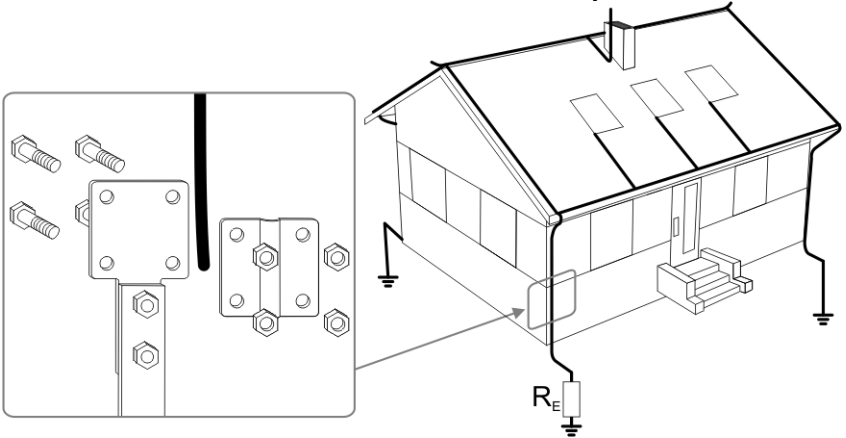

- Drive the **current** electrode into the earth and connect to the **H** socket of the meter.
- Drive the **voltage** electrode into the earth and connect to the **S** socket of the meter.
- The **earth electrode** being tested should be connected to **E** socket of the meter.
- It is recommended that the tested **earth electrode** as well as **H** and **S** electrodes should be located along one line and at relevant distances, in accordance with the rules of earth measurements.

3



- Select the **3P** option in the measurement menu.
- Select other settings in accordance with **section 3.6.1**.

4



The meter is ready for measurement.

Live mode

**U** – interference voltage currently on the object

Limits

**R<sub>E</sub> MAX** – currently set earth resistance limit

5



Press **START** to start the measurement.

6

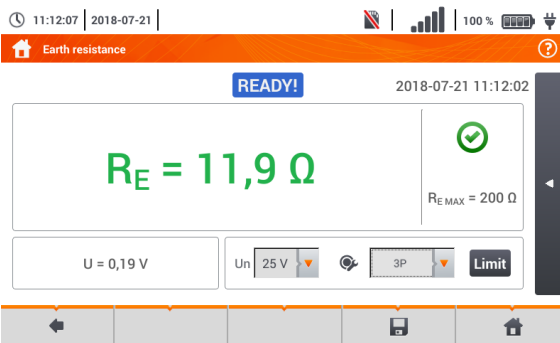

Read out the result.

Signal lights for reaching the limit (section 3.6.1 step 6)

- ✔ the result is within the set limit
- ✘ the result is outside the set limit
- ⊖ assessment not possible

After selecting the bar ◀ on the right side, a menu will slide out with additional measurement results.

7

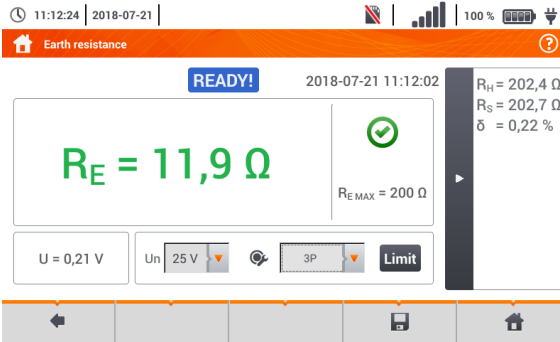



$R_H$  – resistance of current electrode

$R_S$  – resistance of voltage electrode  
 $\delta$  – additional uncertainty caused by resistance of the electrodes

Selecting the  bar hides the menu.

8

Save the measurement to the meter memory using the  icon. A detailed description of the memory management is contained in **section 5.3**.

The last measurement can be recalled using the  icon.

9

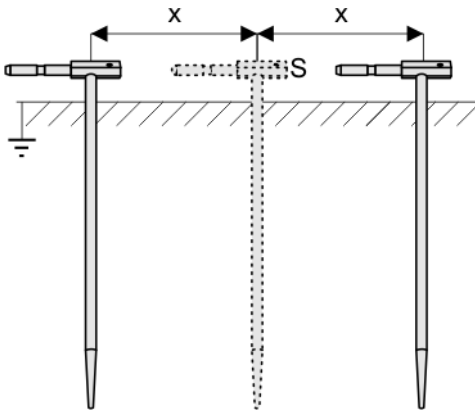

Repeat the steps **(2)(5)(6)** for two additional locations of the voltage electrode **S**:

- **located at a** certain distance from the tested earth electrode,
- **moved closer** by the same distance to the tested electrode.

This is done to confirm that the **S** electrode was driven into the reference earth. If so, **the difference between the value of  $R_E$  and each additional measurement should not exceed 3%**.

If  $R_E$  measurement results differ from one another by more than 3%, the distance of the current electrode from the earth electrode being tested **should be considerably increased** and the measurements should be repeated.



#### WARNING

- Measurement of resistance-to-earth may be carried out if voltage of interferences does not exceed 24 V. Voltage of interferences is measured up to the level of 100 V.
- Over 50 V it is signalled as hazardous. The meter must not be connected to voltages exceeding 100 V.



- It is recommended that the test **earth electrode** as well as **H** and **S** electrodes should be located in one line. Due to the different field conditions it is not always possible. On the manufacturer's website and in professional literature special cases of probes location have been discussed.
- Particular attention should be paid to quality of connection between the object being tested and the test lead – the contact area must be free from paint, rust, etc.
- If **resistance of test probes is too high**,  $R_E$  earth electrode measurement will **include an additional uncertainty**. Particularly high uncertainty of measurement occurs when the tested resistance is small, and the probes have a weak contact with earth (such a situation occurs frequently when the earth electrode is well made but the upper soil layer is dry and slightly conductive). Then, the ratio of resistance of the probes to resistance of the tested earth electrode is very high and consequently, uncertainty of  $\delta$  measurement that depends on this ratio is also very high.
- To reduce the uncertainty of the  $\delta$ , measurement, the contact of the probe with earth may be improved, for example, by:
  - moistening the spot where the probe is driven with water,
  - driving the probe in a different location,
  - applying an 80 cm probe.

Also, test the test leads for:

- whether their insulation is not defective
- whether the lead – banana plug – probe contact areas are not corroded or loosened.

In majority of cases the achieved measurement accuracy is satisfactory. However, you should always take account of the uncertainty included in the measurement.

## Additional information displayed by the meter

<b>READY!</b>	The meter is ready for measurement.
<b>IN PROGRESS</b>	Measurement in progress.
<b>VOLTAGE!</b>	Too high voltage at the meter terminals.
<b>H!</b>	Interruption in the test probe circuit.
<b>S!</b>	Interruption in the voltage probe circuit.
<b><math>R_E &gt; 1.99 \text{ k}\Omega</math></b>	Measuring range is exceeded.
<b>NOISE!</b>	Signal / noise ratio is too low (interfering signal too large).
<b>LIMIT!</b>	Error due to the resistance of electrodes > 30 % (for calculating uncertainty, measured values are taken into account).
	Interruption in measuring circuit or resistance of test probes is higher than 60 k $\Omega$ .

### 3.6.3 Earth resistance measurement with 4-wire method ( $R_{E4P}$ )

Four-pole method is recommended for use in the measurement of earth resistance of very small values. It allows user to eliminate the influence of resistance of test leads on the measurement results. It is also suitable for determining the resistivity of the soil. However, it is recommended that the dedicated function should be used for this measurement (**section 3.7**).

- 1 Disconnect the tested earth electrode from the installation of the facility.

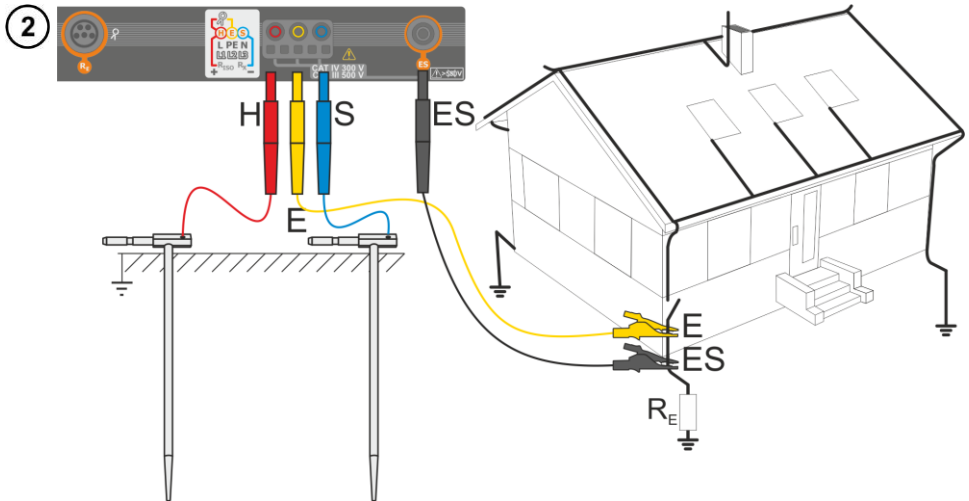
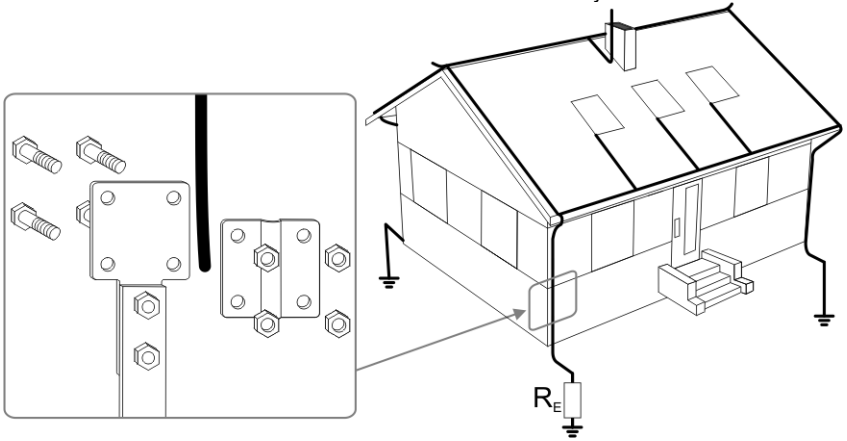

- Drive the **current** electrode into the earth and connect to the **H** socket of the meter.
- Drive the **voltage** electrode into the earth and connect to the **S** socket of the meter.
- The earth electrode being tested should be connected to **E** socket of the meter with the lead.
- **ES** socket should be connected to the tested earth electrode below **E** lead.

- It is recommended that the tested **earth electrode** as well as **H** and **S** electrodes should be located along one line and at relevant distances, in accordance with the rules of earth measurements.

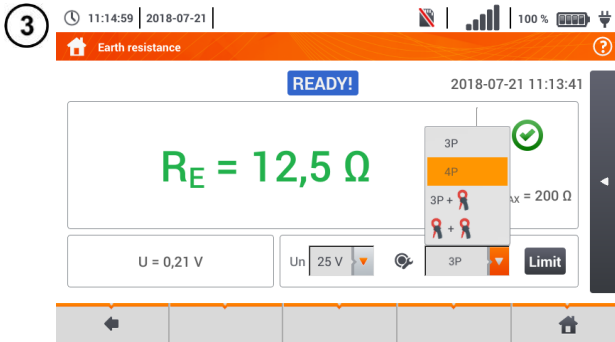

- Select the **4P** option in the measurement menu.

- Select other settings in accordance with **section 3.6.1**.

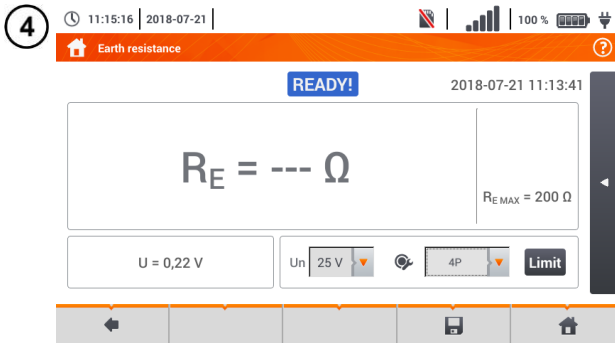

The meter is ready for measurement.

Live mode

**U** – interference voltage currently on the object

Limits

**R<sub>E</sub> MAX** – currently set earth resistance limit



Press **START** to start the measurement.

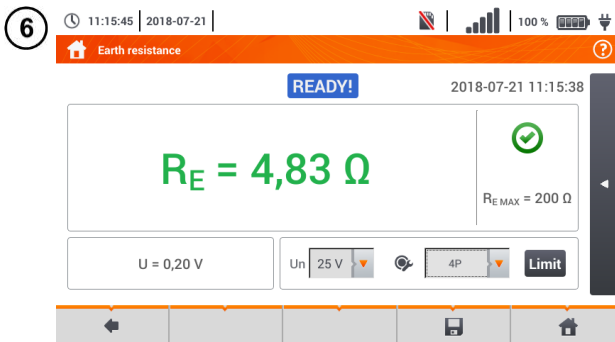

Read out the result.

Signal lights for reaching the limit (**section 3.6.1** step (6)):

- the result is within the set limit
- the result is outside the set limit
- assessment not possible

After selecting the bar on the right side, a menu will slide out with additional measurement results.

7

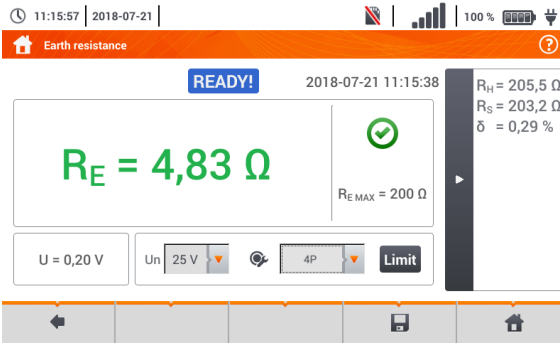

$R_H$  – resistance of current electrode

$R_S$  – resistance of voltage electrode

$\delta$  – additional uncertainty caused by resistance of the electrodes

Selecting the  bar hides the menu.

8

Save the measurement to the meter memory using the  icon. A detailed description of the memory management is contained in **section 5.3**.

The last measurement can be recalled using the  icon.

9

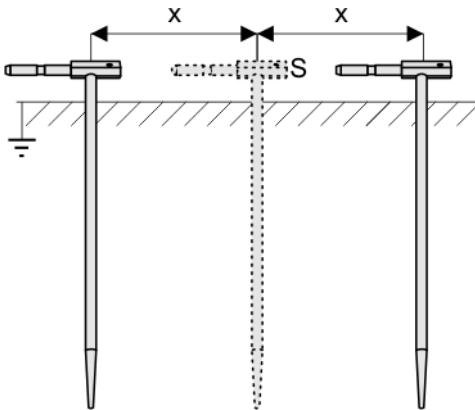

Repeat the steps **2** **5** **6** for two additional locations of the voltage electrode S:

- **at** a certain distance from the tested earth electrode,
- **moved closer** by the same distance to the tested earth electrode.

This is done to confirm that the **S** electrode was driven into the reference earth. If so, **the difference between the value of  $R_E$**  between the main measurement and each additional measurement **should not exceed 3%**.

If  $R_E$  measurement results differ from one another by more than 3%, the distance of the current electrode from the earth electrode being tested **should be considerably increased** and the measurements should be repeated.



**WARNING**

- Measurement of resistance-to-earth may be carried out if voltage of interferences does not exceed 24 V. Voltage of interferences is measured up to the level of 100 V.
- Over 50 V it is signalled as hazardous. The meter must not be connected to voltages exceeding 100 V.



- It is recommended that the test **earth electrode** as well as **H** and **S** electrodes should be located in one line. Due to the different field conditions it is not always possible. On the manufacturer's website and in professional literature special cases of probes location have been discussed.
- - Particular attention should be paid to quality of connection between the object being tested and the test lead – the contact area must be free from paint, rust, etc.
- If **resistance of test probes is too high**,  $R_E$  earth electrode measurement will **include an additional uncertainty**. Particularly high uncertainty of measurement occurs when the tested resistance is small, and the probes have a weak contact with earth (such a situation occurs frequently when the earth electrode is well made but the upper soil layer is dry and slightly conductive). Then, the ratio of resistance of the probes to resistance of the tested earth electrode is very high and consequently, uncertainty of  $\delta$  measurement that depends on this ratio is also very high. Then, in accordance with the formulas from **section 10.4.4**, calculations can be made to estimate the influence of measurement conditions.
- To reduce the uncertainty of the  $\delta$ , measurement, the contact of the probe with earth may be improved, for example, by:
  - o moistening the spot where the probe is driven with water,
  - o driving the probe in a different location,
  - o applying an 80 cm probe.Also, test the test leads for:
  - o whether their insulation is not defective
  - o whether the lead – banana plug – probe contact areas are not corroded or loosened.In majority of cases the achieved measurement accuracy is satisfactory. However, you should always take account of the uncertainty included in the measurement.

## Additional information displayed by the meter

<b>READY!</b>	The meter is ready for measurement.
<b>IN PROGRESS</b>	Measurement in progress.
<b>VOLTAGE!</b>	Too high voltage at the meter terminals.
<b>H!</b>	Interruption in the test probe circuit.
<b>S!</b>	Interruption in the voltage probe circuit.
<b>RE&gt;1.99 kΩ</b>	Measuring range is exceeded.
<b>NOISE!</b>	Signal / noise ratio is too low (interfering signal too large).
<b>LIMIT!</b>	Error due to the resistance of electrodes > 30 % (for calculating uncertainty, measured values are taken into account).
	Interruption in measuring circuit or resistance of test probes is higher than 60 kΩ.

### 3.6.4 Earth resistance measurement with 3-pole method with additional clamp ( $R_{E3P+C}$ )

1

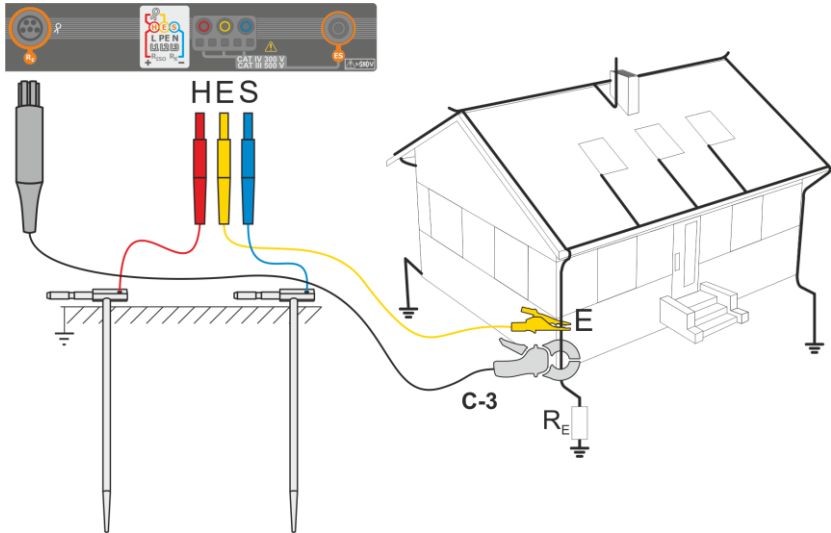

- Drive the **current** electrode into the earth and connect to the **H** socket of the meter.
- Drive the **voltage** electrode into the earth and connect to the **S** socket of the meter.
- The earth electrode being tested should be connected to **E** socket of the meter with the lead.
- It is recommended that the tested **earth electrode** as well as **H** and **S** electrodes should be located along one line and at relevant distances, in accordance with the rules of earth measurements.
- **Receiving clamps** should be attached to the tested earth electrode below the connection point of **E** lead.
- **The arrow on the clamps** can be directed **in any direction**.

2

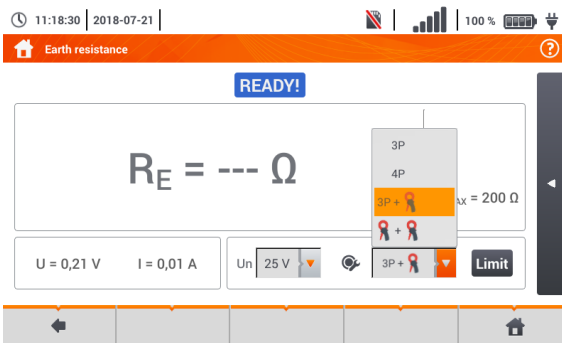

Select the **3P + clamps** option in the measurement menu.

Select other settings in accordance with **section 3.6.1**.

3 11:18:44 | 2018-07-21 | The meter is ready for measurement.

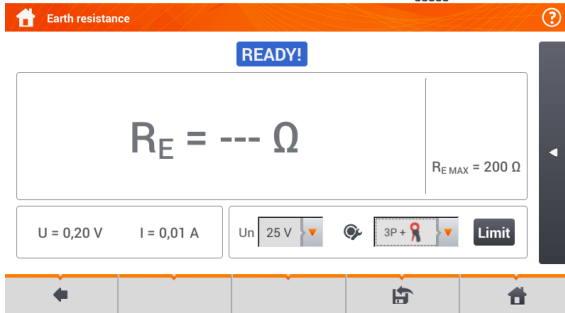

**Live mode**  
**U** – interference voltage currently on the object  
**I** – interference current currently flowing through the object

**Limits**  
**R<sub>E</sub> MAX** – currently set earth resistance limit



Press **START** to start the measurement.

5 11:19:08 | 2018-07-21 | Read out the result.

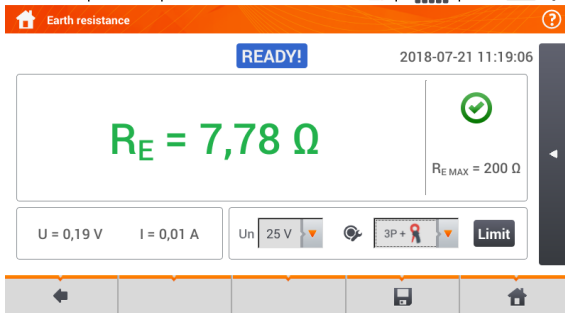

**Signal lights for the limit (section 3.6.1 step (6))**

- the result is within the set limit
- the result is outside the set limit
- assessment not possible

After selecting the bar on the right side, a menu will slide out with additional measurement results.

6 11:19:20 | 2018-07-21 | **R<sub>H</sub>** – resistance of current electrode



**R<sub>S</sub>** – resistance of voltage electrode  
**δ** – additional uncertainty caused by resistance of the electrodes

Selecting the bar hides the menu.

7 Save the measurement to the meter memory using the icon. A detailed description of memory management is contained in **section 5.3**. The last measurement can be recalled using the icon.

8

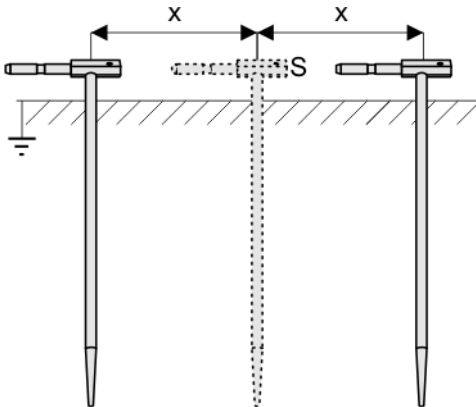

Repeat the steps ② ⑤ ⑥ for two additional locations of the voltage electrode S:

- **located** at a certain distance from the tested earth electrode,
- **moved closer** by the same distance to the tested earth electrode.

This is done to confirm that the **S** electrode was driven into the reference earth. If so, **the difference between the value of  $R_E$  between the main measurement and each additional measurement should not exceed 3%**.

If  $R_E$  measurement results differ from one another by more than 3%, the distance of the current electrode from the earth electrode being tested **should be considerably increased** and the measurements should be repeated.



#### WARNING

- **Measurement of resistance-to-earth may be carried out if voltage of interferences does not exceed 24 V. Voltage of interferences is measured up to the level of 100 V.**
- **Over 50 V it is signalled as hazardous. The meter must not be connected to voltages exceeding 100 V.**



- It is recommended that the test **earth electrode** as well as **H** and **S** electrodes should be located in one line. Due to the different field conditions it is not always possible. On the manufacturer's website and in professional literature special cases of probes location have been discussed.
- Use **C-3 clamps** for the measurement.
- Maximum interference current: 1 A.
- Particular attention should be paid to quality of connection between the object being tested and the test lead – the contact area must be free from paint, rust, etc.
- If **resistance of test probes is too high**,  $R_E$  earth electrode measurement will **include an additional uncertainty**. Particularly high uncertainty of measurement occurs when a small value of resistance-to-earth is measured with probes that have a weak contact with earth (such a situation occurs frequently when the earth electrode is well made and the upper soil layer is dry and slightly conductive). Then, the ratio of resistance of the probes to resistance of the tested earth electrode is very high and consequently, uncertainty of measurement that depends on this ratio is also very high. Then, in accordance with the formulas from **section 10.4.4**, calculations can be made to estimate the influence of measurement conditions. To reduce the uncertainty of the  $\delta$ , measurement, the contact of the probe with earth may be improved, for example, by:

- o moistening the spot where the probe is driven with water,
- o driving the probe in a different location,
- o applying an 80 cm probe.



Also, test the test leads for:

- o whether their insulation is not defective
- o whether the lead – banana plug – probe contact areas are not corroded or loosened.

In majority of cases the achieved measurement accuracy is satisfactory. However, you should always take account of the uncertainty included in the measurement.

- Factory calibration does not include the resistance of the test leads. The result displayed by the meter is a sum of the resistance of the measured object and the resistance of leads.

## Additional information displayed by the meter

<b>READY!</b>	The meter is ready for measurement.
<b>IN PROGRESS</b>	Measurement in progress.
<b>VOLTAGE!</b>	Too high voltage at the meter terminals.
<b>R<sub>E</sub>&gt;1.99 kΩ</b>	Measuring range is exceeded.
<b>NOISE!</b>	Signal / noise ratio is too low (interfering signal too large).
<b>LIMIT!</b>	Error due to the resistance of electrodes > 30 % (for calculating uncertainty, measured values are taken into account).
	Interruption in measuring circuit or resistance of test probes is higher than 60 kΩ.
<b>H!</b>	Interruption in the test probe circuit.
<b>S!</b>	Interruption in the voltage probe circuit.
	Too small test current.
	No continuity in the current clamps circuit.

### 3.6.5 Earth resistance measurement with two-clamp method (2C)



- The double-clamp measurement may be applied where there is no possibility to use electrodes driven into the ground.
- The double-clamp method may only be used when measuring **multiple earthing** (it is necessary to provide a return path for the test current).
- For ring earth electrodes (step ① variant ②) the method allows **switching off to determine continuity** of the measured earth electrode point with the rest of the earth electrode.

① ②

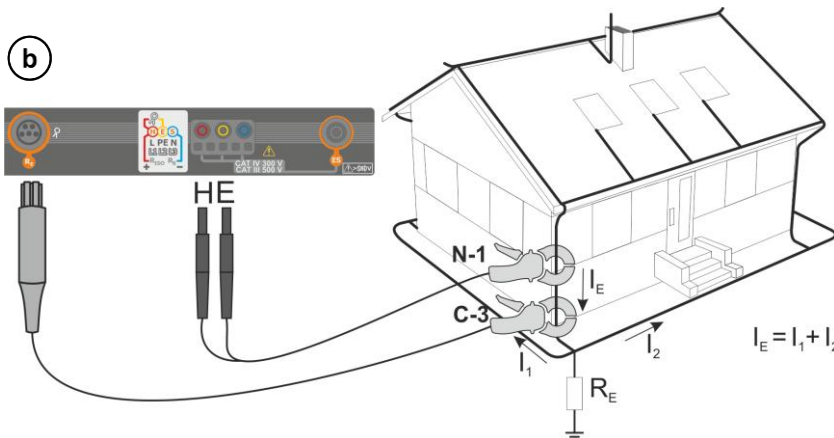
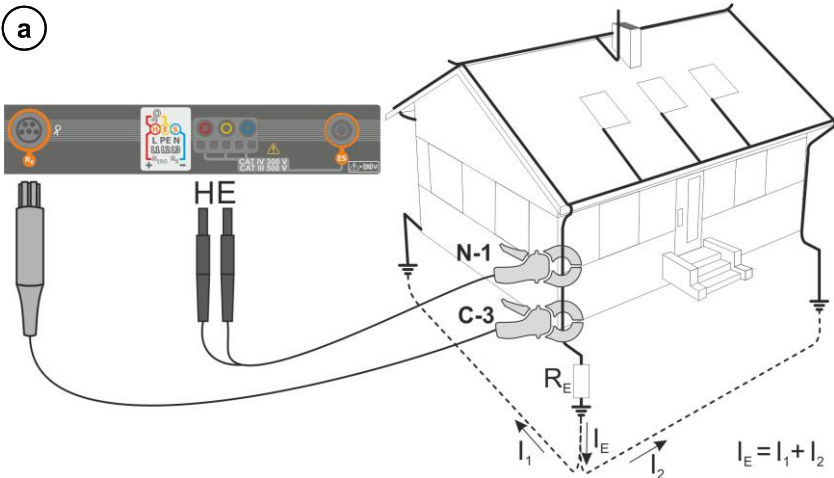

- Transmitting clamps and measuring clamps should be attached to the tested earth electrode **at a distance of at least 30 cm from each other**.
- **The arrow on the clamps can be directed in any direction.**
- Connect the transmitting clamps N-1 to H and E socket.
- Connect the **measuring clamps C-3** to the clamp socket.

2



- Select the **clamps + clamps** option in the measurement menu.

- Select other settings in accordance with **section 3.6.1**.

3

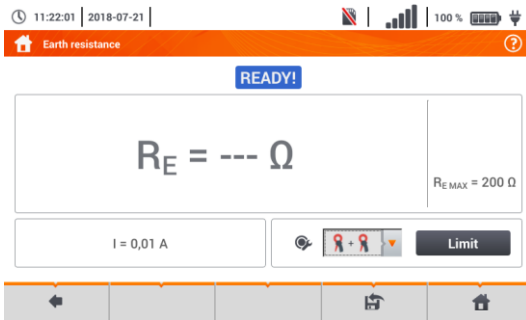

The meter is ready for measurement.

Live mode

I – interference current currently flowing through the object

Limits

R<sub>E</sub> MAX – currently set earth resistance limit

4



Press **START** to start the measurement.

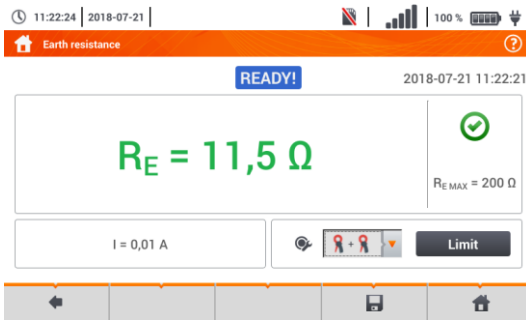



Read out the result.

Signal lights for the limit (section 3.6.1 step 6)

- ✔ the result is within the set limit
- ✘ the result is outside the set limit
- ⊖ assessment not possible

5



Save the measurement to the meter memory using the  icon. A detailed description of memory management is contained in **section 5.3**.

The last measurement can be recalled using the  icon.



- Measurements may be performed in the presence of interference current of a value not exceeding 3 A RMS and frequency in accordance with the value set in sub-menu **Measurement settings** (section 2.2.1 step ①).
- Use **N-1 clamps** as signal transmitting clamps and **C-3 clamps** as receiving clamps.
- If the current on measuring clamps is too low, the meter displays the following message: **The current measured by clamps is too low. Measurement is not possible!**
- Maximum interference current: 1 A.

## Additional information displayed by the meter

<b>READY!</b>	The meter is ready for measurement.
<b>IN PROGRESS</b>	Measurement in progress.
<b>R<sub>E</sub>&gt;99.9Ω</b>	Measuring range is exceeded.
<b>NOISE!</b>	Signal / noise ratio is too low (interfering signal too large).
<b>LIMIT!</b>	Error due to the resistance of electrodes > 30 % (for calculating uncertainty, measured values are taken into account).
	Too small test current.
	No continuity in the current clamps circuit.

### 3.7 Soil resistivity

For soil resistivity measurements – used as preparation for the designing the earthing system or in geology measurements – a separate function is provided: measurement of soil resistivity  $\rho$ . This function is identical to 4-wire measurement of earth resistance, however, it contains an additional procedure of entering the distance between the electrodes. The measurement result is the resistivity value, calculated automatically according to the formula applied in Wenner method:

$$\rho = 2\pi LR_E$$

where:

L – distance between the electrodes (all distances must be equal),  
 $R_E$  – measured resistance.

#### 3.7.1 Settings of measurements

1



Select item  $\Omega m$ .

2

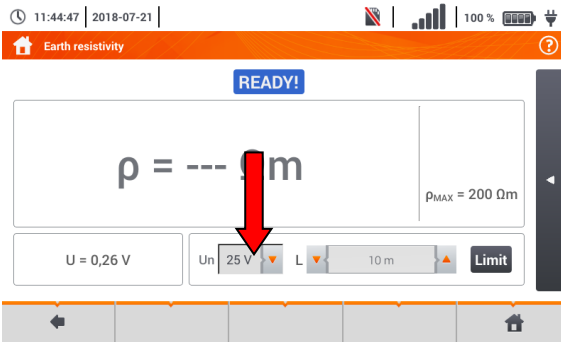

Touch the parameter drop-down menu  $U_n$  (measuring voltage selection).

3

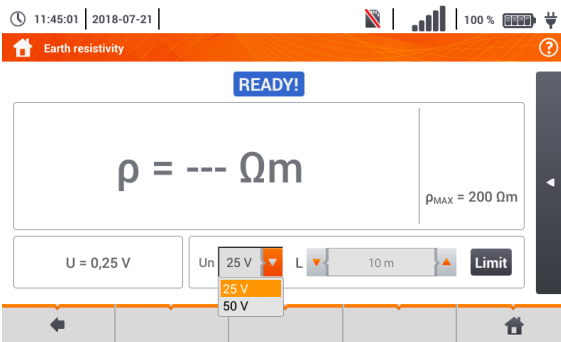

Select the required measuring voltage from the list.

4

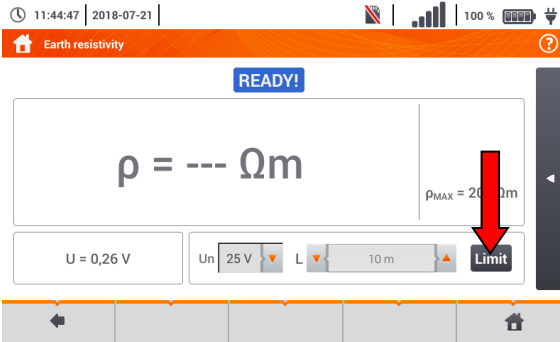

Select **Limit** to set the soil resistivity limit.

5

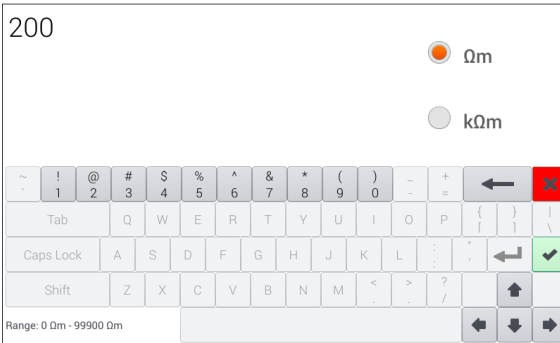

- Select unit.
- Enter the required resistance limit value:  
⇒ **Ωm**: 0...99 900,  
⇒ **kΩm**: 0...100.

**Functions of icons**

- reject changes and exit to the previous screen
- accept changes

### 3.7.2 Main elements of the screen

1



Select item **Soil resistivity Ωm**.

2

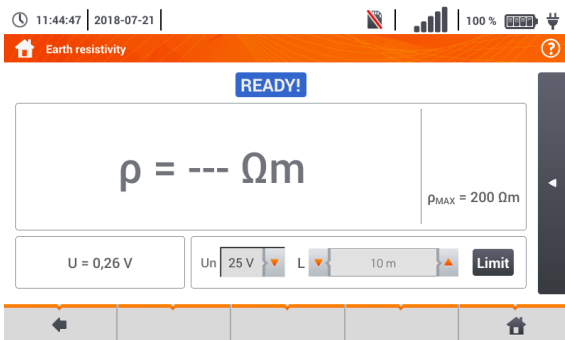

The measurement screen will appear.

Live mode

**U** – interference voltage

Limits

**ρMAX** – soil resistivity limit

After selecting the bar on the right side, a menu will slide out with additional measurement results.

3



$R_H$  – resistance of current electrode  
 $R_S$  – resistance of voltage electrode  
 $\delta$  – additional uncertainty caused by resistance of the electrodes

Selecting the  bar hides the menu.

### 3.7.3 Soil resistivity measurements ( $\rho$ )

1

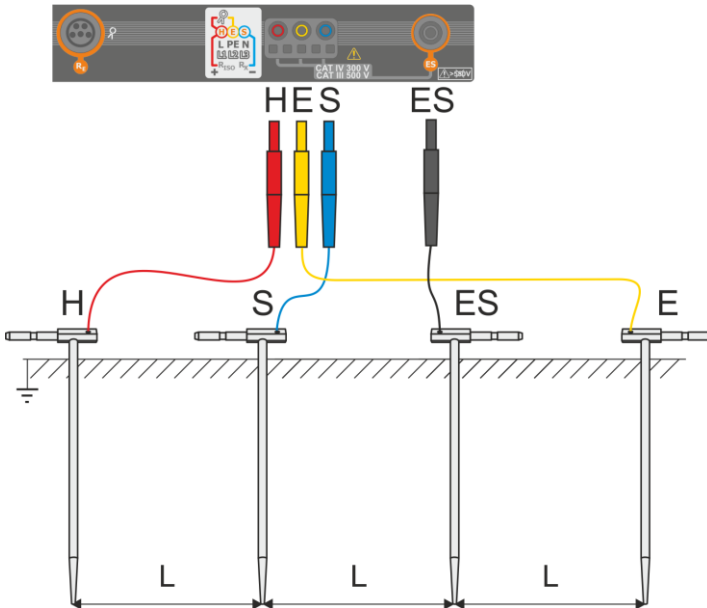

- Drive 4 probes into the ground **in one line** and at **equal** distances.
- Connect the probes to the meter according to the figure above.

2

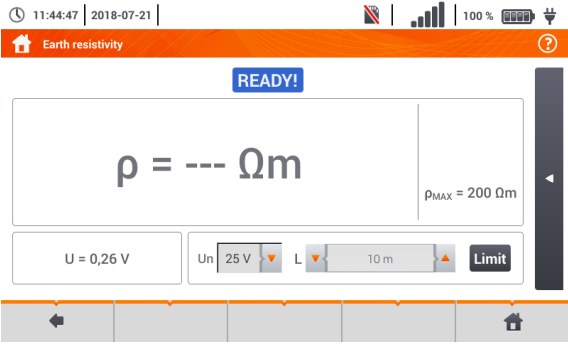

- Call up the measurement menu.
- Select other settings in accordance with **section 3.7.1**.



3



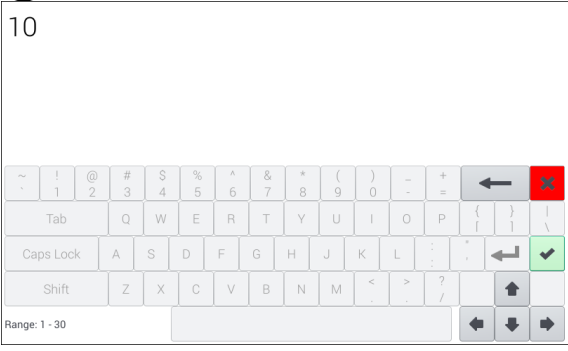

Select distance **L** between the measuring electrodes:

a



- a) using arrows  ,
- b) from the keyboard after touching the field with the distance value (range 1...30 m)

- Functions of icons**
-  reject changes and exit to the previous screen
  -  accept changes

4

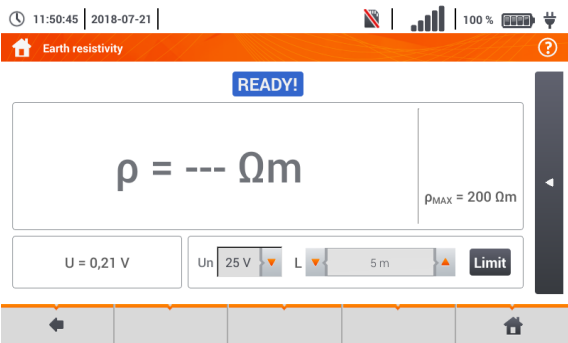

The meter is ready for measurement.

5



Press **START** to start the measurement.

6

11:51:55 | 2018-07-21 |



Read out the result.

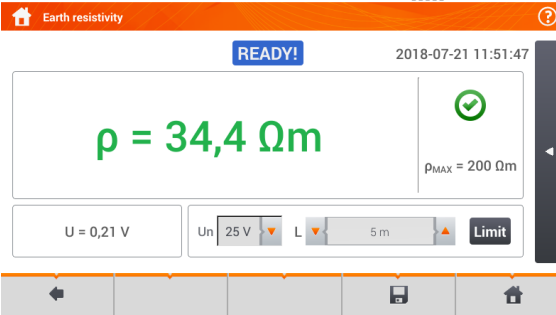

Signal lights for reaching the limit (section 3.7.1 step 4):

- the result is within the set limit
- the result is outside the set limit
- assessment not possible

After selecting the bar on the right side, a menu will slide out with additional measurement results.

7

11:52:07 | 2018-07-21 |



$R_H$  – resistance of current electrode

$R_S$  – resistance of voltage electrode

$\delta$  – additional uncertainty caused by resistance of the electrodes

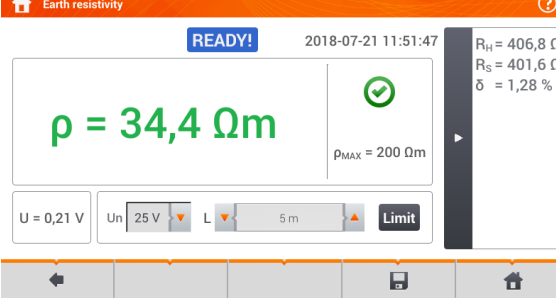

Selecting the bar hides the menu.

8

Save the measurement to the meter memory using the icon. A detailed description of memory management is contained in section 5.3.

The last measurement can be recalled using the icon.



### WARNING

- Measurement of resistivity may be carried out if voltage of interferences does not exceed 24 V. Voltage of interferences is measured up to the level of 100 V.
- Over 50 V it is signalled as hazardous. The meter must not be connected to voltages exceeding 100 V.



- The calculations assume that the distance between the measuring electrodes are equal (Wenner method). If it is not the case, perform the measurement of earth resistance using 4-pole method and calculate resistivity from the formula:

$$\rho = 2\pi LR_E$$

where:

L – distance between the electrodes

$R_E$  – measured resistance

- Particular attention should be paid to quality of connection between the object being tested and the test lead – the contact area must be free from paint, rust, etc.
- If **resistance of test probes is too high**, resistivity measurement **will include an additional uncertainty**. A particularly large measurement uncertainty arises when a small resistance value is measured with probes that have weak contact with the ground. Then, the ratio of resistance of the probes to measured resistance as a resistivity formula component is very high and consequently, uncertainty of measurement that depends on this ratio is also very high. Then, in accordance with the formulas from **section 10.4.4**, calculations can be made to estimate the influence of measurement conditions.
- To reduce the uncertainty of the  $\delta$ , measurement, the contact of the probe with earth may be improved, for example, by:
  - o moistening the spot where the probe is driven with water,
  - o driving the probe in a different location,
  - o applying an 80 cm probe.

Also, test the test leads for:

- o whether their insulation is not defective
- o whether the lead – banana plug – probe contact areas are not corroded or loosened.

In majority of cases the achieved measurement accuracy is satisfactory. However, you should always take account of the uncertainty included in the measurement.

## Additional information displayed by the meter

<b>READY!</b>	The meter is ready for measurement.
<b>IN PROGRESS</b>	Measurement in progress.
<b>VOLTAGE!</b>	Too high voltage at the meter terminals.
<b>H!</b>	Interruption in the test probe circuit.
<b>S!</b>	Interruption in the voltage probe circuit.
<b>RE&gt;1.99 kΩ</b>	Measuring range is exceeded.
<b>NOISE!</b>	Signal / noise ratio is too low (interfering signal too large).
<b>LIMIT!</b>	Error due to the resistance of electrodes > 30 % (for calculating uncertainty, measured values are taken into account).
	Interruption in measuring circuit or resistance of test probes is higher than 60 kΩ.

## 3.8 RCD parameters



The measurement of  $U_B$ ,  $R_E$  is always performed with sinusoidal current  $0.4 I_{\Delta n}$  regardless of the settings concerning waveform and multiplication factor  $I_{\Delta n}$ .

### 3.8.1 Settings of measurements

1



Select item **RCD  $I_A$**  or **RCD  $t_A$** .

2

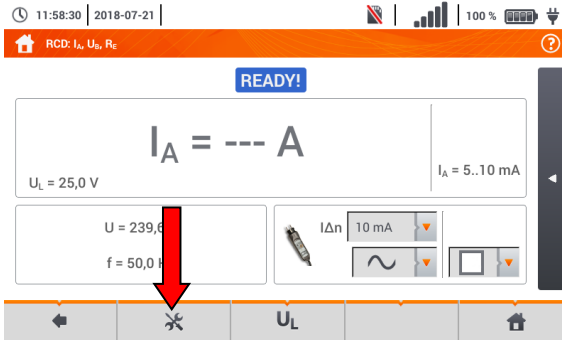

Define the displayed measurement components with the icon:

- a) if **RCD  $I_A$**  has been selected,
- b) if **RCD  $t_A$**  has been selected.

3a

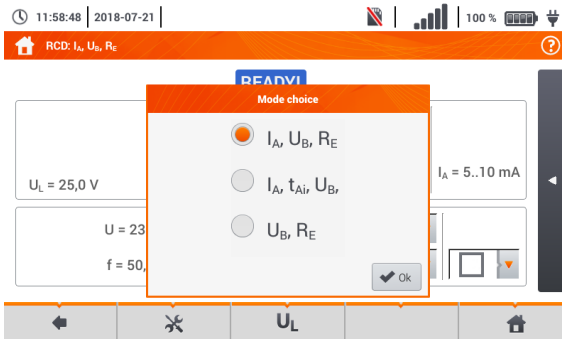

For **RCD  $I_A$**  the following parameters are available:  
 $I_A$  – RCD tripping current,  
 $U_B$  – voltage measured on PE,  
 $R_E$  – PE continuity,  
 $t_{AI}$  – RCD triggering time when measuring tripping current.

3b

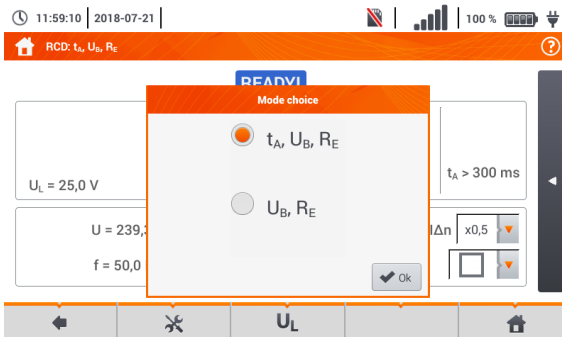

For **RCD  $t_A$**  the following parameters are available:  
 $U_B$  – voltage measured on PE,  
 $R_E$  – PE continuity,  
 $t_A$  – RCD triggering time when given the rated differential current ratio.

4

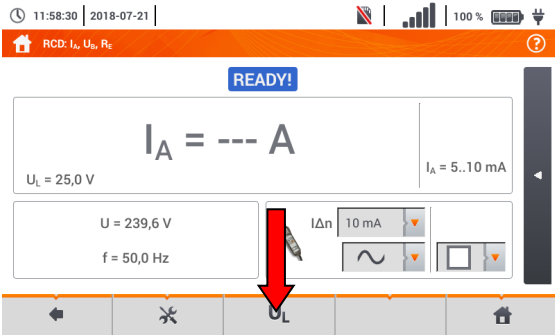

Select  $U_L$  to define the measuring voltage.

5

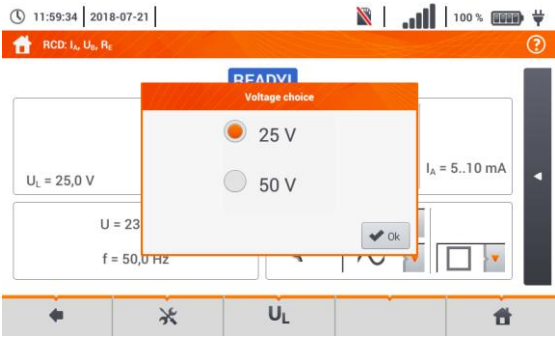

Select the required measuring voltage from the list.

6

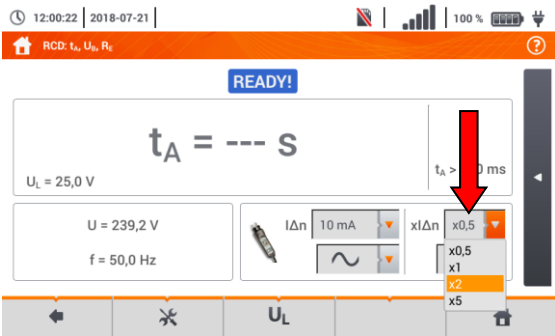

If the RCD  $t_A$  mode has been selected in step ①, set the forced current in the RCD test.

The set current is ratio of the rated residual current of the tested circuit breaker.

7

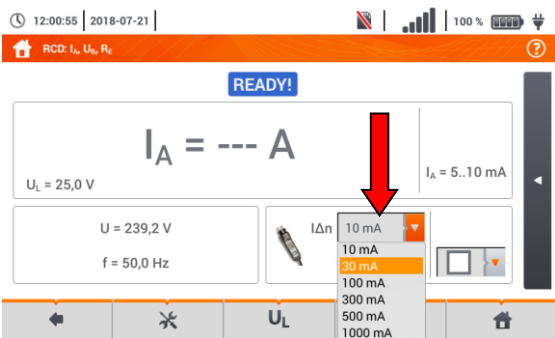

The correctness of the assessment of the test circuit breaker efficiency is dependent on the rated residual current.

Rated differential currents of RCDs are available in the menu.

- Touch the drop-down list field.
- Select the residual current of the test circuit breaker.

8

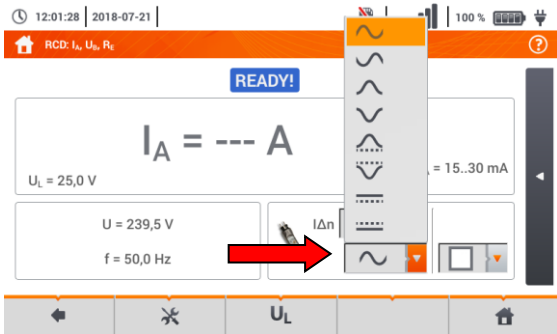

In the menu you can the waveform of the current, which will be used to test the RCD.

- Touch the drop-down list field. Select the waveform of the measuring current.

9

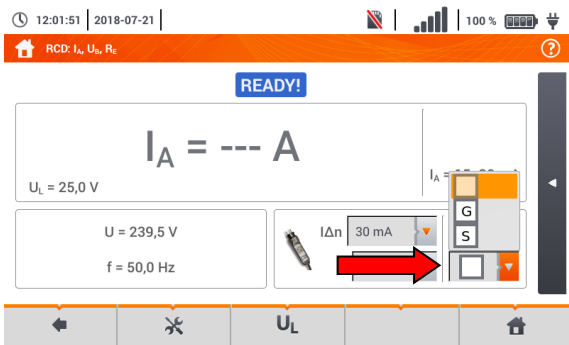

Determine the type of circuit breaker.

Available circuit breaker types

- general purpose
- G short-time delay type
- S selective

### 3.8.2 RCD tripping current

1 Connect the meter to the installation according to the drawing.

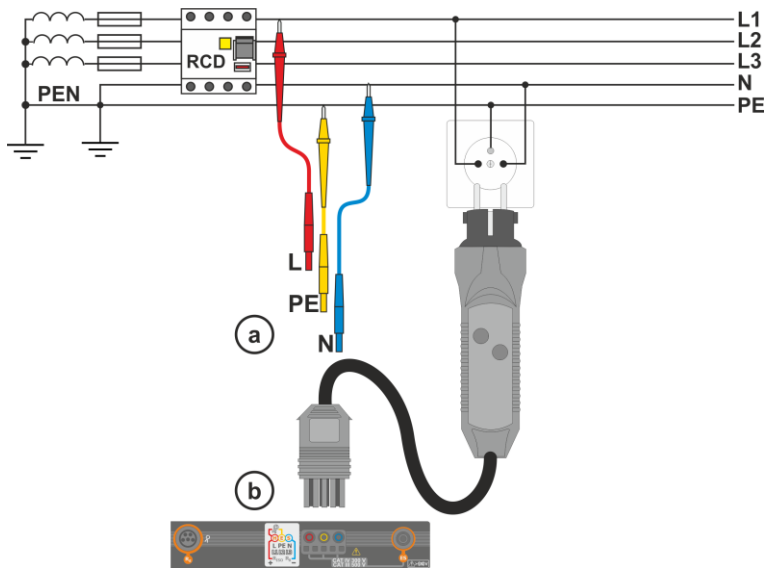

2



Select item **RCD I<sub>A</sub>**.

3 Enter the measurement settings in accordance with **section 3.8.1**.

4

12:01:12 | 2018-07-21 | 100%

RCD: I<sub>A</sub>, U<sub>L</sub>, R<sub>L</sub>

**READY!**

**I<sub>A</sub> = --- A**

U<sub>L</sub> = 25,0 V I<sub>A</sub> = 15..30 mA

U = 239,0 V IΔn 30 mA

f = 50,0 Hz

**U<sub>L</sub>**

**Live mode**  
**U** – voltage between phase conductor L and PE conductor  
**f** – network frequency in the tested circuit

5



Press **START** to start the measurement.

To cancel measurement, select the icon on the screen.

6

Read out the result.

### Measurement result assessment

green:

$$0.5 I_{\Delta n} < I_A \leq I_{\Delta n}$$

red:

$$I_A \leq 0.5 I_{\Delta n}$$

or

$$I_A > I_{\Delta n}$$

After selecting the bar  on the right side, a menu will slide out with additional measurement results.



7

Depending on the selection made in section 3.8.1 step (2) some of the parameters below will be displayed:

**U<sub>B</sub>** – voltage measured on PE,  
**R<sub>E</sub>** – PE continuity,  
**t<sub>A</sub>** – RCD triggering time with flow of RCD disconnecting current.

Selecting the  bar hides the menu.

8

Save the measurement to the meter memory using the  icon. A detailed description of memory management is contained in **section 5.3**. The last measurement can be recalled using the  icon.



- Measurement of the triggering time  $t_{Ai}$  ( $t_A$  measured during  $I_A$  measurement) for **selective RCDs** is not available.
- The measurement of triggering time  $t_{Ai}$  is **not performed as required** by applicable standards (i.e. **with RCD nominal current**  $I_{\Delta n}$ ), but **with  $I_A$  current** measured and displayed during the measurement. In most cases where the measurement does not have to be strictly as defined by the standard, this measurement may be taken into account to assess the proper operation of RCD protection in a particular installation. When measured  $I_A$  is lower than  $I_{\Delta n}$  (most frequent case), then triggering time  $t_{Ai}$  will be usually longer than the triggering time measured in function  $t_A$ , which measures the time at  $I_{\Delta n}$  current:

$$I_A < I_{\Delta n} \Rightarrow t_{Ai} > t_A$$

where:

$$t_{Ai} = f(I_{\Delta n})$$

Therefore, when time  $t_{Ai}$  is correct (not too long), it may be assumed that the time measured in function  $t_A$  would be also correct (it would not be longer).

## Additional information displayed by the meter

<b>IN PROGRESS</b>	Measurement in progress.
<b>U<sub>B</sub>&gt;U<sub>L</sub>!</b>	The touch voltage exceeds a preset U <sub>L</sub> threshold value.
<b>READY!</b>	The meter is ready for measurement.
<b>L-N!</b>	U <sub>L-N</sub> voltage is incorrect for making a measurement.
<b>L-PE!</b>	U <sub>L-PE</sub> voltage is incorrect for making a measurement.
<b>N-PE!</b>	U <sub>N-PE</sub> voltage is incorrect for making a measurement.
<b>L ↔ N</b>	Phase connected to N terminal instead of L terminal (for example, exchange of L and N in the mains socket).
<b>f!</b>	Network frequency is outside the range of 45...65 Hz.
<b>PE!</b>	PE conductor connected incorrectly.
<b>ERROR!</b>	Measurement error.
<b>U&gt;500V!</b>	Before measurement, voltage at test terminals exceeds 500 V.

### 3.8.3 RCD tripping time

1 Connect the meter to the installation according to the drawing.

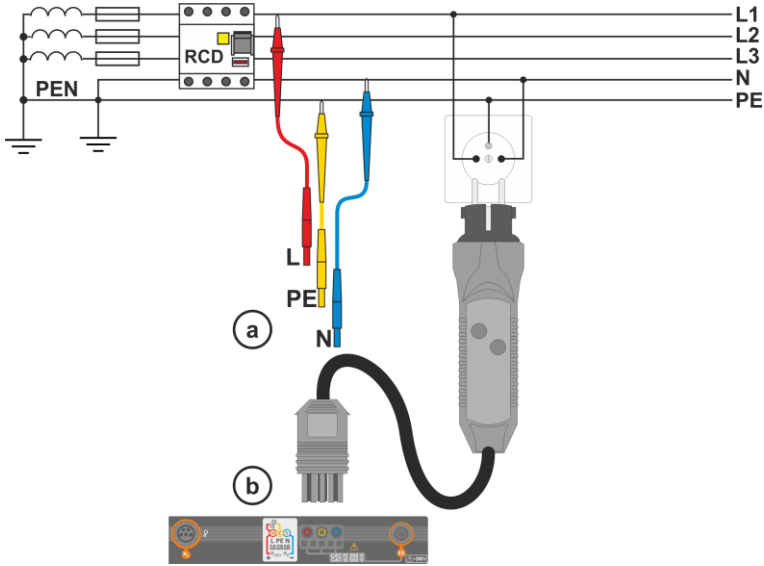

2



Select item **RCD t<sub>A</sub>**.

3

Enter the measurement settings in accordance with **section 3.8.1**.

4

12:16:47 | 2018-07-21 | 100% The meter is ready for measurement.

**READY!**

**t<sub>A</sub> = --- s** t<sub>A</sub> = 0..300 ms

U<sub>L</sub> = 25,0 V

U = 239,2 V  
f = 50,0 Hz

IΔn 30 mA xIΔn x1

**Live mode**  
**U** – voltage between phase conductor L and PE conductor  
**f** – network frequency in the tested circuit

5



Press **START** to start the measurement.

6

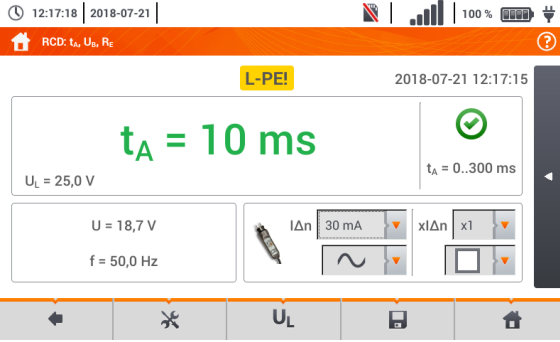

Read the result – RCD triggering time  $t_A$ .

Measurement result assessment

green:

$$t_A \leq t_{dop}$$

red:

$$t_A > t_{dop}$$

After selecting the bar  on the right side, a menu will slide out with additional measurement results.

7

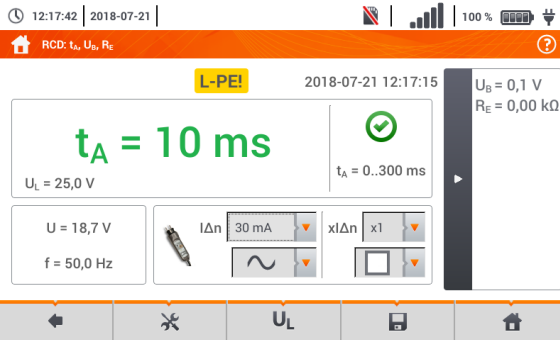



Depending on the selection made in section 3.8.1 step 2 some of the parameters below will be displayed:

$U_B$  – voltage measured on PE,  
 $R_E$  – PE continuity.

Selecting the  bar hides the menu.

8

Save the measurement to the meter memory using the  icon. A detailed description of memory management is contained in section 5.3. The last measurement can be recalled using the  icon.

## Additional information displayed by the meter

<b>IN PROGRESS</b>	Measurement in progress.
<b><math>U_B &gt; U_L!</math></b>	The touch voltage exceeds a preset $U_L$ threshold value.
<b>No <math>U_{L-N}!</math></b>	Lack of neutral lead that is necessary for $I_{\Delta N}$ constant and pulsed with direct current offset
<b>READY!</b>	The meter is ready for measurement.
<b>L-N!</b>	$U_{L-N}$ voltage is incorrect for making a measurement.
<b>L-PE!</b>	$U_{L-PE}$ voltage is incorrect for making a measurement.
<b>N-PE!</b>	$U_{N-PE}$ voltage is incorrect for making a measurement.
<b>L ↔ N</b>	Phase connected to N terminal instead of L terminal (for example, exchange of L and N in the mains socket).
<b>TEMPERATURE!</b>	Maximum temperature of the meter is exceeded.
<b>f!</b>	Network frequency is outside the range of 45...65 Hz.
<b>PE!</b>	PE conductor connected incorrectly.
<b>ERROR!</b>	Measurement error.
<b>U&gt;500V!</b>	Before measurement, voltage at test terminals exceeds 500 V.
<b>VOLTAGE!</b>	Voltage exceeded.

### 3.8.4 Measurements in IT networks

Before performing measurements select the appropriate network type in the main menu (menu **Measurement settings**, section 2.2.1).



#### NOTE!

After selecting an IT type network, the function of the **contact electrode** is **inactive**.

The manner of connecting the device to the installation is shown in **Fig. 3.8** and **Fig. 3.9**.

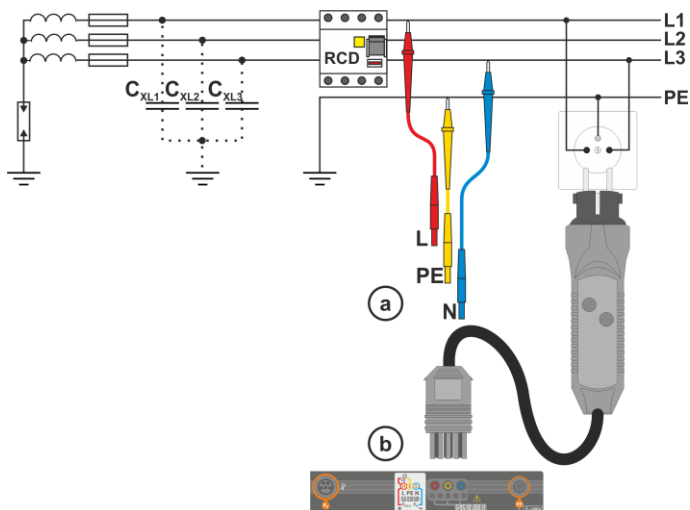

**Fig. 3.8 RCD measurement in the IT network. The circuit is closed by the parasitic capacitances  $C_x$**

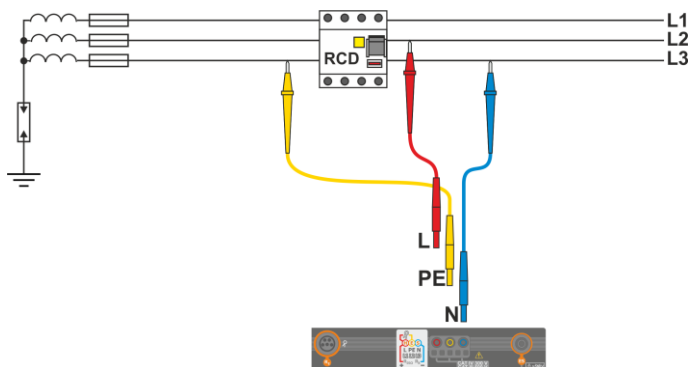

**Fig. 3.9 RCD testing without the PE conductor**

The manner in which the measurements of current and the RCD triggering time has been described in **section 3.8.2**, **3.8.3**.

Operating voltage range: **95 V ... 270 V**.

### 3.9 Automatic measurements of RCD parameters

The meter enables user to measure automatically RCD triggering time ( $t_A$ ), disconnection current ( $I_A$ ), contact voltage ( $U_B$ ) and resistance-to-earth ( $R_E$ ). In this mode, there is no need to trigger each measurement by pressing **START** button. The role of the user is reduced to initiating the measurement by single pressing **START** and switching RCD on after each tripping.

#### 3.9.1 Setting automatic measurements of RCD parameters

1



Select **RCD<sub>AUTO</sub>**.

2



• Select **U<sub>L</sub>** and from then select the required measuring voltage from the list.



IΔn

30 mA

• Select the rated differential current of tested protection.



• Select the type of tested protection.

3



• Select the parameters to be measured. Designations:

**I<sub>A</sub>** tripping current

**t<sub>A</sub>** response time

+ current with increasing head is forced

- current with decreasing head is forced

**x0.5 / 1 / 2 / 5** a multiplicity of RCD rated current, according to IEC 61557-6

• Select the metering mode:

**a** full,

**b** standard.

4a



If **full** mode has been selected, select the type of tested protection.



**RCD other than EV.** There is no 6 mA DC module in this type of device.



**EV type RCD.** Here there is a 6 mA DC module. In this situation, before the test it is necessary to:

• determine according to which standard the measurement is to be carried out (**sec. 2.2.1**),

• determine the multiplication factor of the 6 mA DC differential current (**EV** button). The test settings vary depending on the selected standard.

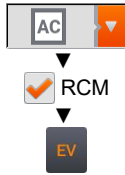

**RCD other than the EV, which is protected by a RCM** (residual current monitoring device at 6 mA DC). In this situation, before the test it is necessary to:

- determine according to which standard the measurement is to be carried out (**sec. 2.2.1**),
- tick **RCM**,
- determine the multiplication factor of the 6 mA DC differential current (**EV** button). The test settings vary depending on the selected standard.

4b



If **standard** mode has been selected, set the shape of the testing current. In this mode, RCD EV and RCM tests are unavailable.

### 3.9.2 Automatic measurement of RCDs

1 Connect the meter to the installation according to the drawing.

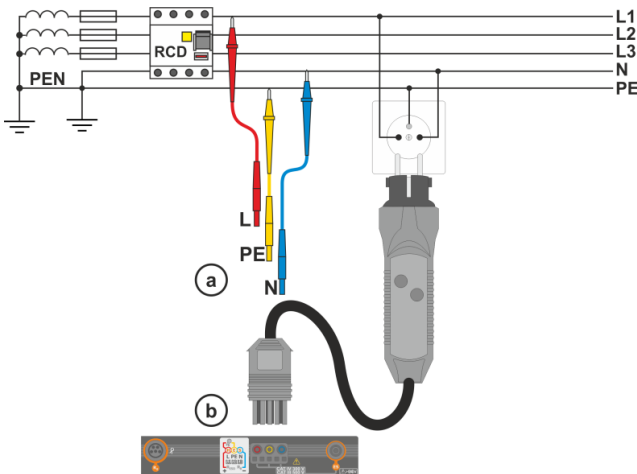

2



Select **RCD<sub>AUTO</sub>**.

3

Enter the measurement settings in accordance with **section 3.9.1**.

4

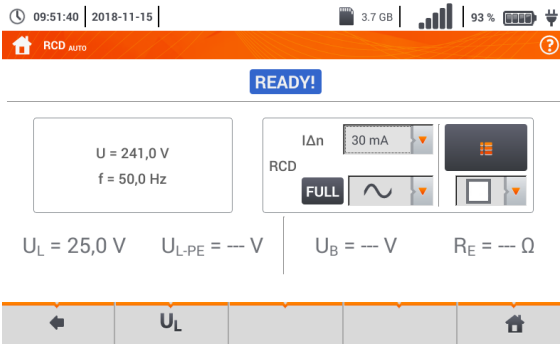

The meter is ready for measurement.

Live mode

**U** – voltage between phase conductor L and PE conductor  
**f** – network frequency in the tested circuit

5



Press **START** to start the measurement.

6

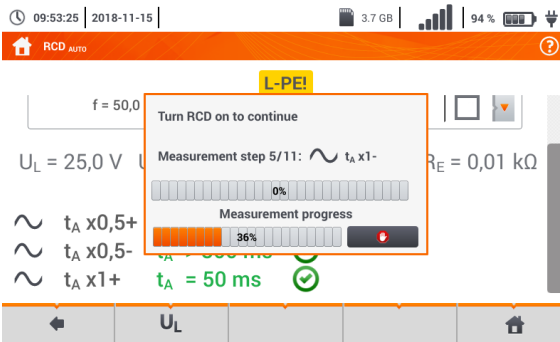

Tested RCD switch, must be **turned on** after each triggering, measurements are **completed**.

The progress of the measurement is illustrated by progress bars:  
**top** – progress of the ongoing measurement,  
**bottom** – progress of the entire measurement sequence.

The sequence may be cancelled at any time using icon .

7

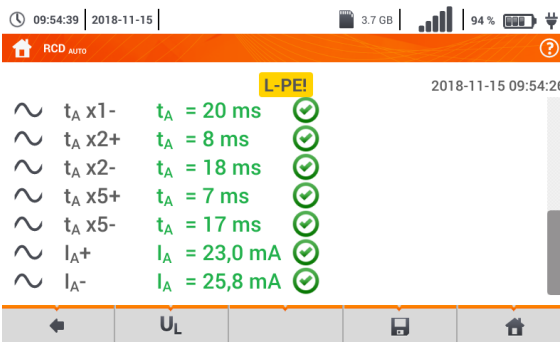



Eventually, measured parameters are displayed (**sec. 3.9.1 step 5**), and:

**U<sub>L</sub>** – test voltage,  
**U<sub>L-PE</sub>** – voltage between L and PE,  
**U<sub>B</sub>** – voltage measured on PE,  
**R<sub>E</sub>** – PE continuity.



The list of results may be scrolled on the screen.

Symbols indicating correctness of response

-  criterion met
-  criterion not met

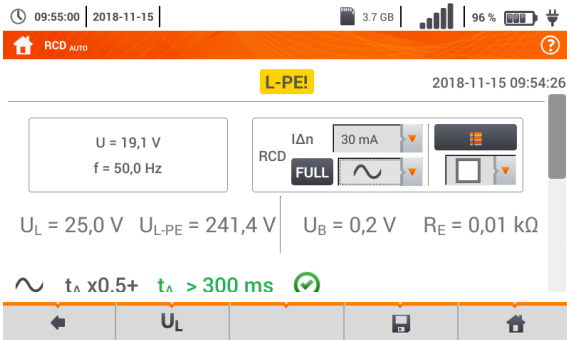
For more information refer to **Criteria for assessing the correctness of component results**.



- 8 Save the measurement to the meter memory using the  icon. A detailed description of memory management is contained in **section 5.3**. The last measurement can be recalled using the  icon.



- U<sub>B</sub> and R<sub>E</sub> are always measured.
- The measurement of U<sub>B</sub>, R<sub>E</sub> is always performed with sinusoidal current 0.4 I<sub>Δn</sub> regardless of the settings concerning waveform and multiplication factor I<sub>Δn</sub>.
- Automatic measurement is interrupted in the following cases:
  - the switch was tripped during the measurement of U<sub>B</sub>, R<sub>E</sub> or t<sub>A</sub> at the half value of I<sub>Δn</sub>,
  - the switch did not trip during other component measurements,
  - the value of pre-set voltage U<sub>L</sub> has been exceeded,
  - voltage was disconnected during one of the component measurements,
  - values R<sub>E</sub> and mains voltage did not allow to generate the required current value for one of component measurements.
- The meter automatically skips the measurements impossible to perform, e.g. when the value of selected current I<sub>Δn</sub> and its multiplicity exceed the testing range of the meter.

## Criteria for assessing the correctness of component results

Parameter	Assessment criterion	Notes
$I_A \sim$	$0.5 I_{\Delta n} \leq I_A \leq 1 I_{\Delta n}$	-
$I_A \sim \sim$ $I_A \sim \sim$	$0.35 I_{\Delta n} \leq I_A \leq 2 I_{\Delta n}$	for $I_{\Delta n} = 10 \text{ mA}$
$I_A \sim \sim$ $I_A \sim \sim$	$0.35 I_{\Delta n} \leq I_A \leq 1.4 I_{\Delta n}$	for other $I_{\Delta n}$
$I_A \dots$	$0.5 I_{\Delta n} \leq I_A \leq 2 I_{\Delta n}$	-
$I_A \dots 6 \text{ mA}$	$3 \text{ mA} \leq I_A \leq 6 \text{ mA}$	for 6 mA RCD <b>EV</b> and RCM (acc. to IEC 62955 and IEC 62752)
$t_A$ at $0.5 I_{\Delta n}$	$t_A \rightarrow \text{rcd}$	▪ for all types of RCD ▪ for AC module of RCD <b>EV</b>
$t_A$ at $1 I_{\Delta n}$	$t_A \leq 300 \text{ ms}$	▪ for general purpose RCDs <input type="checkbox"/> ▪ for AC module of RCD <b>EV</b>
$t_A$ at $2 I_{\Delta n}$	$t_A \leq 150 \text{ ms}$	▪ for general purpose RCDs <input type="checkbox"/> ▪ for AC module of RCD <b>EV</b>
$t_A$ at $5 I_{\Delta n}$	$t_A \leq 40 \text{ ms}$	▪ for general purpose RCDs <input type="checkbox"/> ▪ for AC module of RCD <b>EV</b>
$t_A$ at $1 I_{\Delta n}$	$130 \text{ ms} \leq t_A \leq 500 \text{ ms}$	for selective RCDs <b>S</b>
$t_A$ at $2 I_{\Delta n}$	$60 \text{ ms} \leq t_A \leq 200 \text{ ms}$	for selective RCDs <b>S</b>
$t_A$ at $5 I_{\Delta n}$	$50 \text{ ms} \leq t_A \leq 150 \text{ ms}$	for selective RCDs <b>S</b>
$t_A$ at $1 I_{\Delta n}$	$10 \text{ ms} \leq t_A \leq 300 \text{ ms}$	for short-time delay RCDs <b>G</b>
$t_A$ at $2 I_{\Delta n}$	$10 \text{ ms} \leq t_A \leq 150 \text{ ms}$	for short-time delay RCDs <b>G</b>
$t_A$ at $5 I_{\Delta n}$	$10 \text{ ms} \leq t_A \leq 40 \text{ ms}$	for short-time delay RCDs <b>G</b>
$t_A$ at $1 I_{\Delta n}$	$t_A \leq 10 \text{ s}$	for 6 mA RCD <b>EV</b> and RCM ( $I_{\Delta} = 6 \text{ mA}$ acc. to IEC 62955 and IEC 62752)
$t_A$ at $10 I_{\Delta n}$	$t_A \leq 300 \text{ ms}$	for 6 mA RCD <b>EV</b> and RCM ( $I_{\Delta} = 60 \text{ mA}$ acc. to IEC 62955 and IEC 62752)
$t_A$ at $33 I_{\Delta n}$	$t_A \leq 100 \text{ ms}$	for 6 mA RCD <b>EV</b> and RCM ( $I_{\Delta} = 200 \text{ mA}$ acc. to IEC 62955)
$t_A$ at $50 I_{\Delta n}$	$t_A \leq 40 \text{ ms}$	for 6 mA RCD <b>EV</b> and RCM ( $I_{\Delta} = 300 \text{ mA}$ acc. to IEC 62752)

## Additional information displayed by the meter

<b>IN PROGRESS</b>	Measurement in progress.
<b><math>U_B &gt; U_L!</math></b>	The touch voltage exceeds a preset $U_L$ threshold value.
<b>No <math>U_{L-N}!</math></b>	Lack of neutral lead that is necessary for $I_{\Delta n}$ constant and pulsed with direct current offset
<b>READY!</b>	The meter is ready for measurement.
<b>L-N!</b>	$U_{L-N}$ voltage is incorrect for making a measurement.
<b>L-PE!</b>	$U_{L-PE}$ voltage is incorrect for making a measurement.
<b>N-PE!</b>	$U_{N-PE}$ voltage is incorrect for making a measurement.
<b>L ↔ N</b>	Phase connected to N terminal instead of L terminal (for example, exchange of L and N in the mains socket).
<b>TEMPERATURE!</b>	Maximum temperature of the meter is exceeded.
<b>f!</b>	Network frequency is outside the range of 45...65 Hz.
<b>PE!</b>	PE conductor connected incorrectly.
<b>ERROR!</b>	Measurement error.
<b>U&gt;500V!</b>	Before measurement, voltage at test terminals exceeds 500 V.
<b>VOLTAGE!</b>	Voltage exceeded.

### 3.10 Insulation resistance



#### WARNING

The tested object must not be live.

#### 3.10.1 Settings of measurements

1



Select item **R<sub>ISO</sub>**.

2

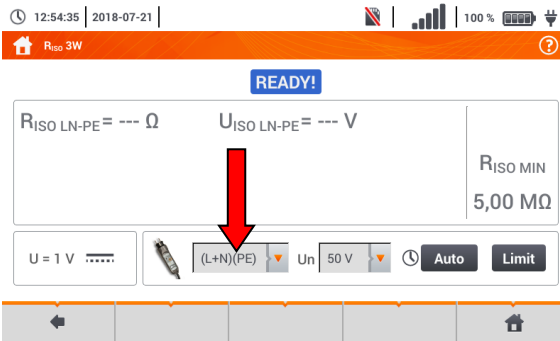

Connect the meter probe or the adapter which the measurements will be performed with.

Touch the drop down menu to set the measuring mode.

Positions will vary depending on whether the following have been connected to the meter:

- (a) probes,
- (b) UNI-Schuko adapter,
- (c) AutoISO-1000c adapter

3a

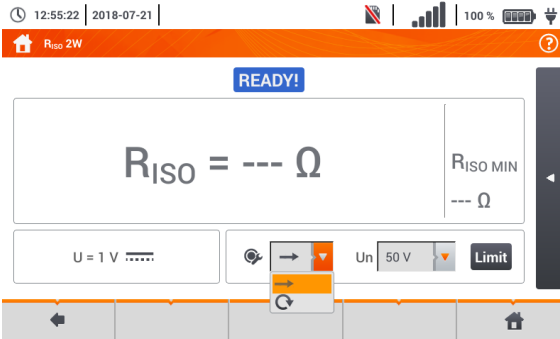

If **separate leads with probes** have been connected to the meter, select the required option from the menu:

- single measurement mode,
- ↻ continuous measurement mode.

3b

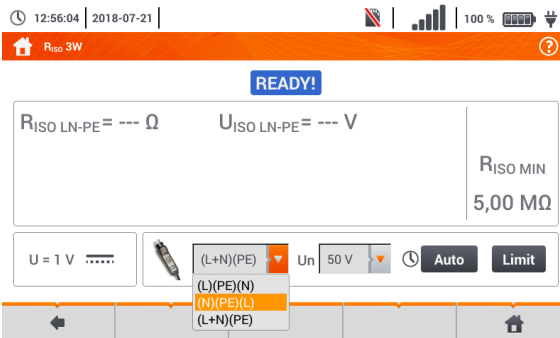

If **UNI-Schuko** adapter has been connected to the meter, select the required option from the menu:

- ⇒ **(L)(PE)(N)** – if the **phase** conductor on the **left** relative to the socket protective pin,
- ⇒ **(N)(PE)(L)** – if the **phase** conductor on the **right** relative to the socket protective pin,
- ⇒ **(L+N)(PE)** – shorted L and N conductors, measurement to PE (simplified method).

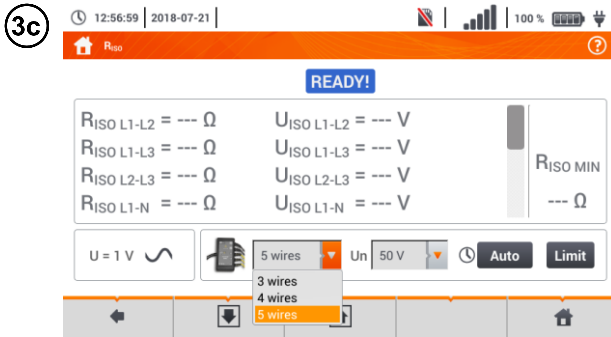

If **AutoISO** adapter has been connected to the meter, select the required option from the menu:

- ⇒ **3 wires** – measuring a 3-core cable,
- ⇒ **4 wires** – measuring a 4-core cable,
- ⇒ **5 wires** – measuring a 5-core cable.

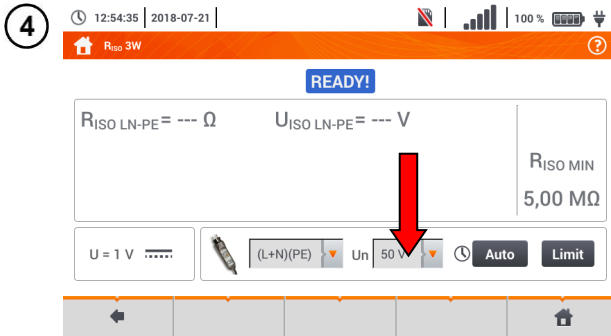

Touch the drop down menu to set the measuring voltage **Un**.

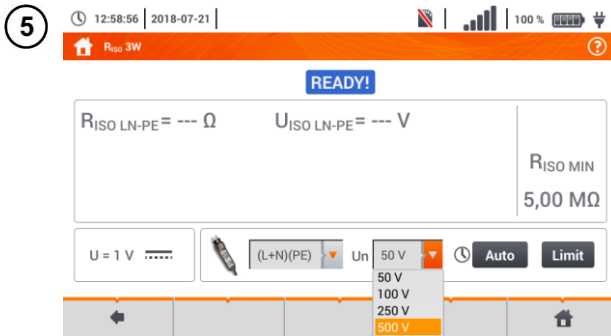

Select the required measuring voltage from the list.

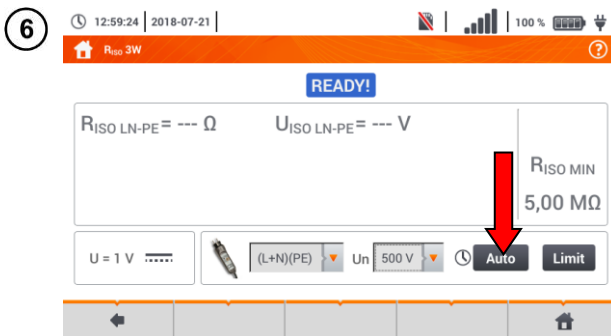

**Set the measurement duration** using the icon. After the selection has been made, it will display the set value.

7

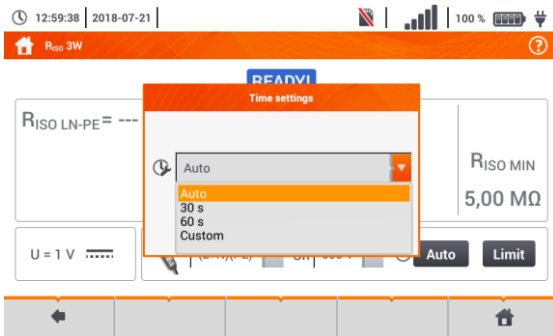

### Available options

- ⇒ **Auto** – the meter automatically selects measurement duration depending on the capacity of the object measured
- ⇒ 30 s
- ⇒ 60 s
- ⇒ **Custom** – manual setting of time within the range of 1...60 s

8

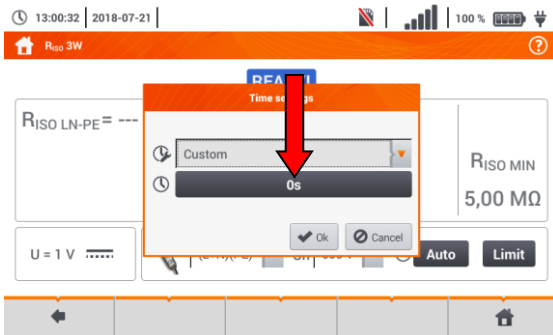

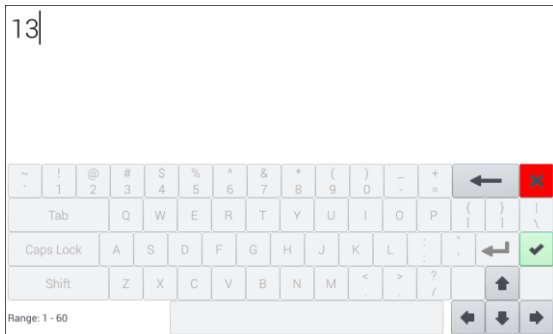

If the **Custom** option has been selected, enter the required time.

9



Delete the previous time value and enter a new one from the range of 1...60 s.

### Functions of icons

-  reject changes and exit to the previous screen
-  accept changes

10

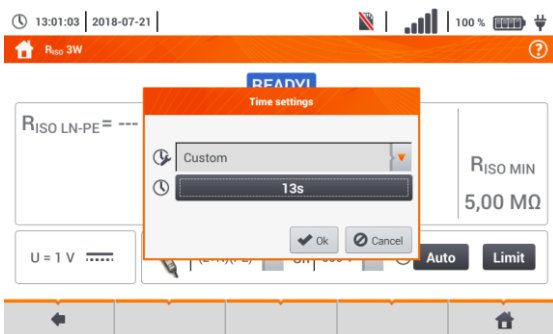

### Description of function icons

- Ok** – accept selection
- Cancel** – reject changes

11

Select **Limit** to set the acceptable insulation resistance criterion.



12



- Select unit.
- Delete the previous value and enter a new one. Ranges:
  - ⇒ **kΩ**: 0...2 000 000,
  - ⇒ **MΩ**: 0.0...2000.0,
  - ⇒ **GΩ**: 0.000...2.000.

Functions of icons

- rejecting changes and exit to the previous screen
- accepting changes

13

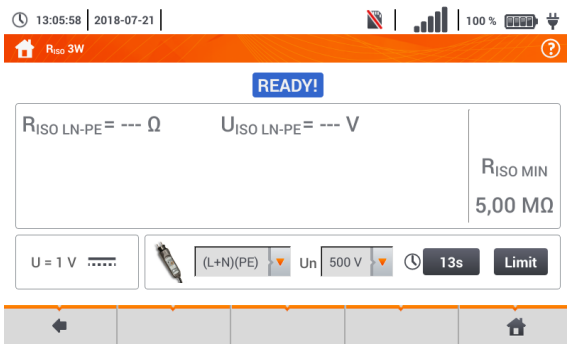

- returning to the previous screen
- going to the main menu

### 3.10.2 Measurement using probes



#### WARNING

- During measurements of insulation resistance, dangerous voltage up to 1 kV occurs at the ends of test leads of the meter.
- **It is forbidden** to disconnect test leads before the measurement is completed. Failure to obey the above instruction will lead to **electric shock with high voltage** and make it impossible to discharge the tested object.

①



Select item **R<sub>ISO</sub>** to call up the measurement menu.

②

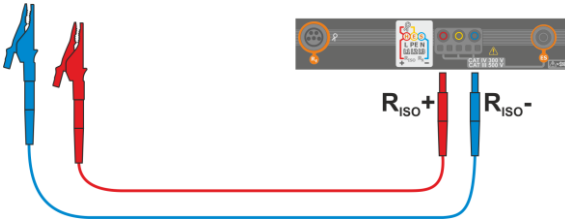

Connect the probes to the meter.

③

Enter the measurement settings in accordance with **section 3.10.1**

④

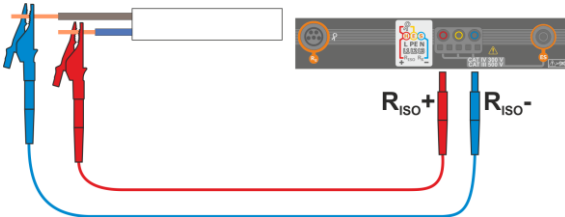

Connect test leads according to the drawing.

⑤



**Press and hold the START** button.

The measurement is performed continuously when the **START** is held in the pressed position.

In order to **interrupt** the measurement, press **START**.

If continuous measurement has been selected (icon ) , a **prompt** will appear to confirm the start of the measurement.



During the measurement the **H.V./REC/CONT.** diode is lit in **orange**.

6

13:16:03 | 2018-07-21 |



Read the measurement result.

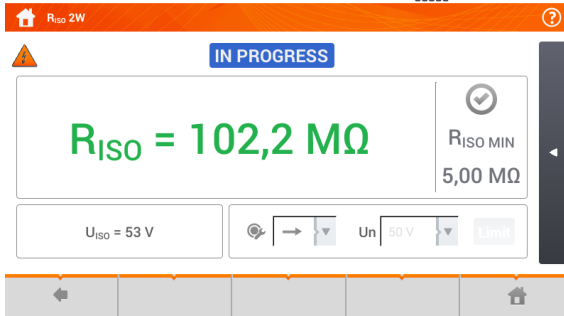

Signal lights for reaching the limit  
(**section 3.10.1 step (11)**)

- the result is within the set limit
- the result is outside the set limit
- assessment not possible

If continuous measurement has been selected (icon ), the measurement can be stopped by selecting the icon.



- The meter emits a continuous audio signal until test voltage reaches 90% of the preset value (and also when 110% of the preset value is exceeded).
- After completion of measurement, the capacitance of the object tested is discharged by shorting  $R_{ISO+}$  and  $R_{ISO-}$  terminals with resistance of 100 kΩ.

## Additional information displayed by the meter

<b>READY!</b>	The meter is ready for measurement.
<b>IN PROGRESS</b>	Measurement in progress.
	Too high voltage detected on terminals of the meter. Disconnects the terminals from the test object.
<b>NOISE!</b>	Interference voltage occurs on the tested object. Measurement is possible but may be burdened with additional uncertainty.
<b>LIMIT!</b>	Current limit tripped. The symbol displayed during the measurement is accompanied by a continuous beep. If it is displayed after the measurement, it means that the measurement result was obtained during operation with a current limiting device (e.g. short circuit on the test object).

### 3.10.3 Measurements using UNI-Schuko adapter (WS-03 and WS-04)



#### WARNING

- During measurements of insulation resistance, dangerous voltage up to 500 V occurs at the ends of test leads of the meter.
- **It is forbidden** to disconnect test leads before the measurement is completed. Failure to obey the above instruction will lead to **electric shock with high voltage** and make it impossible to discharge the tested object.

①



Select item **R<sub>iso</sub>**, to call up the measurement menu.

②

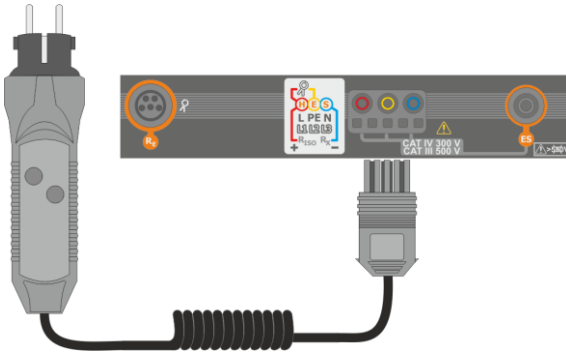

Connect **WS-03 adapter** or **WS-04 adapter** with UNI-Schuko outlet plug.

The meter detects this fact automatically and changes the appearance of the screen.

③

Enter the measurement settings in accordance with **section 3.10.1**

④

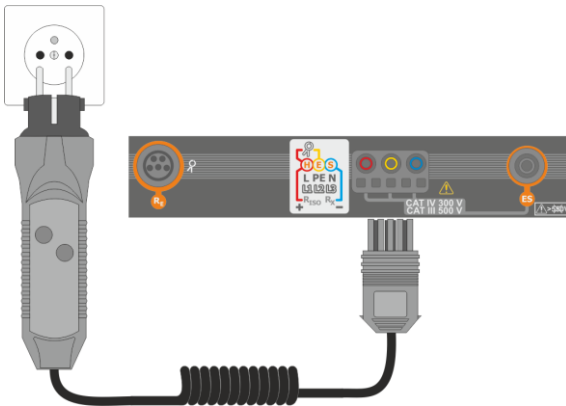

Connect the adapter to the test socket.

5



Press **START** to start measurement.

If any of the voltages exceeds allowable voltage value (50 V), **Object under voltage** message is displayed and the measurement is blocked.

During the measurement the **H.V./REC/CONT.** diode is lit in **orange**.

6

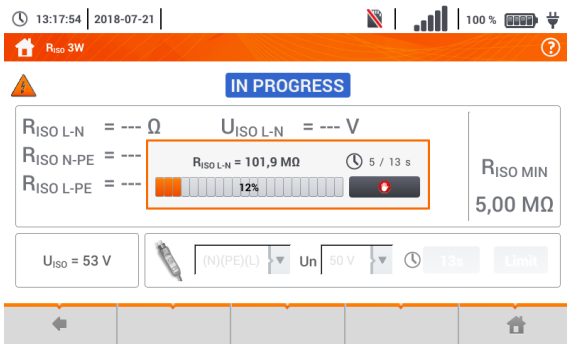

View of the screen during measurement.

The display shows the symbol of the resistance being measured and the progress bar of this measurement.

The progress bar indicates the status of the measurement.

The measurement may be cancelled at any time using the icon.

7

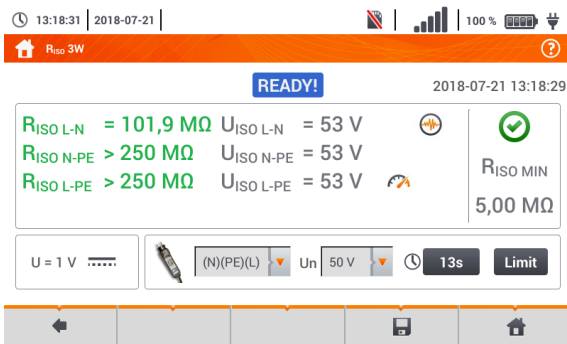

Read out the results.

Signal lights for reaching the limit (section 3.7.1 step (4))

- the result is within the set limit
- the result is outside the set limit
- assessment not possible

Additional signal lights for each of the measured lead pairs

- noise** – too strong interference signal recorded
- limit** – measurement taken at inverter current limit (e.g. short circuit in the test object)





8

Save the measurement to the meter memory using the icon. A detailed description of memory management is contained in **section 5.3**. The last measurement can be recalled using the icon.



- The meter emits a continuous audio signal until test voltage reaches 90% of the preset value (and also when 110% of the preset value is exceeded).
- After completion of measurement, the capacitance of the object tested is discharged by shorting  $R_{iso+}$  and  $R_{iso-}$  terminals with resistance of 100 k $\Omega$ .

## Additional information displayed by the meter

	The meter is ready for measurement.
	Measurement in progress.
	Too high voltage detected on terminals of the meter. Disconnects the terminals from the test object.
	Interference voltage occurs on the tested object. Measurement is possible but may be burdened with additional uncertainty.
	Current limit tripped. The symbol displayed during the measurement is accompanied by a continuous beep. If it is displayed after the measurement, it means that the measurement result was obtained during operation with a current limiting device (e.g. short circuit in the test object).