



USER MANUAL

EARTH RESISTANCE METER

MRU-21

MRU-21

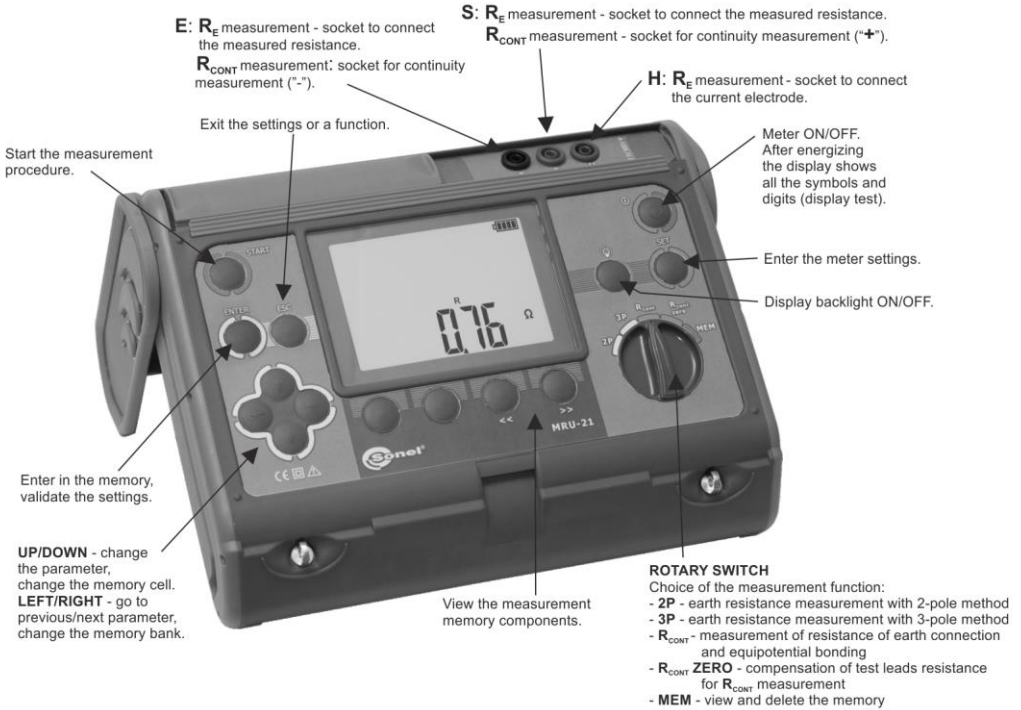

DISPLAY

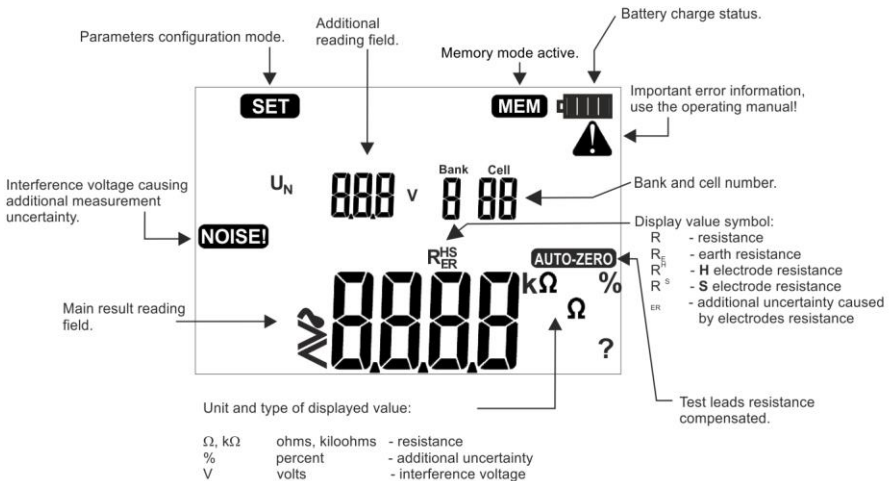



USER MANUAL

EARTH RESISTANCE METER MRU-21



**SONEL S.A.
Wokulskiego 11
58-100 Świdnica
Poland**

Version 1.07 10.03.2022

The MRU-21 meter is a modern, easy and safe measuring device. Please acquaint yourself with the present manual in order to avoid measuring errors and prevent possible problems related to operation of the meter.

CONTENTS

1	Safety	4
2	Settings	5
3	Measurements	6
3.1	Earth resistance measurement with 3-pole method (R_{E3P})	6
3.2	Earth resistance measurement with 2-pole method (R_{E2P})	10
3.3	Measurement of resistance of earth connection and equipotential bonding (R_{CONT})	12
3.4	Calibration of test leads	14
3.4.1	Turning AUTOZERO on	14
3.4.2	Turning AUTOZERO off	15
4	Memory	16
4.1	Storing the measurement result data in the memory	16
4.2	Viewing memory data	18
4.3	Deleting memory data	19
4.3.1	Deleting bank data	19
4.3.2	Deleting the whole memory	20
4.4	Communication with a computer	21
4.4.1	Computer connection accessories	21
4.4.2	Data transmission	21
5	Meter power supply	22
5.1	Monitoring of the power supply voltage	22
5.2	Replacement of batteries	22
6	Cleaning and maintenance	25
7	Storage	25
8	Dismantling and utilization	25
9	Technical specifications	26
9.1	Basic data	26
9.2	Additional information	28
9.2.1	R_E measurement	28
9.2.2	R_{CONT} measurement	29
10	Accessories	30
10.1	Standard accessories	30
10.2	Optional accessories	30
11	Manufacturer	31
12	Laboratory services	32

1 Safety

MRU-21 meter is designed for measuring parameters important for safety of electrical installations. Therefore in order to provide conditions for correct operation and the correctness of the obtained results, the following recommendations must be observed:

- Before you proceed to operate the meter, acquaint yourself thoroughly with this manual and observe the safety regulations and specifications defined by the producer.
- MRU-21 meter is designed to measure earth resistance and the resistance of protective conductors and equipotential bondings. Any application that differs from those specified in the present manual may result in a damage to the device and constitute a source of danger for the user.
- The meter must be operated solely by appropriately qualified personnel members holding required certificates for carrying measurements in electric installations. Unauthorized use of the meter may result in its damage and may seriously endanger unauthorized user.
- Using this manual does not exclude the need to comply with occupational health and safety regulations and with other relevant fire regulations required during the performance of a particular type of work. Before starting the work with the device in special environments, e.g. potentially fire-risk/explosive environment, it is necessary to consult it with the person responsible for health and safety.
- It is unacceptable to operate the following:
 - ⇒ a damaged meter which is completely or partially out of order,
 - ⇒ a meter with damaged test leads insulation,
 - ⇒ a meter stored for an excessive period of time in disadvantageous conditions (e.g. excessive humidity). **If the meter has been transferred from a cool to a warm environment of a high level of relative humidity, do not carry out measurements until the meter is warmed up to the ambient temperature (approximately 30 minutes).**
- Before commencing measurements, make sure the test leads are connected to the appropriate measurement sockets.
- Do not operate a meter with an open or incorrectly closed battery compartment or power it from sources other than those specified in this manual.
- The inputs of the meter are protected electronically against overload e.g. due to having been connected to a live circuit:
 - for all combinations of inputs - up to 276 V for 30 seconds.
- Repairs may be carried out only by an authorized service point.
- The device meets the requirements of standards EN 61010-1 and EN 61557-1, -4, -5.

Attention:

The manufacturer reserves the right to introduce changes in appearance, equipment and technical data of the meter.

2 Settings

Press the **SET** button to select the test voltage (Un) or power supply source (SuPP). After replacing the batteries, always set the power supply type. The correct charge indication depends on this setting (the discharge characteristics of disposable and rechargeable batteries are different).

1



Turn on the meter and press **SET**.

2

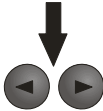

Use the ◀ and ▶ buttons to select the parameter: Un or SuPP.

3



Use the ▲ and ▼ buttons to change the parameters:
Un = 25 V or 50 V, SuPP = bAt (disposable batteries) or Acc (rechargeable batteries).



4



Press **ENTER** to validate the changes and exit the mode, or...



...press **ESC** to exit the setting mode without validating the changes.

3 Measurements

3.1 Earth resistance measurement with 3-pole method (R_{E3P})

The 3-pole measuring method is the basic type of resistance-to-earth measurement.

1

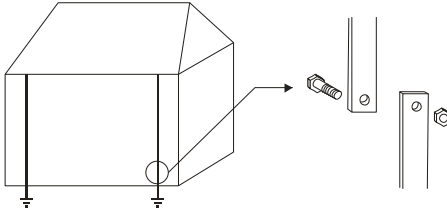

Disconnect the tested earth electrode from the installation of the facility.

2

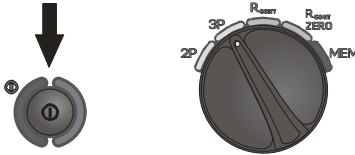

Turn on the meter.
Turn the rotary switch to the **R_{E3P}** position.

3

If necessary, adjust the voltage measurement according to section 2.

4

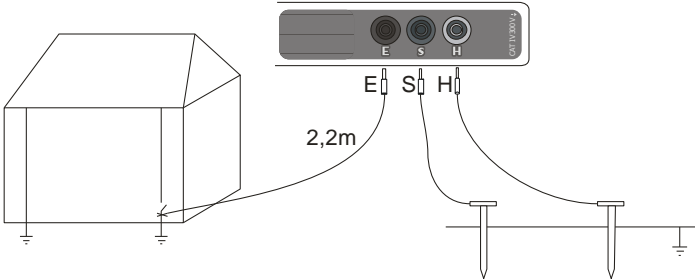

The current electrode (driven into earth) should be connected to **H** socket of the meter.
The voltage electrode (driven into earth) should be connected to **S** socket of the meter.
The tested earth electrode should be connected to **E** socket of the meter.
The tested earth electrode and the current electrode and the voltage electrode should be aligned.

5

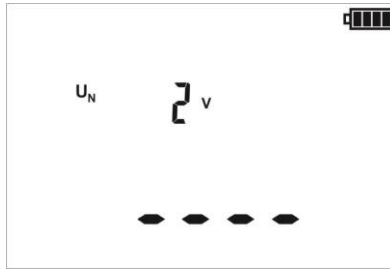

The meter is ready for measurement. Read the interference voltage on the auxiliary display.

6

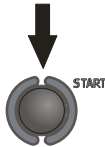

Press **START**.
Perform the measurement.

7

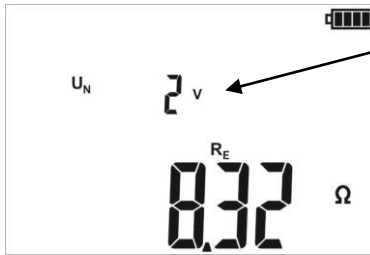

Interference voltage.

Read the main measurement result.

Resistance of earth electrode R_E .

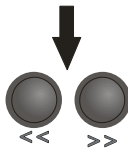

Read the auxiliary results (sequence as below) by pressing << and >>.

8



R_H

Resistance of current electrode

9



R_S

Resistance of voltage electrode

10



Additional uncertainty caused by resistance of the auxiliary electrodes.

11

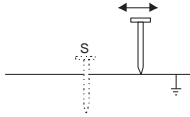

Repeat the measurements (steps 3-6) after moving the voltage a few meters - placing it farther and closer to the measured earth electrode. If the R_E measurement results differ by more than 3%, the distance of the current electrode from the tested earth electrode should be considerably increased and the measurements should be repeated.

Note:













The earth resistance measurement can be made when the interference voltage does not exceed 24 V. The voltage is measured up to 100 V, but above 50 V is indicated as dangerous. The meter must not be connected to voltages exceeding 100 V.

- Particular attention should be paid to quality of connection between the tested facility and the test lead – the contact area must be free from paint, rust, etc.

- If resistance of the auxiliary electrodes is too high, R_E earth electrode measurement will include an additional uncertainty. Particularly high measurement uncertainty occurs when a small value of resistance to earth is measured with electrodes that have a weak contact with earth (such a situation occurs frequently when the earth electrode is well made and the upper soil layer is dry and poorly conductive). In such a case, the ratio of resistance of the electrodes to resistance of the tested earth electrode is very high and consequently, uncertainty of measurement that depends on this ratio is also very high. Then, you can make a calculation according to the formulas given in item 9 to estimate the influence of measurement conditions, or you can use the graph also included in the appendix. This uncertainty is also displayed in [%] as an additional result. It is calculated on the basis of measured valued. If such additional uncertainty exceeds 30% the **Err** symbol is displayed. You can improve the contact between the probe and soil, for example by dampening with water the place where the electrode is driven into earth, driving the electrode into earth in a different place, or using a 80 cm-long electrode. Check also the test leads for possible insulation damage and for corroded or loosened connection between the banana plug and the test lead. In majority of cases the measurement accuracy achieved is satisfactory. However, one should always be aware of the uncertainty included in the measurement.

- Factory calibration includes the resistance of the 2.2 m test lead (supplied).

Additional information displayed by the meter

u_s 30 v > 24 v and 	Excessive interference voltage (> 24 V). The measurement is not possible. Disconnect the source of interference or try another location of the auxiliary electrodes.
u_s 70 v > 50 v and  and continuous audio signal 	Interference voltage exceeds 50 V! Disconnect the meter immediately! Disconnect the voltage source before you reconnect the meter.
u_{DFL} > 50 v and  and continuous audio signal 	Interference voltage exceeds 100 V! Disconnect the meter immediately! Disconnect the voltage source before you reconnect the meter.
r with the electrode (electrodes) name and 	Interruption in measuring circuit or resistance of auxiliary electrodes higher than 60 k Ω . Check connections in the test circuit or reduce the auxiliary electrode resistance by driving it into the soil again.
E_r (in the field below Cell) and measurement result and 	Uncertainty of the R_E measurement caused by electrodes resistance exceeds 30%. Reduce the electrode resistance by driving it into the soil again or by dampening the soil in its immediate vicinity.
>1,99k Ω	The R_E measuring range is exceeded.
>50k Ω	Test auxiliary electrodes resistance above 50 k Ω (but below 60 k Ω).
NOISE!	Interference voltage above 10 V, or unstable measurement result, or the measured voltages or currents are too low in relation to the noise.
no 5 and  and long audio signal 	Measured voltages or currents are too low in relation to the noise, or highly unstable measurement result. (The no 5 symbol is displayed instead of the result).
mT and 	Maximum allowed temperature inside the meter is exceeded.

3.2 Earth resistance measurement with 2-pole method (R_{E2P})

1

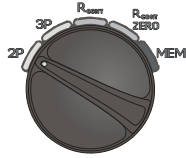

Turn on the meter.
Turn the rotary switch to the R_{E2P} position.

2

If necessary, adjust the voltage measurement according to section 2.

3

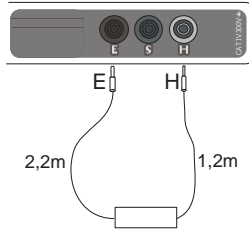

Connect the tested facility to the **E** and **H** terminals.

4

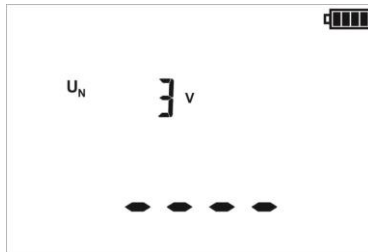

The meter is ready for measurement.
Read the interference voltage on the auxiliary display.

5

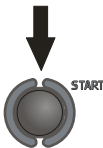

Press **START**.
Perform the measurement.

6

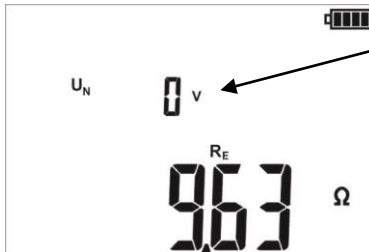

Interference voltage.











Read the measurement result.

Measured resistance.

Note:

- Factory calibration includes the resistance of the 1.2 m and 2.2 m test leads (supplied).

Additional information displayed by the meter

u_x 30 V > 24 V and 	Excessive interference voltage (> 24 V). The measurement is not possible. Disconnect the source of interference.
u_x 70 V > 50 V and  and continuous audio signal 	Interference voltage exceeds 50 V! Disconnect the meter immediately! Disconnect the voltage source before you reconnect the meter.
u_{DFL} > 50 V and  and continuous audio signal 	Interference voltage exceeds 100 V! Disconnect the meter immediately! (The DFL symbol is displayed instead of the interference voltage). Disconnect the voltage source before you reconnect the meter.
 and 	Interruption in the test circuit.
R_E > 1,99 k Ω	The R_E measuring range is exceeded.
NOISE!	Interference voltage above 10 V, or unstable measurement result, or the measured voltages or currents are too low in relation to the noise.
no 5 and  and long audio signal 	Measured voltages or currents are too low in relation to the noise, or highly unstable measurement result. (The no 5 symbol is displayed instead of the result).
TC and 	Maximum allowed temperature inside the meter is exceeded.

3.3 Measurement of resistance of earth connection and equipotential bonding (R_{CONT})

NOTE

Calibrate the test leads when measuring very small resistance values or when using test leads different than the supplied 1.2 m and 2.2 m.

1

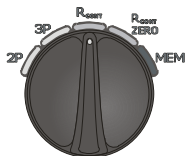
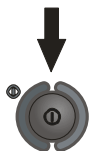

Turn on the meter.
Turn the rotary switch to the R_{CONT} position.

2

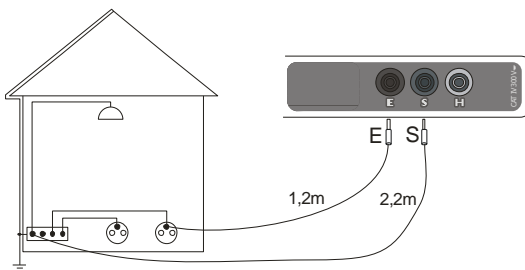

Connect the tested facility to the **S** and **E** terminals.

3

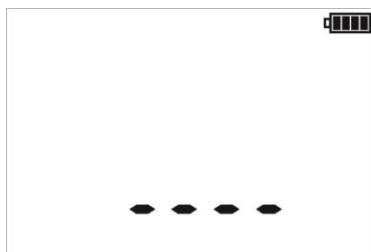

The meter is ready for measurement.

4

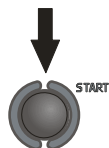

Press **START**.
Perform the measurement.

5

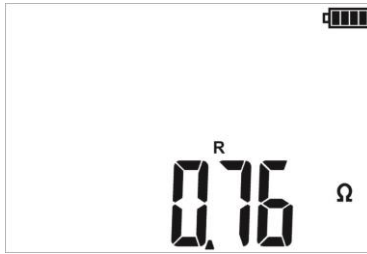







Read the measurement result.

Note:

- The test current flows in one direction. To obtain the result for both directions, switch the test leads and perform the measurement again, then calculate the arithmetic mean of both results.

Additional information displayed by the meter

$> 3^v$ and 	Excessive interference voltage (> 3 V RMS). The measurement is not possible. Disconnect the source of interference.
$> 50^v$ and  and continuous audio signal 	Interference voltage exceeds 50 V! Disconnect the meter immediately! Disconnect the voltage source before you reconnect the meter.
$> 199\Omega$	The R_{CONT} measuring range is exceeded.
NOISE!	1...3 V RMS interference voltage during the R_{CONT} measurement. Measurement is slightly unstable. The results may include an additional uncertainty.
no, 5 and  long audio signal 	Measurement is highly unstable.
 and 	Maximum allowed temperature inside the meter is exceeded.

3.4 Calibration of test leads

In order to eliminate the impact of the resistance of test leads on the measurement result, the compensation (autozeroing) of resistance may be performed. This is made with the **AUTOZERO** function in the Rcont measurement.

3.4.1 Turning AUTOZERO on

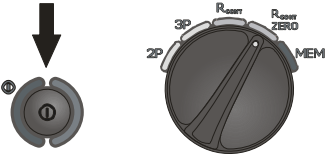
1  Turn on the meter.
Turn the rotary switch to the **R_{CONT} ZERO** position.

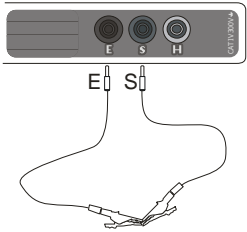
2  Short the test leads by putting crocodile clips on exposed ends of the test leads.

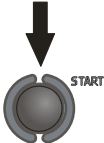
3  Press **START**.
Perform autozeroing.

4  Autozeroing completed.

Note:

- Remember that the resistance of crocodile clips and crocodile-banana connections is added to the resistance of the test leads.

3.4.2 Turning AUTOZERO off

①

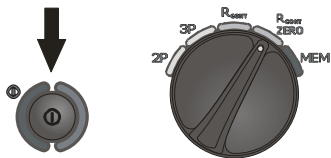

Turn on the meter.
Turn the rotary switch
to the the **RCONT ZERO**
position.

②

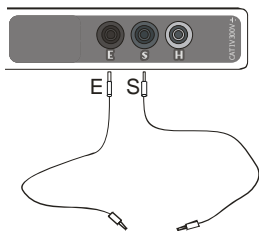

Disconnect the test
leads.

③

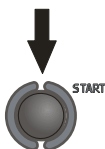

Press **START**.

④



Autozeroing is off.
During the
measurements, the
meter will compensate
the resistance of the
supplied 1.2 m and
2.2 m leads.

NOTE

It suffices when the compensation for given test leads is performed only once.
It is remembered when the meter is turned off.

4 Memory

The MRU-21 meters feature memory that can store 990 single measurement results. The whole memory is divided into 10 memory banks, with 99 cells in each bank. Each measurement result can be stored in a memory cell marked with a selected number and in a selected memory bank. Thanks to this, the user of the meter can, at his/her option, assign memory cell numbers to individual measurement points and the memory bank numbers to individual facilities. The user can also perform measurements in any sequence and repeat them without losing other data.

Memory of measurement result data **is not deleted** when the meter is switched off. Thanks to this, the data can be later read or sent to a computer. The number of a current memory cell or memory bank is not changed either.

Note:

- One cell can contain the results of a single measurement.
- After each entry of the measurement result to the cell, its number is automatically incremented.
- It is recommended to delete the memory after reading the data or before performing a new series of measurements that may be stored into the same memory cells as the previous ones.

4.1 Storing the measurement result data in the memory

①



Press **ENTER** after completion of the measurement.
The meter is in the memory storing mode.

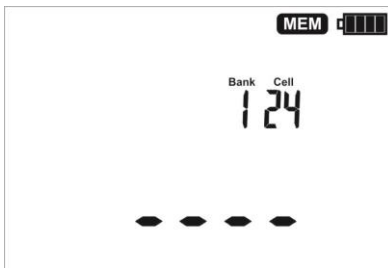

Cell is empty.

②

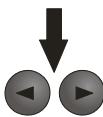

Use the ◀ and ▶ symbols to select the bank...



or use the ▲ and ▼ symbols to select the cell.

3



Press **ENTER** again. The screen (shown below) appears for a moment, accompanied by three short beeps, and then the meter returns to display the last result of the measurement.

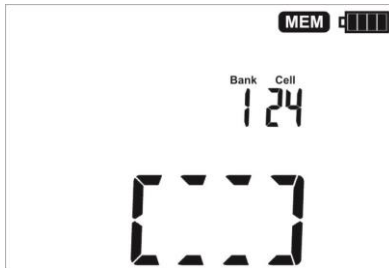

4

An attempt to overwrite a result causes the warning symbol to appear.

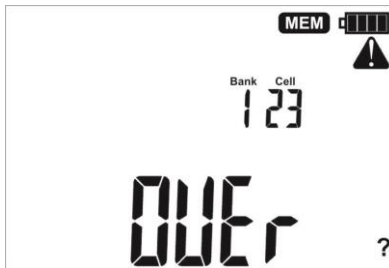

5

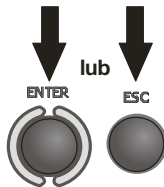

Press **ENTER** to overwrite the result or **ESC** to abort.

Note:

- Stored in the memory is a complete set of results (main result and supplementary results), as well as the test voltage for R_E .

4.2 Viewing memory data

1

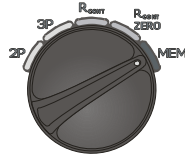

Turn on the meter.
Turn the rotary switch to the **MEM** position.

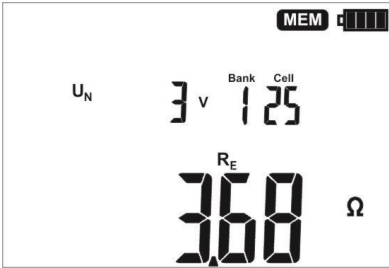

The content of the last saved cell appears.

2

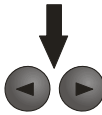

Use the ◀ and ▶ symbols to select the bank...



or use the ▲ and ▼ symbols to select the cell.

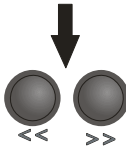

Press << or >> to view additional results.

4.3 Deleting memory data

4.3.1 Deleting bank data

①

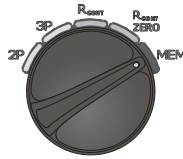

Turn on the meter.
Turn the rotary switch to the the **MEM** position.

②

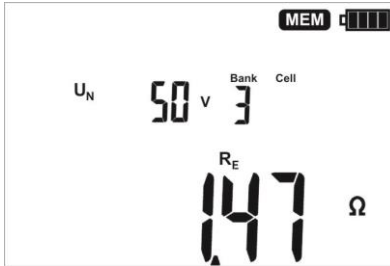

Set the bank number to be deleted.
Set the cell number before "1"...

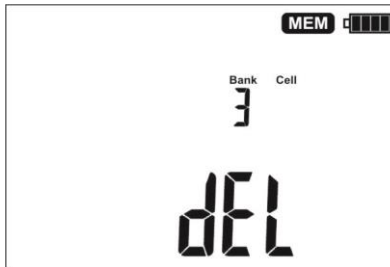

...the cell number disappears, and appears the symbol **DEL** indicating the readiness to delete.

③



Press **ENTER** .



The "?" and  symbols appear, asking you to confirm deletion.

4

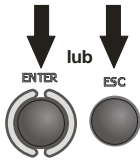

Press **ENTER** to start deleting or **ESC** to abort.

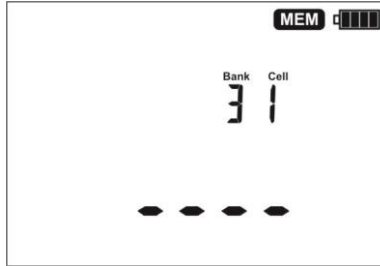

The deletion progress is shown on the display as dashes (each dash means 25%). When deletion is complete, the meter generates three short beeps and sets the cell number to "1".

4.3.2 Deleting the whole memory

1

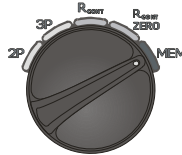

Turn on the meter.
Turn the rotary switch to the **MEM** position.

2

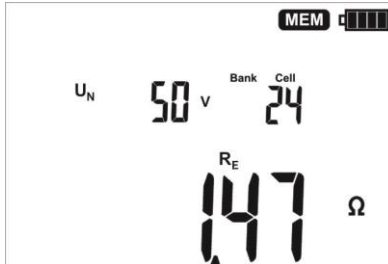

Set the bank number between "0" and "9"...





...the bank number disappears, and appears the symbol **del**, indicating the readiness to delete.

3

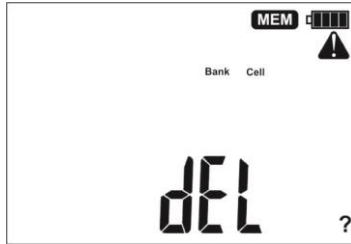

Press **ENTER** .



The "?" and  symbols appear, asking you to confirm deletion.

4

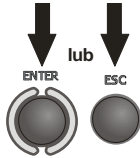

Press **ENTER** to start deleting or **ESC** to abort.

The deletion progress is shown on the display as dashes (each dash means 25%).

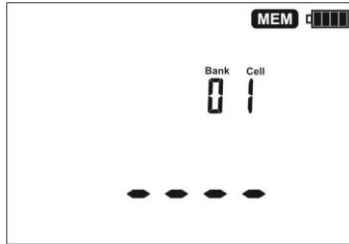

When deletion is complete, the meter generates three short beeps and sets the bank number to "0" and the cell number to "1".

4.4 Communication with a computer

4.4.1 Computer connection accessories

What is necessary in order to operate the meter with a computer is additional accessories, namely a cable for serial transmission and appropriate software. If this package has not been purchased along with the meter, it can be bought from the manufacturer or an authorized distributor where detailed software information is also available.

4.4.2 Data transmission

If the rotary switch is in the **MEM** position, after detecting the USB connection with a computer the meter automatically goes to the data transmission mode and displays the following screen.



To transmit data, follow the instructions of the software.

5 Meter power supply

5.1 Monitoring of the power supply voltage

The charge level of the batteries or rechargeable batteries is indicated by the symbol in the right upper corner of the display on a current basis:

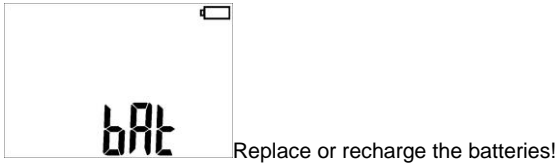
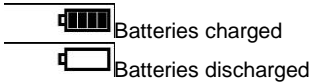

Note:

- The **bat** symbol on the display means insufficient power supply voltage and the need to replace or recharge the batteries.
- Measurements performed with an insufficient supply voltage feature additional errors which the user is unable to evaluate. Consequently, such measurements cannot prove that the tested earthing system is correct.

5.2 Replacement of batteries

The MRU-21 is powered by four R14 disposable or rechargeable batteries (alkaline batteries are recommended). The disposable or rechargeable batteries are placed in the compartment at the bottom of the enclosure.

WARNING:
Before replacing the batteries, disconnect the test leads from the meter.

To replace the batteries:

- remove all test leads from the sockets and turn the meter off,
- remove the four screws of the battery compartment (in the lower part of the enclosure),
- remove the compartment and take off the lid (use a tool),
- remove and replace all batteries, observing the correct polarity when putting new batteries ("-" on the spring). Reverse polarity will not damage the meter or the batteries, but the meter will not work.
- put on the lid, place the compartment and secure it with 4 screws.

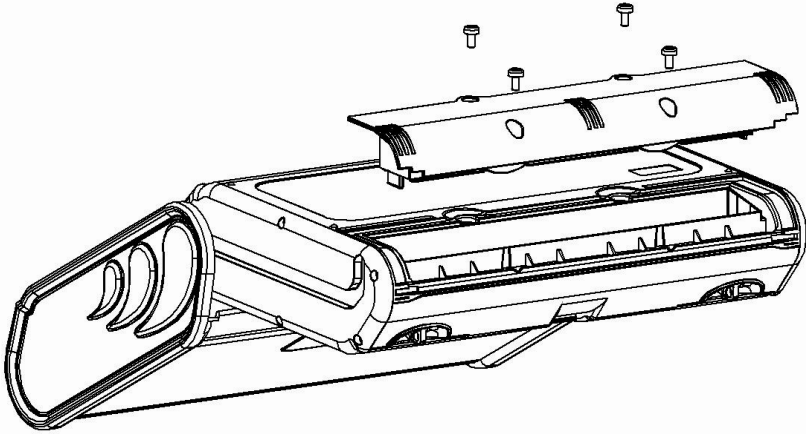

After replacement of batteries, the meter when turned on, starts in the power supply selection mode.



Selected power supply:
rechargeable batteries:



Use the ▲ and ▼ symbols to select the power supply: bAt (disposable batteries) or Acc (rechargeable batteries).



Press **ENTER** to validate the choice
The meter goes to the measurement readiness mode.

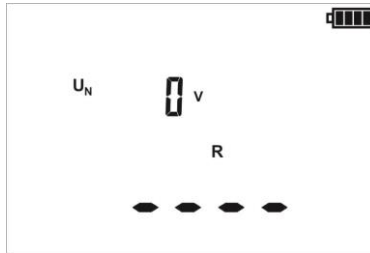

NOTE!

After replacing the batteries, always set the power supply type. The correct charge indication depends on this setting (the discharge characteristics of disposable and rechargeable batteries are different).

NOTE!

Have the meter serviced in case of battery leakage inside the compartment.

Batteries must be recharged in an external charger.

6 Cleaning and maintenance

NOTE!

Apply only maintenance methods specified by the manufacturer in this manual.

The casing of the meter and its case may be cleaned with a soft, damp cloth using all-purpose detergents. Do not use any solvents or cleaning agents which might scratch the casing (powders, pastes, etc.).

Clean the auxiliary electrodes with water and dry it. Before the auxiliary electrodes are stored for a prolonged period of time it is recommended to grease them with any machine lubricant.

The reels and test leads should be cleaned with water and detergents, and then dried.

The electronic system of the meter does not require maintenance.

7 Storage

The following recommendations must be observed to ensure proper storing of the device:

- Disconnect all the test leads from the meter.
- Clean the meter and all its accessories thoroughly.
- Wind the long test leads onto the reels.
- If the meter is to be stored for a prolonged period of time, the batteries must be removed from the device.
- in order to prevent total discharge of the rechargeable batteries during prolonged storage, charge them from time to time.

8 Dismantling and utilization

Worn-out electric and electronic equipment should be collected selectively, i.e. it must not be disposed with waste of another kind.

Worn-out electronic equipment should be sent to a collection point in accordance with regulations related to Waste Electrical and Electronic Equipment.

Before the equipment is sent to a collection point, do not attempt to dismantle any elements.

Observe the local regulations concerning disposal of packages, worn-out batteries and accumulators.

9 Technical specifications

- The specified accuracy relates to the meter terminals.
- "m.v." means a standard measured value.

9.1 Basic data

Measurement of earth resistance – 3-pole method (R_E3P)

Measurement method: 3-pole, conforming with IEC 61557-5.

Measuring range acc. to IEC 61557-5: 0.50 Ω ... 1.99 kΩ for U_n=50 V

0.68 Ω ... 1.99 kΩ for U_n=25 V

Display range	Resolution	Accuracy
0.00...9.99Ω	0.01Ω	±(2% m.v. + 3 digits)
10.0...99.9Ω	0.1Ω	
100...999Ω	1Ω	
1.00...1.99kΩ	0.01kΩ	

- In the 3-pole method, the meter displays the uncertainty caused by the auxiliary probes resistance. Such uncertainty can be also evaluated using the following diagram:

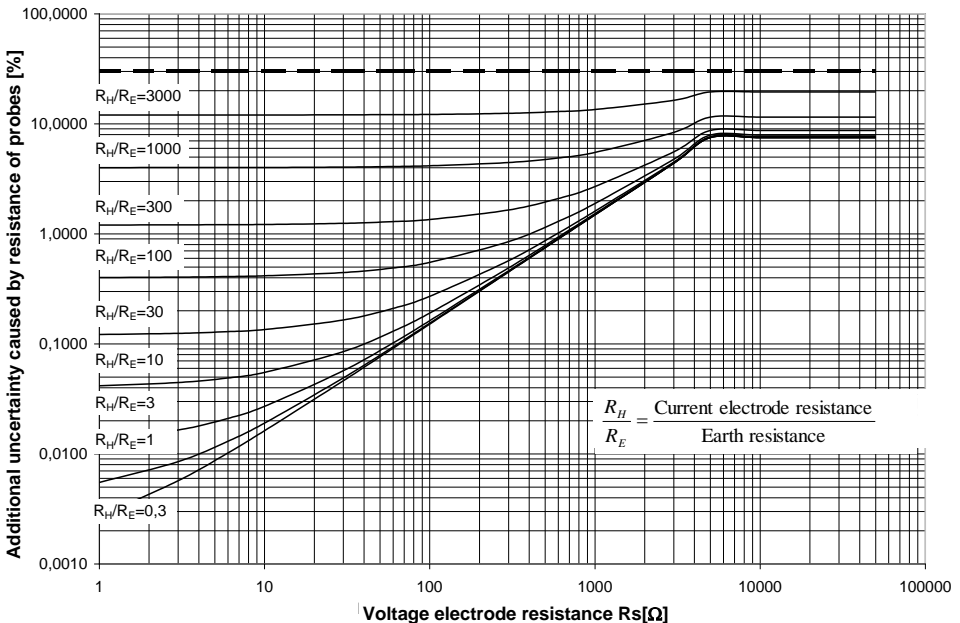

Auxiliary electrodes resistance and measurement accuracy

Measurement of resistance of auxiliary earth electrodes R_H and R_S

Display range	Resolution	Accuracy
000...999 Ω	1 Ω	$\pm(5\% (R_S + R_E + R_H) + 3 \text{ digits})$
1.00...9.99 k Ω	0.01 k Ω	
10.0...50.0 k Ω	0.1 k Ω	

Measurement of interference voltage U_N (RMS)

Internal resistance: about 100 k Ω

Display range	Resolution	Accuracy
0...100 V	1 V	$\pm(2\% \text{ m.v.} + 3 \text{ digits})$

Measurement of resistance of earth connection and equipotential bonding (R_{CONT})

Measurement method: conforming with EN 61557-4

Measuring range according to IEC 61557-4: 0,13 Ω ...199 Ω

Display range	Resolution	Accuracy
0.00...9.99 Ω	0.01 Ω	$\pm(2\% \text{ m.v.} + 3 \text{ digits})$
10.0...99.9 Ω	0.1 Ω	
100...199 Ω	1 Ω	

Note: Guaranteed are only the values with tolerances or limits. Values without tolerances are for information only.

Other technical specification

- a) type of insulationdouble, EN 61010-1 and IEC 61557 compliant
- b) measurement category (for 2000 m a.s.l.)IV 300 V acc. to EN 61010-1
- c) degree of protection of enclosure acc. to EN 60529 IP54
- d) maximum interference voltage for the R_{E2P} , R_{E3P} measurement 24 V
- e) maximum interference voltage for the R_{CONT} measurement 3 V
- f) maximum measured interference voltage 100 V
- g) R_{E2P} , R_{E3P} test current frequency 125 Hz
- h) R_{E2P} , R_{E3P} test voltage 25 V or 50 V
- i) R_{E2P} , R_{E3P} test current 20 mA
- j) maximum resistance of auxiliary electrodes 50 k Ω
- k) R_{CONT} test current (with shorted terminals for $U_{BAT} \geq 6,0 \text{ V}$) 200 mA
- l) maximum voltage at open terminals for R_{CONT} 13 V
- m) meter power supply R14 alkaline disposable or rechargeable batteries (4 pcs)
- n) number of R_E measurements > 1000 (5 Ω , 2 measurements per minute)
- o) dimensions 288 x 223 x 75 mm
- p) weight with batteries about 1.4 kg
- q) display LCD with backlight
- r) operating temperature -10...+55 $^{\circ}\text{C}$
- s) reference temperature +23 \pm 2 $^{\circ}\text{C}$
- t) storage temperature -20 $^{\circ}\text{C}$...+70 $^{\circ}\text{C}$
- u) humidity 20...90%
- v) reference humidity 40...60%
- w) time to AUTO-OFF 5 minutes
- x) altitude a.s.l. $\leq 2000 \text{ m}^*$
- y) the product meets the EMC requirements acc. to EN 61326-1 and EN 61326-2-2
- z) quality standard development, design and manufacturing are ISO 9001 compliant

NOTE

* Information about the use of meter at altitude from 2000 m to 5000 m

As for voltage inputs E, S, H the instrument is to be considered downgraded to measurement category CAT III 300 V to ground (max 300 V between inputs) or CAT IV 150 V to ground (max 150 V between inputs). Markings and symbols indicated on the instrument are to be considered valid when using it at altitude lower than 2000 m.

9.2 Additional information

Data on additional uncertainties are useful mainly when the meter is used in non-standard conditions and for metrological laboratories for the purpose of calibration.

9.2.1 R_E measurement

9.2.1.1 Additional uncertainty caused by resistance of auxiliary earth electrodes:

0%	R _H and R _S ≤ 100 Ω
7.5%	(R _H ≥ 5 kΩ or R _S ≥ 5 kΩ) and R _E ≥ 500 Ω
$\delta_{dod} = \pm \left(7,5 + \frac{R_H \cdot 0,004}{R_E} + 1,5 \cdot 10^{-8} \cdot R_H^2 \right)$ [%]	R _S ≥ 5kΩ and R _E ≤ 500Ω
$\delta_{dod} = \pm \left(\frac{R_S}{100000 + R_S} \cdot 150 + \frac{R_H \cdot 0,004}{R_E} + 1,5 \cdot 10^{-8} \cdot R_H^2 \right)$ [%]	remaining cases

The meter displays R_E, R_H and R_S in [Ω]. This uncertainty is calculated by the meter and displayed as ER.

9.2.1.2 Additional uncertainty caused by serial interference voltage

R _E	U _{wy}	Additional uncertainty [Ω]
0.00...9.99 Ω	25 V	±(0.01R _E + 0.012)U _Z ± 0.007U _Z ²
	50 V	±(0.01R _E + 0.012)U _Z ± 0.003U _Z ²
10.0...99.9 Ω	25 V, 50 V	±(0.001R _E + 0.05)U _Z ± 0.001U _Z ²
100 Ω...1.99 kΩ		±(0.001R _E + 0.5)U _Z ± 0.001U _Z ²

9.2.1.3 Additional uncertainty caused by ambient temperature

± 0.25 digit/°C for U_{wy} = 50 V, ± 0.33 digit/°C for U_{wy} = 25 V

9.2.1.4 Additional uncertainties according to IEC 61557-5

Working uncertainty or influencing factors	Reference conditions or operating range	Designation	Additional uncertainty
Position	Reference position $\pm 90^\circ$	E ₁	0
Power supply voltage	$U_{\text{nom}} \div U_{\text{min}}$	E ₂	0
Storage temperature	$0 \div 35^\circ\text{C}$	E ₃	acc. to formula from 9.2.1.3
Serial interference voltage	3V	E ₄	acc. to formula from 9.2.1.2
Resistance of electrodes and auxiliary earth electrodes	From 0 to 100R _E , but $\leq 50 \text{ k}\Omega$	E ₅	acc. to formula from 9.2.1.1
Working uncertainty	$B = \pm \left(A + 1,15 \sqrt{E_1^2 + E_2^2 + E_3^2 + E_4^2 + E_5^2} \right)$ where A = accuracy		

9.2.2 R_{CONT} measurement

9.2.2.1 Additional uncertainty caused by ambient temperature

$\pm 0.15\%/^\circ\text{C}$

9.2.2.2 Additional uncertainties according to IEC 61557-4

Working uncertainty or influencing factors	Reference conditions or operating range	Designation	Additional uncertainty
Position	Reference position $\pm 90^\circ$	E ₁	0
Power supply voltage	$U_{\text{nom}} \div U_{\text{min}}$	E ₂	0
Storage temperature	$0 \div 35^\circ\text{C}$	E ₃	$\pm 0.15\%/^\circ\text{C}$
Working uncertainty	$B = \pm \left(A + 1,15 \sqrt{E_1^2 + E_2^2 + E_3^2} \right)$ where A = accuracy		

10 Accessories

The current list of accessories can be found on the manufacturer's website.

10.1 Standard accessories

Standard set of equipment supplied by the manufacturer includes:

- MRU-21 meter,
- set of test leads:
 - ❑ 30 m lead on the reel (red) with banana plugs – **WAPRZ030REBBSZ**,
 - ❑ 15 m lead on the reel (blue) with banana plugs – **WAPRZ015BUBBSZ**,
 - ❑ 2.2 m lead (black) with banana plugs – **WAPRZ2X2BLBB**,
 - ❑ 1.2 m lead (blue) with banana plugs – **WAPRZ1X2BUBB**,
 - ❑ K01 crocodile clip, black – **WAKROBL20K01**,
 - ❑ K02 crocodile clip, blue – **WAKROBU20K02**,
- auxiliary electrode, 30 cm (2 pcs.) – **WASONG30**,
- carrying case for the meter and accessories,
- harness (2 pcs, long and short) – **WAPOZSZEKPL**,
- USB cable – **WAPRZUSB**,
- LR14 batteries, (4 pcs),
- user manual,
- factory calibration certificate.

10.2 Optional accessories

Additionally, the following items that are not included in the scope of standard equipment can be purchased from the manufacturer or the distributors:

WAPRZ025BUBBSZ



- 25 m test lead (blue)

WASONG80V2



- Auxiliary electrode, 80 cm

WAZACIMA1



- Vise

WAPRZ050YEBBSZ



- 50 m test lead

WAFUTL3



- case L-3 (for auxiliary electrodes 80 cm)
- calibration certificate with accreditation

11 Manufacturer

The manufacturer of the device and provider of warranty and post-warranty service:

SONEL S.A.

Wokulskiego 11
58-100 Świdnica
Poland

tel. +48 74 858 38 60

fax +48 74 858 38 09

E-mail: export@sonel.pl

Web page: www.sonel.pl

NOTE

Service repairs must be performed solely by the manufacturer.

12 Laboratory services

SONEL Testing and Calibration Laboratory has been accredited by the Polish Center for Accreditation (PCA) - certificate no. AP 173.

Laboratory offers calibration for the following instruments that are used for measuring electrical and non-electrical parameters.



AP 173

● METERS FOR MEASUREMENTS OF ELECTRICAL PARAMETERS

- voltage meters,
- current meters (including clamp meters),
- resistance meters,
- insulation resistance meters,
- earth resistance and resistivity meters,
- RCD meters,
- short-circuit loop impedance meters,
- power quality analyzers,
- portable appliance testers (PAT),
- power meters,
- multimeters,
- multifunction meters covering the functions of the above-mentioned instruments,

● ELECTRICAL STANDARDS

- calibrators,
- resistance standards,

● METERS FOR MEASUREMENTS OF NON-ELECTRICAL PARAMETERS

- pyrometers,
- thermal imagers,
- luxmeters.

The **Calibration Certificate** is a document that presents a relation between the calibration standard of known accuracy and meter indications with associated measurement uncertainties. The calibration standards are normally traceable to the national standard held by the National Metrological Institute.

According to ILAC-G24 „Guidelines for determination of calibration intervals of measuring instruments”, SONEL S.A. recommends periodical metrological inspection of the instruments it manufactures no less frequently than once every **12 months**.

For new instruments provided with the Calibration Certificate or Validation Certificate at the factory, re-calibration should be performed within **12 months** from the date of purchase, however, no later than **24 months** from the date of purchase.









ATTENTION !

The person performing the measurements should be absolutely sure about the efficiency of the device being used. Measurements made with an inefficient meter can contribute to an incorrect assessment of the effectiveness of health protection and even human life.

WARNINGS AND INFORMATIONS DISPLAYED BY THE METER

ATTENTION!

The meter is designed for measurements at interference voltages which do not exceed 24V for the RE measurements and 3V for the RCONT measurements. The voltage is measured up to 100V, but above 50V is indicated as dangerous. The meter must not be connected to voltages exceeding 100 V.

$\overset{30}{> 24V}$ and 	Excessive interference voltage (> 24V). The measurement is not possible. Disconnect the source of interference or try another location of the probes.
$\overset{10}{> 50V}$ and  and continuous audio signal	Interference voltage during the R_E measurement exceeds 50V! Disconnect the meter immediately! Disconnect the voltage source before you reconnect the meter.
$\overset{DFL}{> 50V}$ and  and continuous audio signal	Interference voltage during the R_E measurement exceeds 100V! Disconnect the meter immediately! Disconnect the voltage source before you reconnect the meter.
$> 3V$ and 	Excessive interference voltage during the RCONT measurement (> 3Vrms). The measurement is not possible. Disconnect the source of interference.
$> 50V$ and  and continuous audio signal	Interference voltage during the R_{CONT} measurement exceeds 50V! Disconnect the meter immediately! Disconnect the voltage source before you reconnect the meter.
 with the electrode (electrodes) name and	Interruption in measuring circuit or resistance of test probes higher than 60 k Ω . Check connections in the test circuit or reduce the probe resistance by driving it into the soil again.
E_r (in the field below Cell) and measurement result and 	Uncertainty of the R_E measurement caused by probes resistance exceeds 30%. Reduce the probe resistance by driving it into the soil again or by dampening the soil in its immediate vicinity.
$>1,99k\Omega$	The R_E measuring range is exceeded.
$>199\Omega$	The R_{CONT} measuring range is exceeded.
$>50k\Omega$	Test probes resistance above 50k Ω (but below 60k Ω).
DFL	The interference voltage for RE exceeds 100V (the symbol is displayed instead of the result).
NOISE!	Interference voltage equal to 1.3Vrms during the R_{CONT} measurement. The measurement results may include an additional uncertainty. Interference voltage above 10V during the R_E measurement, or unstable measurement result, or the measured voltages or currents are too low in relation to the noise.
$no, 5$ and NOISE!	Measured voltages or currents are too low in relation to the noise. (The symbol $no, 5$ is displayed instead of the result).
OFF	The default leads resistance has been restored in the R_{CONT} function. The user's autozeroing of the leads is OFF.
	Status of batteries. Batteries charged. Batteries discharged. After replacing the batteries, set the power supply type. The correct charge indication depends on this setting (the discharge characteristics of disposable and rechargeable batteries are different).
bAt	Replace or recharge the batteries.
Err and error No. on the main reading field	Error detected during the self-check. The MRU-20 instruments are often exposed to strong electromagnetic disturbance which can affect the internal registers. The meter automatically controls some parameters and displays the error messages if necessary. Displaying an error message may be caused by a momentary influence of external factors. Switch off, and again switch on the instrument. If the problem persists, send the meter for servicing.
$\overset{10}{\text{°C}}$ and 	Maximum allowed temperature inside the meter is exceeded.



SONEL S.A.
Wokulskiego 11
58-100 Świdnica
Poland



+48 74 858 38 60
+48 74 858 38 00
fax +48 74 858 38 09

e-mail: export@sonel.pl
www.sonel.pl