



USER MANUAL

BATTERY QUALITY ANALYZER

BT-120



USER MANUAL

BATTERY QUALITY ANALYZER

BT-120



**SONEL S.A.
Wokulskiego 11
58-100 Świdnica
Poland**

Version 1.01 23.10.2024

The BT-120 is a modern, top quality measuring instrument which is easy and safe to use, provided that the principles presented in this manual are observed. In addition, becoming acquainted with the manual will help you avoid measuring errors and will prevent any possible problems with the operation of the meter.

CONTENTS





1	General information	5
1.1	Safety symbols	5
1.2	Safety	5
1.3	General characteristics	6
2	Quick start	7
3	Interface and configuration	8
3.1	Design and functions	8
3.2	Display	9
3.3	Keyboard	10
3.4	Configuration of the meter	11
4	Impedance measurements	13
4.1	Insert test probe	13
4.2	Calibration of test leads	13
4.3	Single battery measurement	16
4.3.1	Impedance measurement	17
4.3.2	Range adjustment	17
4.3.3	Manual Hold	17
4.3.4	Auto Hold	17
4.3.5	Auto Rec	17
4.3.6	Average of measurement data	18
4.3.7	Limit	19
4.3.7.1	LIMIT on/off	19
4.3.7.2	LIMIT set up – direct input	20
4.3.7.3	LIMIT setting – reference string	21
4.4	String measurement	22
4.4.1	String measurement progress indicator	23
4.4.2	Cursor	23
4.4.3	String recording	24
5	V.A measurement	25
5.1	Insert test probe	25
5.2	Measurement settings	25
5.3	Single battery measurement	26
5.3.1	Range adjustment	26
5.3.2	Manual Hold	26
5.3.3	Auto Hold	27
5.3.4	Auto Rec	27
5.4	String measurement	28
5.5	Capacity (charge / discharge test)	29
5.5.1	Preparing the charge / discharge test	29
5.5.2	Charge / discharge test	29
5.5.3	Recall charge / discharge test	31
6	Memory	32
6.1	Checking memory space	32
6.2	Memory management	33
6.2.1	Displaying recordings	33
6.2.2	Erasing recordings	34
6.3	String management	36
6.3.1	String lists	36

6.3.2	<i>Editing strings</i>	37
6.3.3	<i>Erasing strings</i>	39
6.4	<i>String recording management</i>	40
6.4.1	<i>Impedance recordings</i>	40
6.4.2	<i>V.A recording</i>	42
7	<i>Analyzer</i>	44
8	<i>Power supply</i>	47
9	<i>Cleaning and maintenance</i>	47
10	<i>Storage</i>	47
11	<i>Dismantling and utilisation</i>	47
12	<i>Technical data</i>	48
12.1	<i>Basic data</i>	48
12.1.1	<i>Internal resistance</i>	48
12.1.2	<i>DC voltage</i>	48
12.1.3	<i>AC voltage</i>	48
12.1.4	<i>DC current</i>	48
12.1.5	<i>AC current</i>	48
12.1.6	<i>Temperature</i>	49
12.1.7	<i>Ripple voltage</i>	49
12.1.8	<i>Measurement current</i>	49
12.2	<i>Other technical data</i>	49
13	<i>Accessories</i>	50
13.1	<i>C-130BE current clamp</i>	50
13.1.1	<i>Basic data</i>	50
13.1.2	<i>Other technical data</i>	50
14	<i>Manufacturer</i>	50

1 General information

1.1 Safety symbols

The following international symbols are used in the device and/or in this manual:

	Warning. See explanation in the manual		Double insulation (protection class)		Declaration of Conformity with EU directives (Conformité Européenne)
	Do not dispose of with other household waste		Attention, risk of electric shock		

Measurement categories according to EN IEC 61010-2-030:

- **CAT II** – concerns measurements performed in circuits directly connected to low voltage installations,
- **CAT III** – concerns measurements performed in buildings installations,
- **CAT IV** – concerns measurements performed at the source of low voltage installation.

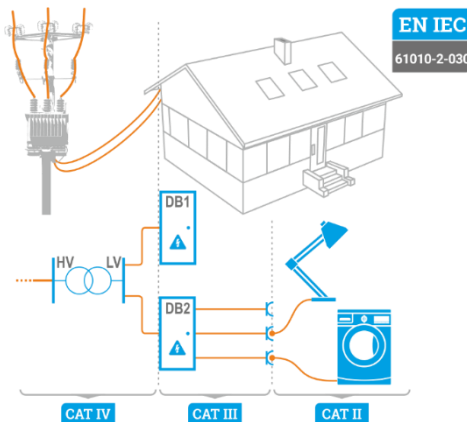

1.2 Safety

To avoid electric shock or fire, you must observe the following guidelines:

- Please use the unit after reading the safety information. Use only the designated operation method.
- Do not use in environments with combustible gas, steam or high humidity. Do not use a damaged unit.
- Do not use any unit with an abnormal operation.
- Do not apply a higher voltage than the rated voltage between the terminals or between respective terminals and the ground.
- Use the appropriate terminals, range, function or range when taking a measurement. Replacement parts should be the manufacturer's designated parts.
- Measurements cannot be taken while the battery is charging.
- Before battery replacement, be sure to disconnect any power cord, test lead, or accessories from the unit.

1.3 General characteristics

BT-120 measures internal resistance, voltage and temperature simultaneously, determining the degree of battery deterioration.

String recording is designed for battery maintenance and management. The function can accumulate saved measurement data systematically and analyse the degree of deterioration, and can be a reference to estimate battery charge time.

Saved data can be transferred to PC Software via Bluetooth.

Major functions

- **Can measure without stopping the UPS system.** High-precision AC resistance measurement technology enables to measure the UPS system while the UPS system is being loaded.
- **Precise measurement.** A 4-terminal test lead enables precise measurement of the internal resistance of the battery without including the test probe's own resistance, as well as contact resistance.
- **Simultaneous measurement of resistance, voltage, temperature, and currents.** Without changing function, resistance-voltage-temperature, voltage-temperature or voltage-currents can be measured simultaneously. Current measurements can only be performed with a current clamp.
- **LIMIT.** The LIMIT function can set up a limit of resistance and voltage. This enables to determine the battery deterioration status during measurement.
- **8 MB Memory.** The 8 MB memory installed can save more than 100,000 pieces of measurement data. String: max. 250. Cell: max. 251 cell. Slot measurements: max. 60 times.
- **AutoRec (Auto Record).** Use this mode to record measurement data automatically at a designated recording post. The function can measure many batteries consecutively and conveniently.
- **Sonel Reader software.** Measurement data can be downloaded to a PC.
- **Pin type test probe.** The end of pin type test probe may insert into a 5 mm diameter hole which can measure the battery terminals without taking the battery terminal covers off.
- **Ripple voltage measurement.** Measures the DC circuit of the inverter to charge and measures the voltage ripple (AC component remaining). A large ripple voltage is one of the causes of accelerating battery deterioration.

2 Quick start

1



Turn the meter on.

2



Connect the meter to the tested object.

3



Select the measurement.

4

Start

Start the measurement.

5



Analyse the results.

6











Turn the meter off.

3 Interface and configuration







3.1 Design and functions

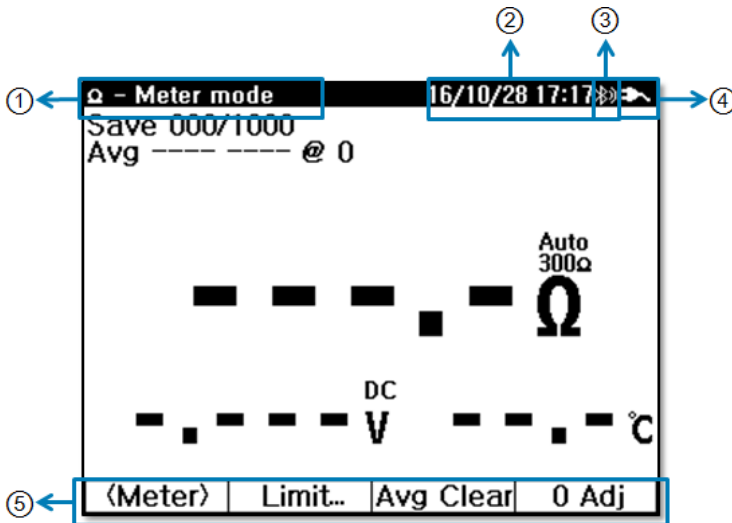

1	Display	LCD display
2	Soft keys	Assigned to the displayed soft key
3	Function keys	<p>Function keys</p> <ul style="list-style-type: none">  Impedance (resistance) measurement  Voltage and current measurement  Memory of the meter  Analyzer function  Select measurement range  <ul style="list-style-type: none"> ▪ Hold (press briefly) ▪ AutoHold (press and hold)  <ul style="list-style-type: none"> ▪ Settings (press briefly) ▪ Backlight on/off (press and hold)  Power on/off
4	Power adapter socket	Power adapter socket for charging
5	Currents terminal	Input terminal for a current clamp
6	Voltage terminal	Input terminal for a V.A probe
7	Impedance terminal	Input terminal for a 4-lead test probe

3.2 Display



1	Function name	Name of active function
2	Time	Current date and time
3	Bluetooth status	Icon indicating Bluetooth transmission status <ul style="list-style-type: none">  Bluetooth off  Preparing Bluetooth transmission  Ready for Bluetooth transmission. Connecting to a PC  Connected to a PC. Bluetooth transmission active
4	Battery Charging status	 Indication of the battery charge level  AC adapter connected and charging
5	Soft keys	Function activated respectively by keys F1, F2, F3, F4







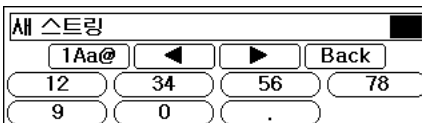
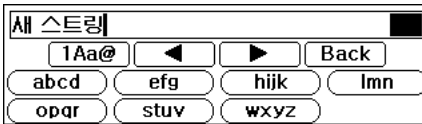
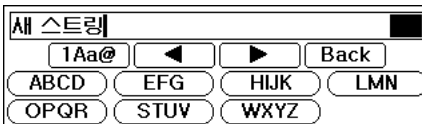
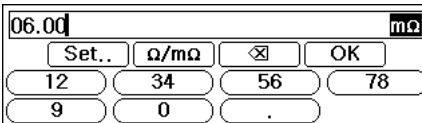
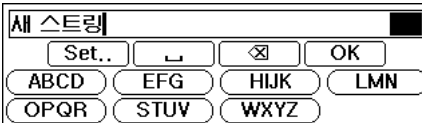

3.3 Keyboard

The keyboard is used for inserting names and numbers etc. The virtual keys are controlled by the corresponding soft keys (does not apply to the power button).

Keyboard keys assigned to F1, F2, F3, and F4 require a single press. Letter and number keys require multiple pressing in order to obtain an appropriate symbol. For example, if you want to get a “B”, press

 2 times.



- | | |
|---|--|
|  | View buttons for cursor movement and changing the keyboard |
|  | Change keyboard (uppercase/lowercase/numbers) |
|  | Move backwards |
|  | Move forwards |
|  | Back to the previous menu |
|  | Space |
|  | Measurement unit |
|  | Backspace |
|  | Accepts the inserted value |

F1
F2
F3
F4

3.4 Configuration of the meter

In order to enter Settings press  briefly. The screen below will be displayed.

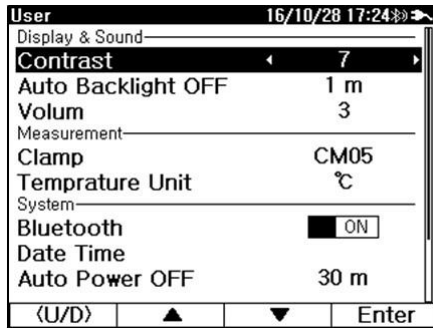

The movement within the menu is controlled by keys F1, F2, F3, F4, which are assigned to the soft keys at the bottom of the screen. The default move option is up/down **<U/D>** – in this mode, you can highlight a menu option using the arrows **▲▼**. In order to switch the option's value, change the movement to left/right **<L/R>** by double pressing the corresponding button **F1** – the arrows **◀▶** will be displayed.

1

F1 Select **<U/D>**.

2

F2 F3 Press **▲▼** to move the cursor to the desired parameter.

3

F1 Select **<L/R>**.

4

F2 F3 Press **◀▶** to select the setting.

5

F4 When **ENTER** is displayed, select it in order to open an additional display.

Menu	Set range	Description
Display contrast	1, 2, ..., 14, 15	Display contrast
Auto Backlight OFF	Off, 1, 3, 5, 10, 20, 30, 60 minutes	The backlight automatically turns OFF when there is no button operation within the set time
Language	English, Polish, Korean	Interface language
Volume	Mute, 1, 2, 3	Buzzer loudness
Temperature Unit	°C, °F	Set temperature unit
Bluetooth	On/Off	Bluetooth on/off
Printer	On/Off	Printer on/off
Date Time	Y/M/D h:m:s	Set date and time
Automatic Power OFF	Off, 1, 3, 5, 10, 20, 30, 60 minutes	Automatic shutdown of the device when no button is pushed within the set time. The function does not activate if the device is connected to an AC power line or if a PC is connected
Data Format	-	Erases all saved data
Factory Setting	-	Resets all settings
System Info	-	Indicates information including hardware version, firmware version, and serial number of the device

4 Impedance measurements



WARNING

- During measurements, there is a voltage of up to 400 volts on the test leads.
- When measuring a high-voltage battery of 100 V or more, there is a danger of electric shock. It is dangerous, so stay safe.

4.1 Insert test probe

A 4-terminal pin probe is provided to measure impedance. For safe and accurate measurement, insert the probe precisely.



Impedance probe

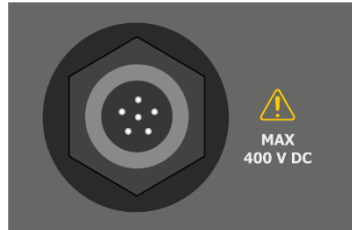

Impedance input terminal

4.2 Calibration of test leads

In order to eliminate the impact of the resistance of test leads on the measurement result, the compensation (nulling) of their resistance may be performed.

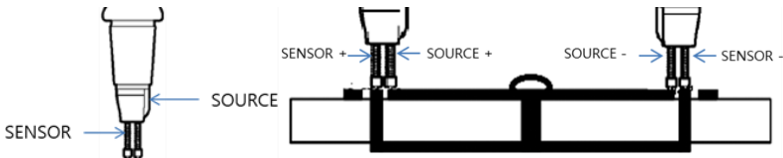

Parallel pin type

- **Parallel tip type:** The protruding side is the source, and the other side is the sensor.
- The **source pin** is connected to the upper side, and the **sensor pin** is connected to the metal part below.

1

Ω

Enter Impedance Display.

2

F4
▼
F2

Select **More...** and then **0 Adj.** Press and hold **0 Adj** to start adjustment.

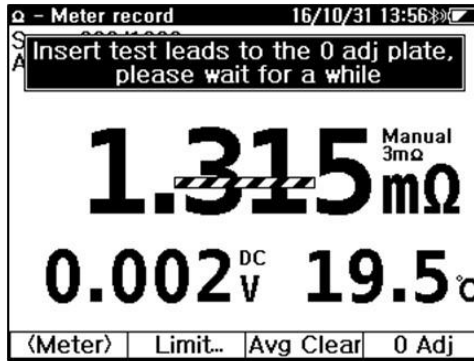

3

Insert the probe tip into the hole of the adjustment bar and press the probe down vertically (both the SOURCE tip and SENSOR tip). The device will start the adjustment on all impedance ranges. Do not remove the test probe from the adjustment bar until a completion message is displayed.





- Adjustment will be cancelled if the probe is not inserted into the hole of the board within 5 seconds after the start of the adjustment.

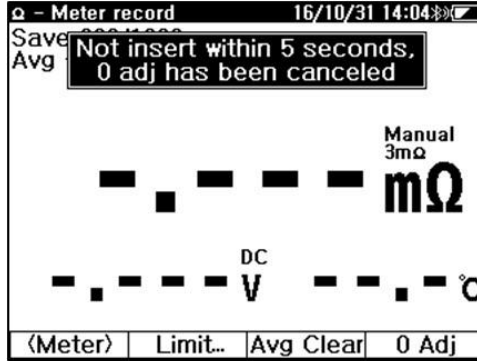

- If the probe is faulty or improperly inserted into the adjustment bar, the value will be out of the expected range, and the adjustment will be cancelled.

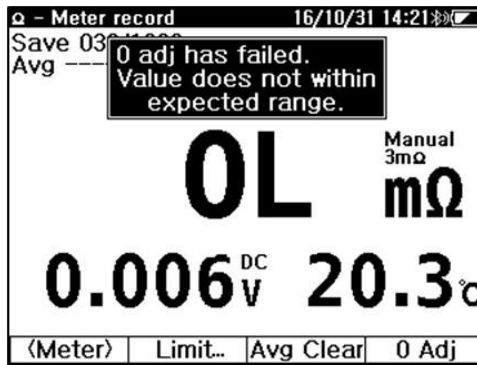

4.3 Single battery measurement

The method performs a single measurement. Measurement data and time can be saved. Saved data is displayed in order of measurement time.

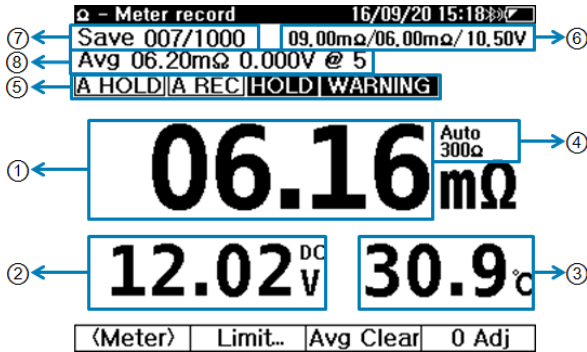

1	Impedance	Impedance value
2	Voltage	Voltage value. Voltage is always displayed during impedance measurement
3	Temperature	Temperature value
4	Range	Displays the current measurement range <ul style="list-style-type: none"> Press RANGE briefly to manually change the range Press and hold RANGE to change the mode to Auto / Manual
5	Measurement mode, result assessment	Displays measurement mode and result assessment A HOLD Auto Hold mode is active A REC Auto Record mode is active HOLD Manual Hold mode is active PASS WARNING Value assessment in relation to set limits FAIL
6	Limits	Currently set limit values. Displayed when limits are active. Ω Upper Limit 2 / Ω Upper Limit 1 / V Lower Limit
7	Number of recordings	Number of recordings within the memory
8	Average	Average impedance calculated from accumulated impedance measurement data

4.3.1 Impedance measurement

1

 Ω

Go to impedance measurement.

2

F1 Select <Meter>.



3

Connect the test probe to the battery terminal. Push the probe in to make contact.

4

Read the measurement result.

4.3.2 Range adjustment

- Press  briefly to change the range.
- Press and hold  to set Auto Range on/off.
- Voltage measurement in impedance mode always operates in Auto Range.

4.3.3 Manual Hold

Press  briefly to hold the measurement results. If pressed once again, the HOLD mode is released, and the current measurement is displayed.

4.3.4 Auto Hold

Press and hold  to enable or disable Auto Hold mode. When this mode is active, **A HOLD** is displayed. If the measurement result becomes stable for more than 2 seconds, it stays on the screen.

4.3.5 Auto Rec

- Auto Rec function is activated with the Auto Hold function simultaneously. When this mode is active, **A REC** is displayed. When the measurement value remains static on the screen, it is automatically saved to the memory.
- In single battery mode, the device can save a max. 1000 recordings of impedance, voltage, currents, and temperature. The recorded data is displayed on the upper display – i.e. [SAVE 000/1000].
- When performing consecutive measurements on multiple batteries, use Auto Hold+Auto Rec mode (**A HOLD+A REC**). The user can measure and save measurement data of multiple batteries consecutively without operating the device. All one has to do is connect the probes to one battery and then to the next – the results will automatically save to memory.



When measurement data is saved through Auto Rec, different buzzer sounds signal different result assessments.





Short (100 ms) – 1 time

Long (300 ms) – 2 times

Short (100 ms) – 2 times and Long (400 ms) – 1 time. Total 3 times

4.3.6 Average of measurement data

Displays the average of consecutive, accumulated measurement data – impedance and voltage.

1 Once **A HOLD+A REC** data is saved, the data average is updated.

2 **F3** Select **Avg Clear** to erase the previous average value.

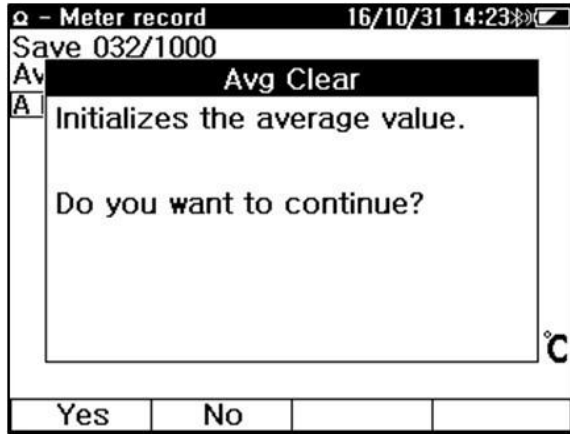

3 Average is not saved to the memory.

4.3.7 Limit

Limits are the base of the measurement result assessment: PASS, WARNING or FAIL. The limit function provides for Resistance – Ω Upper Level 1 (WARNING), Ω Upper Level 2 (FAIL) and for Voltage – V Lower Level (WARNING) as below.

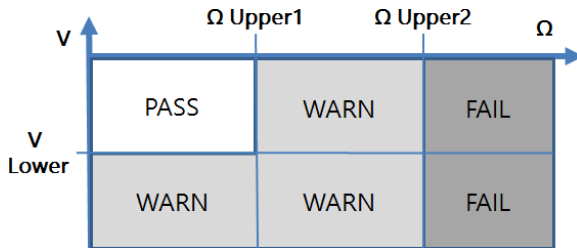

- If the impedance is higher than Upper 2, the assessment is FAIL.
- If voltage is higher than LOWER and impedance is lower than Upper 1, the assessment is PASS.
- All other cases result in a WARNING.

The assessment of voltage is based on its absolute value. Therefore, connecting the test leads in the wrong direction (+ / -) is irrelevant.

4.3.7.1 LIMIT on/off

1

Ω

Go to impedance measurement.

2

F2

Select **Limit...**

3

F1

Activate limit function.

[Limit] ► [Limit]

4

LIMIT value (Ω Upper 2 / Ω Upper 1 / V Lower) is displayed on the measurement screen, i.e.:
04,50m Ω /03,90m Ω /10,50V

4.3.7.2 LIMIT set up – direct input

1 F2 Select **Limit...**

2 F1 Activate limit function.
[Limit] ► [Limit]

3 F2 Select **Edit...**

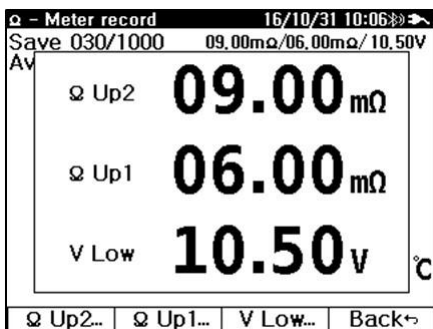

4 F1 F2 F3 Select [Ω Up2...], [Ω Up1...], [V Low...] to edit.

5 When the keyboard is up, input the desired value.

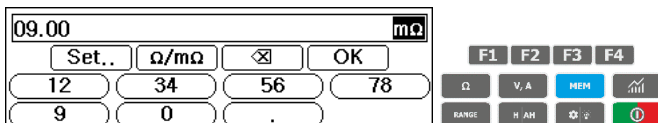

6 F4 Select **OK** to set up the desired input value.

7 F4 Select [**Back** \leftarrow] 2 times to return to the initial menu.

4.3.7.3 LIMIT setting – reference string

The set of limits can be copied from one string to another.

1

F2 Select **Limit...**

2

F1 Activate the limit function.

[Limit] ► [Limit]

3

F3 Select **Refer...** A list of existing strings will be displayed.

4

F1 F2 Select ▲ ▼ to backlight the desired string.

5

F3 Select **OK** to apply.

4.4 String measurement

The function is designed for continuous management and maintenance of energy storage systems. One string contains multiple cells. There can be multiple sets of measurement results for each cell. This way, the user can monitor the condition of each cell over time.

- String name, battery model, limit value and the number of batteries can be set up in the string recordings.
- Measurement data is saved for the selected string.
- Each string contains max. 60 cells, each with individual measurement results.
- The user can view and erase the measurement data of a string.

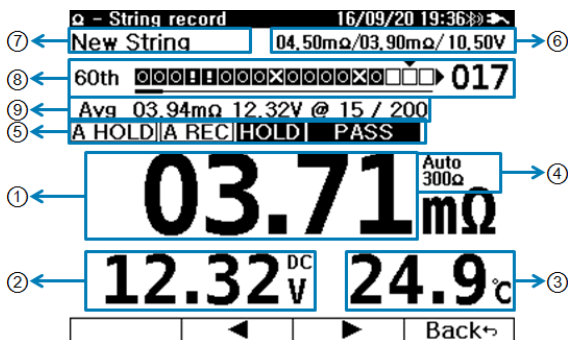



1	Impedance	Impedance value
2	Voltage	Voltage value. Voltage is always displayed during impedance measurement
3	Temperature	Temperature value
4	Range	Displays current measurement range <ul style="list-style-type: none"> • Press RANGE briefly to change the range manually • Press and hold RANGE to change the mode to Auto / Manual
5	Measurement mode, result assessment	Displays measurement mode and result assessment A HOLD Displays when Auto Hold mode is active A REC Displays when Auto Record mode is active HOLD Displays when the current measurement is on HOLD PASS WARNING LIMIT result when using the LIMIT function FAIL
6	Limits	Currently set limit values. Displayed when limits are active. Ω Upper Limit 2 / Ω Upper Limit 1 / V Lower Limit
7	Number of recordings	Number of recordings within the memory
8	String measurement progress indicator	Indicates the current cell within the string.
9	Average / Recording	When the CURSOR position is empty, the accumulated average of impedance and voltage is displayed. When the CURSOR position is on DATA, the current measurement is displayed.

4.4.1 String measurement progress indicator

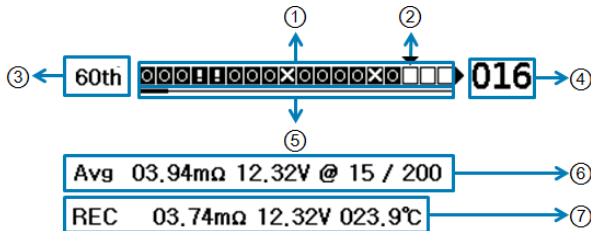
The recording process bar (line) indicates the current recording process status and result assessment.



1	Recording cell	An empty cell means that the cell is not measured. Measured cells show the following assessments:  PASS Cell: PASS  WARNING Cell: WARNING  FAIL Cell: FAIL
2	CURSOR	Indicates the current cell within the string. Move to an empty cell in order to save data, or move to a filled-in cell in order to view measurement results.
3	Number of measurements	Indicates the number of measurements of the string
4	Cursor location	Indicates the cell number of the cursor location
5	Scroll bar	Use to scroll through cells
6	Average	Indicates the average number of measurements and the number of recordings of the measured cell: avg. impedance, avg. voltage @ number of recordings / total number of cells
7	Recordings	Indicates the recordings of a cell where the cursor is located: impedance, voltage, temperature

4.4.2 Cursor

Move the cursor of the recording indication line in order to:

- select the next measurement cell or
- check the measurement data of a saved cell.

1 **F3** Select **◀▶** **Cursor**.

2 **F2 F3** Use **◀▶** to move the cursor.

3 If the selected cell is filled with data, the data will be shown. If the cell is empty, the current average values of the string will be displayed.

4 **F4** Select **[Back ↵]** to return to the initial menu.

5 If you continue measurements while **A HOLD+A REC** is active, you can save measurements in the cursor location. For example, if any wrong measurement data was saved by mistake, move the cursor to the cell to measure again – you will overwrite the data with new results.

4.4.3 String recording

To measure in string mode, first, create a string in the memory.

- 1  Enter Impedance Display.
- 2 F1 Set <String>.
- 3 F2 Select **String**. The string list will be displayed.
- 4 F1 F2 Use ▲▼ to select the string.
- 5 F3 Use **OK** to accept the string.
- 6 F1 F2 Use ▲▼ select the slot for the new measurement or the next slot of an existing measurement.
- 7 F3 Complete string selection using **OK**.
- 8 The meter is ready for measurements. **A HOLD+A REC** function is active.
- 9 F3 Check whether the cell number is the same as the number of the battery to be measured. If they are not the same, press the ◀▶ **Cursor** to move the cursor to the correct position.
- 10 Connect the test probe to the battery terminal. For correct 4-terminal measurement, press both inside and outside probe pins to connect both of them to the battery terminal. **A HOLD+A REC** holds and saves data.
- 11 Continue to measure the rest of the cells.

5 V.A measurement

5.1 Insert test probe

For safe and accurate measurement, insert precisely the accessories.



V.A Probe



Voltage input terminal



Current clamp



Clamp input terminal

5.2 Measurement settings

The device can measure DC voltage, AC voltage, DC currents, and AC ripple voltage. The V.A measurement function has 3 test settings. Each is an independently selected simultaneous measurement. In the V.A measurement function display, press **F1 (Meas. Set.)** to select:

- DC voltage & ripple voltage,
- DC voltage & DC current,
- AC voltage & AC current.

Meas Set
V dc & V ripple
V dc & A dc
V ac & A ac
{V dc &..} {Stri

- Saved recordings contain up to 1000 combinations of 2-measurement sets (3 different type sets as above).
- In string recording, each string can save up to 512, including 3 different type measurements.

5.3 Single battery measurement

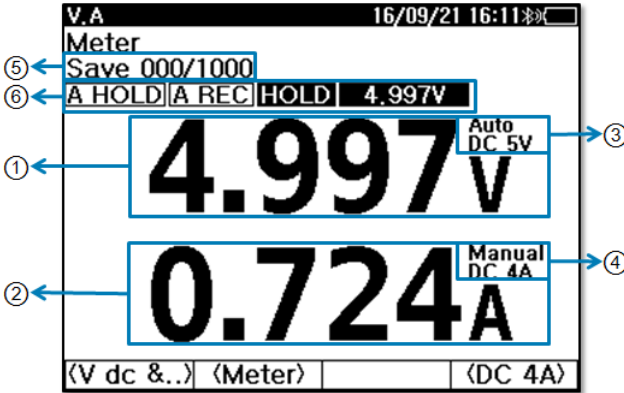

1	Measurement 1	V DC / V AC measurement value
2	Measurement 2	V ripple / A DC / A AC measurement value
3	Measurement 1 range	Displays the current measurement 1 range. In DC Voltage & DC Current measurement set: <ul style="list-style-type: none"> ▪ Press RANGE briefly to manually change the range ▪ Press and hold RANGE to change the mode to Auto / Manual
4	Measurement 2 range	Indicates the Measurement 2 range. Press F4 to change the range
5	Memory space	Indicates the number of recordings saved in the device
6	Measurement mode	Displays measurement mode A HOLD Auto Hold mode is active A REC Auto Record mode is active HOLD Manual Hold mode is active Current measurement data of measurement 1 is displayed in a smaller size

5.3.1 Range adjustment

- Press **RANGE** briefly to change the range.
- Press and hold **RANGE** to set Auto Range on/off.

5.3.2 Manual Hold

Press **H / AH** briefly to hold the measurement results. If pressed once again, HOLD mode is released, and the current measurement is displayed.

During Hold, **HOLD** and the measurement 1 value next to it is displayed.

5.3.3 Auto Hold

Press and hold  to enable or disable Auto Hold mode. When this mode is active, **A HOLD** is displayed. If the measurement result becomes stable for more than 2 seconds, it stays on the screen.

5.3.4 Auto Rec

- Auto Rec function is activated with the Auto Hold function simultaneously. When this mode is active, **A REC** is displayed. When the measurement value remains static on the screen, it is automatically saved to the memory.
- In single battery mode, the device can save max. 1000 V.A records. Save location is displayed on the upper display area – i.e. [SAVE 000/1000].

5.4 String measurement

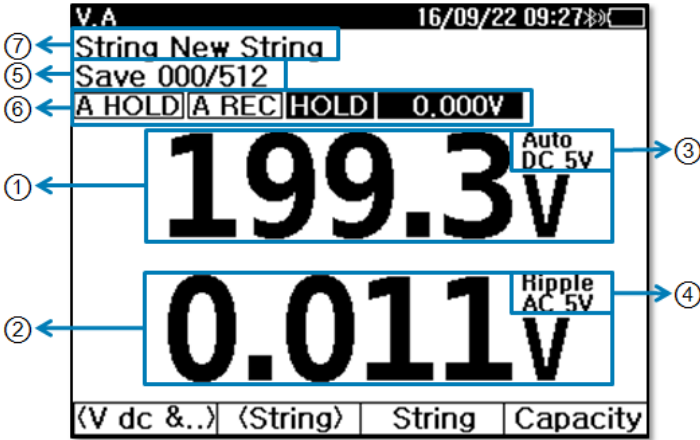

1	Measurement 1	V DC / V AC measurement value
2	Measurement 2	V ripple / A DC / A AC measurement value
3	Measurement 1 range	Displays the current measurement 1 range. In the DC Voltage & DC Current measurement set: <ul style="list-style-type: none"> Press RANGE briefly to change the DC Voltage range in order Press and hold RANGE to change the mode to Auto / Manual
4	Measurement 2 range	Indicates the Measurement 2 range. Press F4 to change the range
5	Memory space	Indicates the number of recordings saved in the unit.
6	Set Up status	Indicates current Set Up status of the measurement function A HOLD Displays when Auto Hold mode is active A REC Displays when Auto Record mode is active HOLD Displays when the current measurement is on HOLD The current measurement data of measurement 1 is displayed in a smaller size.
7	Selected string	Indicates the string selected by the user.

5.5 Capacity (charge / discharge test)

From the measured values, the device calculates the battery's capacity, which the user can compare with the rated parameters of the battery.

5.5.1 Preparing the charge / discharge test

Connect the wiring as shown below to measure the charge and discharge voltage and current of the battery.

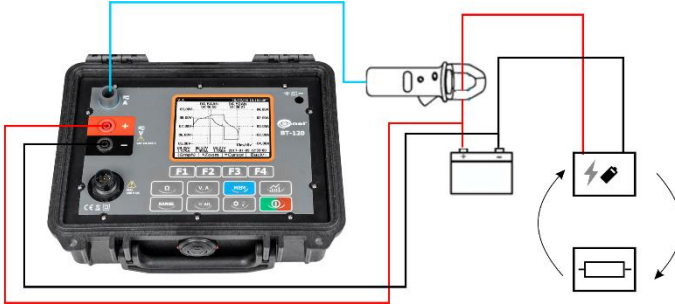

- This product performs only the measurement function. The devices for charging and discharging the battery are connected and operated separately.
- As the recording progresses, the sample interval is automatically adjusted. Maximum number of samples is 2400, at intervals of 1 s, 2 s, 10 s, 30 s, 1 min, 5 min, 15 min, 30 min, 1 h.

5.5.2 Charge / discharge test

1

V, A

Switch to V.A measurement mode

2

F1 Select **V DC & V ripple** measurement.

3

F4 Select **Capacity** to display the charge / discharge test screen. You can start recording or recall an existing recording.

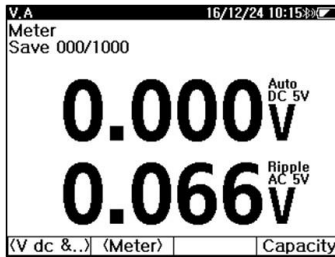

V.A Display

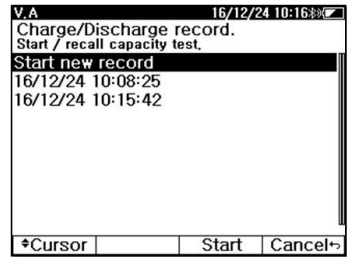

Charge / Discharge test initial screen

4

- F3 Select **Start**. The charge / discharge test setting screen is displayed.

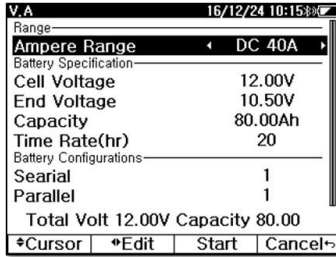

Charge / discharge test setup

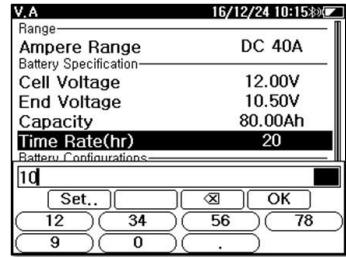

Edit test settings

Use **F1** to activate the **▲ ▼ Cursor**. Move the cursor using **F2▲** , **F3▼** . In order to exit, press **F4 [Back ←]**.

5

- F3 After all settings are completed, press **Start** to start recording. During recording, Auto Power OFF is disabled, and all keys except some soft keys are restricted. In the recording graph, the time ratio is automatically changed to show the entire recordings.

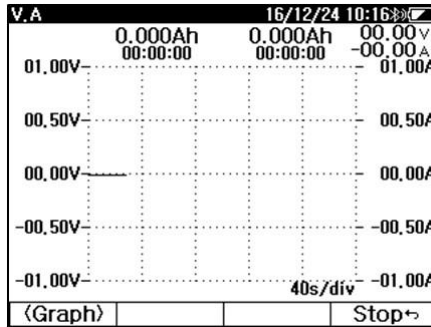

You can switch between the graph screen and the data screen with the **<Graph>/<Data>** soft key during recording. The graph screen displays the data being recorded as a graph, and the data screen shows the measured values instead of the graph.

Charge the fully discharged battery and remove the charger when charging is finished. Then connect to the load to perform a full discharge. Charge capacity, discharge capacity and efficiency are calculated by charging and discharging in 1 cycle.

6

- F4 If you press **Stop** during recording, the recording stops and is saved.

5.5.3 Recall charge / discharge test

1



Switch to VA measurement mode.

2

F1 Select **V DC & V ripple** measurement.

3

F4 Select **Capacity** to display the charge / discharge test screen. You can start recording or recall an existing recording.

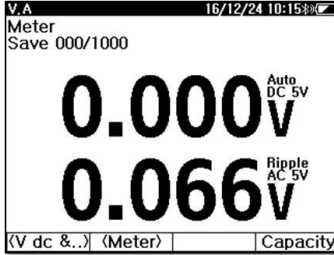

VA Display

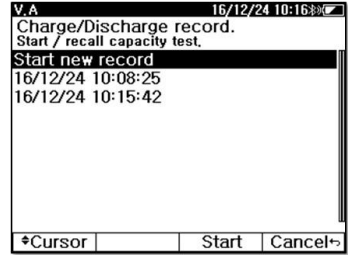

Charge / Discharge Test Initial Screen

4

Use F1 to activate the **▲▼ Cursor**. Move the cursor using F2▲, F3▼. In order to exit, press F4 [Back ←].

5

F3 Select **Recall**. The recording will be displayed on the screen.

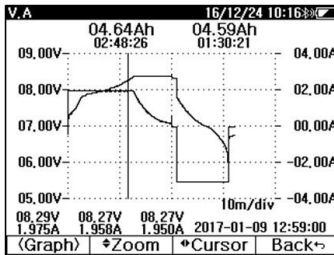

Charge / Discharge Test Recall -Graph

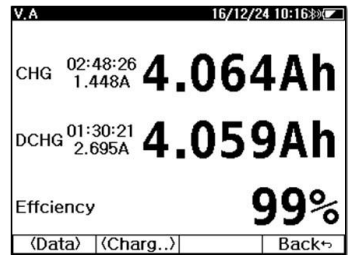

Charge / Discharge Test Recall - Data

On the graph screen, view the recording by zooming in and out and using the cursor. The data screen shows charge, charge time, discharge amount, and discharge time and calculates efficiency.

6 Memory

The device has the following memory structure.

- Ω Recording saves Impedance, Voltage, Temperature, and Measurement time.
- V, A Recording saves Measurement 1, Measurement 2, and Measurement time.
- Meter mode saves max. 1000 measurements in Ω recordings and V, A recordings
- String mode saves max. 250 Strings.
- Listed string used in Ω , V, A .
- Each string can save 60 measurements in Ω recording.
- Each Ω string recording measurement saves as a number of cells (max. 512)
- Each string saves max. 512 V, A recordings.

Meter mode	Ω	max. 1000 measurements
	V, A	max. 1000 measurements

String 001...250	Ω	String 001	1st measurement (Slot)	Cell 001
			...	Cell 512
	...	60th measurement (Slot)	Cell 001	
	...	Cell 512		
V, A	String 001	REC 001		
		...		
		REC 512		

6.1 Checking memory space

- To check used Memory, press Ω to display the percentage of remaining memory on the upper middle display.
- When the device is powered on, a message about memory space is displayed.

6.2 Memory management

6.2.1 Displaying recordings

1

MEM

Enter Memory. The window below will be displayed.

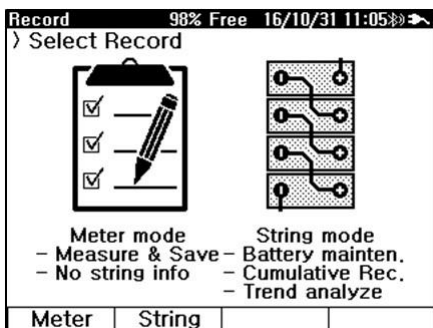

Select **Meter** and:

2

- press **F1 (Ω)** to display Ω records,
- press **F2 (V,A)** to display V.A records.

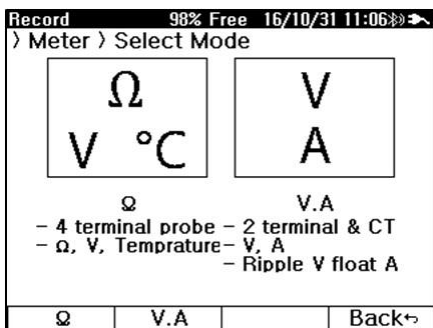

3

F2 In V.A recording mode, press **F2** to select the desired type of measurements.

Record 98% Free 16/10/31 11:05				
) Meter) Ω				
View / delete record.				
Ω	V	Temp	Time	
03.50 Ω	08.07V	29.6 $^{\circ}$ C	16/09/20	15:24:45
03.50 Ω	08.07V	29.4 $^{\circ}$ C	16/09/20	15:24:12
21.56m Ω	12.02V	30.9 $^{\circ}$ C	16/09/20	15:21:39
03.51 Ω	08.07V	30.7 $^{\circ}$ C	16/09/20	15:20:03
03.52 Ω	08.07V	30.7 $^{\circ}$ C	16/09/20	15:19:59
03.51 Ω	08.07V	30.2 $^{\circ}$ C	16/09/20	15:19:50
03.50 Ω	-08.07V	30.3 $^{\circ}$ C	16/09/20	15:19:42
06.16m Ω	-0.000V	26.1 $^{\circ}$ C	16/09/20	15:18:38
06.23m Ω	-0.000V	25.9 $^{\circ}$ C	16/09/20	15:18:29
06.19m Ω	-0.000V	25.8 $^{\circ}$ C	16/09/20	15:18:24
06.19m Ω	-0.000V	25.7 $^{\circ}$ C	16/09/20	15:18:20
*Cursor Delete Back				

Meter: Ω recording

Record 89% Free 16/09/22 10:42				
) Meter) V.A				
View / delete record.				
DC V	Ripple V	Time		
199.3V	0.011V	16/09/21	15:54:59	
298.9V	6.637V	16/09/21	15:53:24	
-299.0V	0L V	16/09/21	15:53:15	
435.9V	0.012V	16/09/21	15:52:33	
436.0V	0L V	16/09/21	15:51:04	
-436.0V	0L V	16/09/21	15:50:59	
-0.061V	0L V	16/09/21	15:50:45	
08.07V	0.032V	16/09/09	14:45:14	
08.07V	0.037V	16/09/09	14:45:11	
08.07V	0.036V	16/09/09	14:45:08	
08.07V	0.033V	16/09/09	14:45:05	
*Cursor (V dc &..) Delete Back				

Meter: V.A recording

4

Use **F1** to activate the \blacktriangle \blacktriangledown **Cursor**. Move the cursor using **F2** \blacktriangle , **F3** \blacktriangledown . In order to exit, press **F4** [Back \leftarrow].

6.2.2 Erasing recordings

1

MEM

Enter Memory. The window below will be displayed.

Record 98% Free 16/10/31 11:05			
) Select Record			
Meter mode		String mode	
- Measure & Save		- Battery mainten.	
- No string info		- Cumulative Rec.	
		- Trend analyze	
Meter	String		

2

Select **Meter** and:

- press **F1** (Ω) to display Ω records,
- press **F2** (V,A) to display V.A records.

Record 98% Free 16/10/31 11:06			
) Meter) Select Mode			
Ω		V A	
Ω		V.A	
- 4 terminal probe		- 2 terminal & CT	
- Ω , V, Temperature		- V, A	
		- Ripple V float A	
Ω	V.A		Back

3

Use **F1** to activate the **▲▼ Cursor**. Move the cursor using **F2▲**, **F3▼** in order to move the recording to erase. In order to exit, press **F4 [Back ←]**.

Record				
98% Free 16/10/31 11:05▶▶▶▶				
> Meter) Ω				
View / delete record.				
Ω	V	Temp	Time	
03.50 Ω	08.07 V	29.6 °C	16/09/20 15:24:45	
03.50 Ω	08.07 V	29.4 °C	16/09/20 15:24:12	
21.56 mΩ	12.02 V	30.9 °C	16/09/20 15:21:39	
03.51 Ω	08.07 V	30.7 °C	16/09/20 15:20:03	
03.52 Ω	08.07 V	30.7 °C	16/09/20 15:19:59	
03.51 Ω	08.07 V	30.2 °C	16/09/20 15:19:50	
03.50 Ω	-08.07 V	30.3 °C	16/09/20 15:19:42	
06.16 mΩ	-0.000 V	26.1 °C	16/09/20 15:18:38	
06.23 mΩ	-0.000 V	25.9 °C	16/09/20 15:18:29	
06.19 mΩ	-0.000 V	25.8 °C	16/09/20 15:18:24	
06.19 mΩ	-0.000 V	25.7 °C	16/09/20 15:18:20	
◀Cursor		Delete	Back←	

Meter: Ω recording

Record				
89% Free 16/09/22 10:42▶▶▶▶				
> Meter) V.A				
View / delete record.				
DC V	Ripple V	Time		
199.3 V	0.011 V	16/09/21 15:54:59		
298.9 V	6.637 V	16/09/21 15:53:24		
-299.0 V	OL V	16/09/21 15:53:15		
435.9 V	0.012 V	16/09/21 15:52:33		
436.0 V	OL V	16/09/21 15:51:04		
-436.0 V	OL V	16/09/21 15:50:59		
-0.061 V	OL V	16/09/21 15:50:45		
08.07 V	0.032 V	16/09/09 14:45:14		
08.07 V	0.037 V	16/09/09 14:45:11		
08.07 V	0.036 V	16/09/09 14:45:08		
08.07 V	0.033 V	16/09/09 14:45:05		
◀Cursor (V dc &..)		Delete	Back←	

Meter: V.A recording

4

F3 Select **Delete** to erase the highlighted recording.

Record				
89% Free 16/09/22 10:51▶▶▶▶				
> Meter) V.A				
View / delete record.				
Record Delete				
Delete selected record.				
Do you want to continue?				
Tip. long-pressing delete(F3) button, Can delete the entire.				
08.07 V	0.033 V	16/09/09 14:45:05		
Yes	No			

Press and hold the button **F3** to erase the indicated recording.

Record				
89% Free 16/09/22 10:51▶▶▶▶				
> Meter) V.A				
View / delete record.				
Record Delete				
Delete ALL Meter) VA Record. (Volts, Ripple, Amps)				
Do you want to continue?				
08.07 V	0.033 V	16/09/09 14:45:05		
Yes	No			

6.3 String management

6.3.1 String lists

1

MEM

Enter Memory.

2

F2 Select **String**.

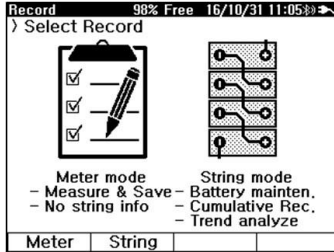

Recording Initial display

The screen displays the 'String list' menu. It shows a table with columns for '#', 'Name', 'Model', and 'Cell'. The data rows are as follows:

#	Name	Model	Cell
001	Demo String 001	RP-100	40
002	Demo String 002	RP-100	40
003	Demo String 003	RP-100	40
004	New String	Unknow	20
005			
006			
007			
008			
009			

At the bottom, there are four buttons: 'Cursor', 'Edit...', 'Select...', and 'Back'.

String List

3

Use **F1** to activate the **▲ ▼ Cursor**. Move the cursor using **F2▲** , **F3▼** . In order to exit, press **F4 [Back ↵]**.

4

F2 Select **Add...** to add a new string.

The screen displays the 'String Add, Edit' menu. It shows a table with fields for 'String Name', 'Battery Model', 'Number Of Cell', 'Impedance', 'Voltage', 'Limit', 'Upper1', 'Upper2', and 'Lower'. The data rows are as follows:

String Name	Demo String..
Battery Model	RP-100
Number Of Cell	40
Impedance	06.00mΩ
Voltage	12.00V
Limit	
Upper1	07.50mΩ
Upper2	09.00mΩ
Lower	10.00V

At the bottom, there are four buttons: 'Cursor', 'Edit', 'OK', and 'Cancel'.

5

Use **F1** to activate the **▲ ▼ Cursor**. Move the cursor using **F2▲** , **F3▼** . In order to edit it, select **Edit**. In order to exit, press **F4 [Back ↵]**.

6

F2 Select **Edit** to display the keyboard. Insert your data.

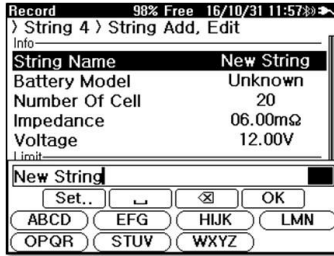

Add String 2

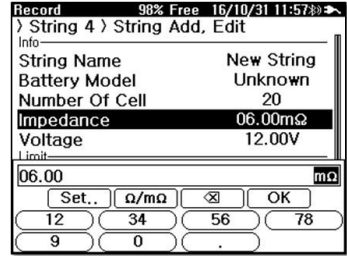

Add String 3

7

F3 Select **OK** to save. You will return to the string list.

6.3.2 Editing strings

1

MEM

Enter Memory.

2

F2 Select **String**.

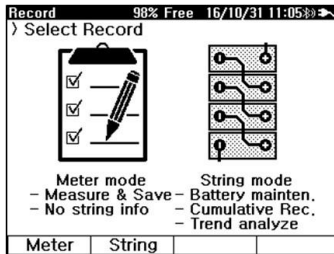

Recording Initial display

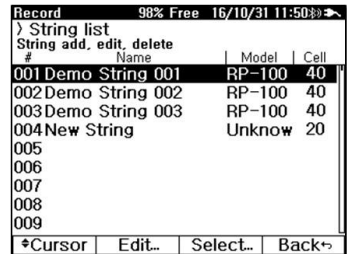

String List

3

Use **F1** to activate the **▲▼ Cursor**. Move the cursor using **F2▲**, **F3▼**. In order to exit, press **F4 [Back ←]**.

4

F2 Select **Edit...**

5

F1 Select **Edit**.

Record	
98% Free 16/10/31 14:52	
) String 1) String Add, Edit	
Info	
String Name	Demo String..
Battery Model	RP-100
Number Of Cell	40
Impedance	06.00mΩ
Voltage	12.00V
Limit	
Upper1	07.50mΩ
Upper2	09.00mΩ
Lower	10.00V
←Cursor	Edit OK Cancel→

6

Edit string contents.

Record	
98% Free 16/10/31 14:52	
) String 1) String Add, Edit	
Info	
String Name	Demo String..
Battery Model	RP-100
Number Of Cell	40
Impedance	06.00mΩ
Voltage	12.00V
Limit	
RP-100	
Set..	OK
ABCD	EFG
HIJK	LMN
OPQR	STUV
WXYZ	

7

F3 Select **OK** to save. You will return to the string list.

6.3.3 Erasing strings

1

MEM

Enter Memory.

2

F2 Select **String**.

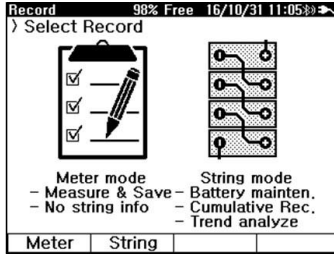

Recording Initial display



String List

3

Use F1 to activate the ▲▼ **Cursor**. Move the cursor using F2▲, F3▼. In order to exit, press F4 [Back ←].

4

F2 Select **Delete**. A confirmation message will appear.

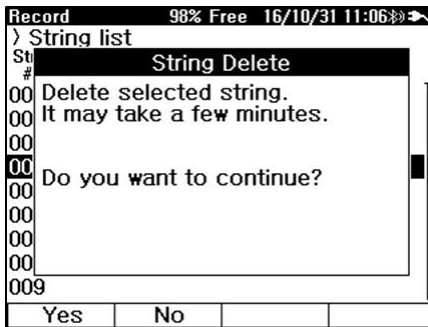

5

F1 Select **Yes**. Erasing many recordings takes a long time.

6.4 String recording management

6.4.1 Impedance recordings

1

MEM

Enter Memory.

2

F2 Select **String**.

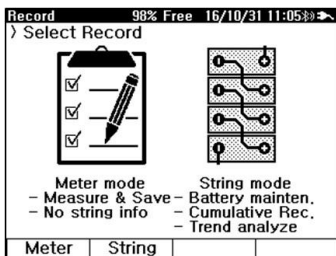

Recording Initial display

The screen displays 'Record 98% Free 16/10/31 11:50'. Below the title bar, it says '> String list'. The table has columns: '#', 'Name', 'Model', 'Cell'. The data rows are:

#	Name	Model	Cell
001	Demo String 001	RP-100	40
002	Demo String 002	RP-100	40
003	Demo String 003	RP-100	40
004	New String	Unknow	20
005			
006			
007			
008			
009			

At the bottom, there are four buttons: '*Cursor', 'Edit...', 'Select...', and 'Back<'. The 'Select...' button is highlighted.

String List

3

Use F1 to activate the ▲▼ **Cursor**. Move the cursor using F2▲, F3▼. In order to exit, press F4 [Back <].

4

F2 Select **Select...** The slots of string measurements will be displayed, containing measurement time, recording number and average impedance value.

The screen displays 'Record 98% Free 16/10/31 12:04'. Below the title bar, it says '> String 1 > Q > Slot list'. The table has columns: '#', 'Time', 'Record', 'Avg Ω'. The data rows are:

#	Time	Record	Avg Ω
060	16/08/05 22:43:25	40	07.98mΩ
059	16/07/22 22:43:24	40	07.85mΩ
058	16/07/08 22:43:23	40	07.74mΩ
057	16/06/24 22:43:22	40	07.61mΩ
056	16/06/10 22:43:21	40	07.53mΩ
055	16/05/27 22:43:20	40	07.45mΩ
054	16/05/13 22:43:19	40	07.36mΩ
053	16/04/29 22:43:18	40	07.29mΩ
052	16/04/15 22:43:17	40	07.23mΩ
051	16/04/01 22:43:16	40	07.10mΩ
050	16/03/18 22:43:15	40	07.08mΩ

At the bottom, there are four buttons: '*Cursor', 'Delete', 'Select...', and 'Back<'. The 'Select...' button is highlighted.

5

Use F1 to activate the ▲▼ **Cursor**. Move the cursor using F2▲, F3▼. In order to exit, press F4 [Back <].

6

F2 Select **Delete** to erase the slot.

If erased, the following slot numbers are moved forward. For example, after the 60th measurement, if additional measurements are needed, erase the 1st measurement, and the 2nd measurement becomes the 1st measurement, and the 3rd measurement becomes the 2nd measurement. The 60th measurement becomes the 59th measurement and the new, additional measurement is set to the 60th measurement.

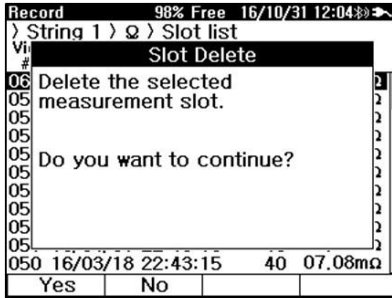

7

F3 Select **Select...** to display the selected slot.

Record 98% Free 16/10/31 12:05:30

> String 1 > Ω > Slot 60

View / delete record.

#	Ω	%	V	% Temp	Time
001	W 07.60	126.7	12.28	102.3	019.7 22:38:51
002	P 07.37	122.8	12.11	100.9	020.4 22:38:58
003	W 07.99	133.2	12.04	100.3	020.1 22:39:05
004	W 08.12	135.3	12.25	102.1	020.3 22:39:12
005	P 07.46	124.3	12.01	100.1	020.3 22:39:19
006	W 07.93	132.2	12.10	100.8	019.6 22:39:26
007	W 08.21	136.8	12.05	100.4	020.2 22:39:33
008	W 08.11	135.2	12.22	101.8	019.8 22:39:40
009	P 07.40	123.3	12.26	102.2	019.7 22:39:47
010	W 08.26	137.7	12.34	102.8	019.9 22:39:54
011	W 07.58	126.3	11.97	099.7	019.7 22:40:01

*Cursor Delete Back

8

Use **F1** to activate the ▲▼ **Cursor**. Move the cursor using **F2▲**, **F3▼**. In order to exit, press **F4 [Back ↵]**.

9

F2 Select **Delete** to erase the recording.

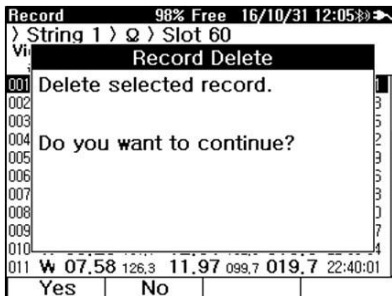

6.4.2 V.A recording

1

MEM

Enter Memory.

2

F2 Select **String**.

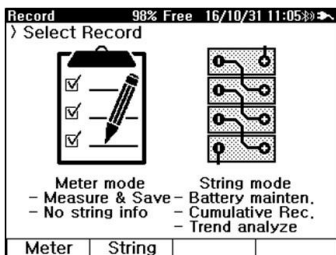

Recording Initial display

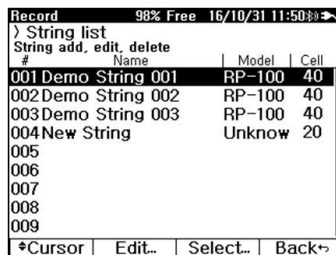

String List

3

Use **F1** to activate the **▲▼ Cursor**. Move the cursor using **F2▲**, **F3▼**. In order to exit, press **F4 [Back ↔]**.

4

F2 Select **Select...**



5

F2 Select the set of measurement data.

6

Use **F1** to activate the **▲▼ Cursor**. Move the cursor using **F2▲**, **F3▼**. In order to exit, press **F4 [Back ↔]**.

F2 Select **Delete** to erase the selected recording.

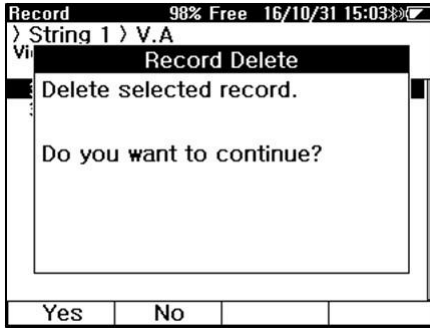

7 Analyzer

The function displays a list of results for a given string. Based on this list, an impedance trend line can be generated, which can suggest service work.



Do not erase the meter's memory. The device has to store historical measurement data in memory in order to perform a clear analysis.

1

MEM

Enter Analyzer to display the string list.



F1 F2

Press ▲ ▼ to move the cursor to the string to be analysed.

F3

Select **Select...**

#	Name	Model	Cell
001	Demo String 001	RP-100	40
002	Demo String 002	RP-100	40
003	Demo String 003	RP-100	40
004	New String	Unknow	20

2

The slot list displays. It is a list of packets within the selected string.

F1 F2

Press ▲ ▼ to move the cursor to the slot to be analysed.



F3

Select **Select...** to select the cell packet.

#	Time	Record	Avg Ω
060	16/08/05 22:43:25	40	07.98mΩ
059	16/07/22 22:43:24	40	07.85mΩ
058	16/07/08 22:43:23	40	07.74mΩ
057	16/06/24 22:43:22	40	07.61mΩ
056	16/06/10 22:43:21	40	07.53mΩ
055	16/05/27 22:43:20	40	07.45mΩ
054	16/05/13 22:43:19	40	07.36mΩ
053	16/04/29 22:43:18	40	07.29mΩ
052	16/04/15 22:43:17	40	07.23mΩ
051	16/04/01 22:43:16	40	07.10mΩ
050	16/03/18 22:43:15	40	07.08mΩ

3

The cell list is ordered by descending impedance value.

F1 F2 Press ▲▼ to select the cell to be checked via the trend curve.



F3 Select Trend...

Analyzer		16/10/31 11:09					
) String 1) Ω) Slot 60							
Select cell for display trend.							
#	Ω	%	V	%	Temp	Time	
025	F	09.25	154.2	11.92	099.3	020.0	22:41:39
016	F	09.10	151.7	11.99	099.9	019.9	22:40:36
020	F	09.08	151.3	12.01	100.1	020.0	22:41:04
019	W	08.91	148.5	12.02	100.2	019.9	22:40:57
022	W	08.73	145.5	12.21	101.7	019.5	22:41:18
038	W	08.60	143.3	12.09	100.7	019.6	22:43:11
023	W	08.58	143.0	12.06	100.5	019.8	22:41:25
026	W	08.55	142.5	12.36	103.0	019.8	22:41:46
037	W	08.44	140.7	12.09	100.7	020.4	22:43:04
040	W	08.43	140.5	12.36	103.0	020.1	22:43:25
033	W	08.31	138.5	12.30	102.5	019.5	22:42:35
							▲ ▼ Trend... Back↵

4

Historical data for the selected cell will appear. Select **Chart...** to display this data as a trend curve.

Analyzer		16/10/31 11:09					
) String 1) Ω) Cell 25							
Display trend of the selected cell.							
#	Ω	%	V	%	Temp	Time	
060	F	09.25	154.2	11.92	099.3	20.0	16/08/05
059	W	08.57	142.8	12.17	101.4	19.5	16/07/22
058	W	08.65	144.2	12.41	103.4	19.9	16/07/08
057	W	08.23	137.2	12.07	100.6	19.6	16/06/24
056	W	08.00	133.3	11.98	099.8	20.1	16/06/10
055	W	08.09	134.8	12.06	100.5	19.5	16/05/27
054	W	08.16	136.0	12.38	103.2	20.0	16/05/13
053	W	07.75	129.2	12.23	101.9	19.8	16/04/29
052	W	07.92	132.0	12.28	102.3	20.4	16/04/15
051	P	07.33	122.2	12.30	102.5	19.9	16/04/01
050	P	07.48	124.7	12.33	102.7	19.8	16/03/18
							▲ ▼ Chart... Back↵

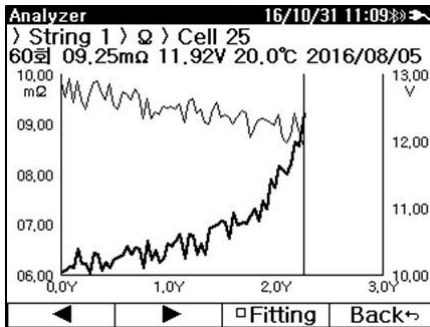

8

Measurement values change over time, as seen in the chart. The bold line represents impedance, and the thin line represents voltage. Press **F1** ◀, **F2** ▶ to move the cursor. The cursor point indicates measurement value and time.

F3

Select **Fitting** to display the trend curve. The line will estimate when the cell impedance will deteriorate (increase) to the Upper level 2 limit.

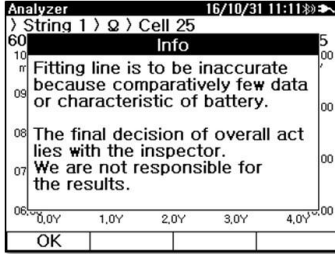



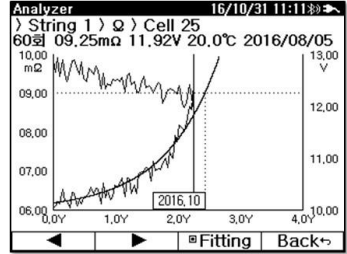



Trend curve information



Trend curve

8 Power supply

The charge level of the rechargeable battery is indicated by the symbol in the upper right corner of the display on a permanent basis.

	Battery charged more than 85%
	Battery charged more than 70%
	Battery charged more than 50%
	Battery charged more than 25%
	Battery fully discharged. After a 30-second warning sounds, the meter shuts down
	Power adapter is connected and charging

- The meter is powered by a lithium-ion battery. Recharging should proceed only using the supplied power adapter.
- Battery charging starts when the power supply is connected. Battery charging from 0% to 100% takes approx. 4 hours. While charging, the meter uses network power instead of the battery. However, using the meter while charging may extend the charging time.

9 Cleaning and maintenance



NOTE!

Use only the maintenance methods specified by the manufacturer in this manual.

The casing of the meter may be cleaned with a soft, damp cloth using all-purpose detergents. Do not use any solvents or cleaning agents which might damage the casing (powders, pastes, etc.).

Clean the probe with water and dry it.

The test leads should be cleaned with water and detergents, and then dried.

The electronic system of the meter does not require maintenance.

10 Storage

In the case of storage of the device, the following recommendations must be observed:

- disconnect all the test leads from the meter,
- clean the meter and all its accessories thoroughly,
- wind the test leads,
- in order to prevent a total discharge of the battery pack in the case of prolonged storage, charge the device **at least once every six months**.

11 Dismantling and utilisation

Worn-out electric and electronic equipment should be gathered selectively, i.e. it must not be placed with waste of another kind.

Worn-out electronic equipment should be sent to a collection point in accordance with the regulations valid in a given region.

Before the equipment is sent to a collection point, do not dismantle any elements.

Observe local regulations concerning disposal of packages, waste batteries and rechargeable batteries.

12 Technical data

12.1 Basic data

- ⇒ The abbreviation "m.v." used in the specification of accuracy denotes a measured value.
- Accuracy is specified for a period of one year after calibration, at 18°C to 28°C with a relative humidity up to 80%. Accuracy specification assumes ambient temperature stable to ±1°C.
- Warm-up time: about 30 minutes.

12.1.1 Internal resistance

Display range	Resolution	Accuracy
3 mΩ	1 μΩ	±(0.8% m.v. + 10 digits)
30 mΩ	10 μΩ	
300 mΩ	100 μΩ	
3 Ω	1 mΩ	
30 Ω	10 mΩ	
300 Ω	100 mΩ	

12.1.2 DC voltage

Display range	Resolution	Accuracy
5 V DC	0.001 V	±(0.5% m.v. + 5 digits)
50 V DC	0.01 V	
500 V DC	0.1 V	

12.1.3 AC voltage

Display range	Resolution	Accuracy
500 V (50/60 Hz)	0.1 V	±(0.75% m.v. + 5 digits)

- Frequency range: 40 Hz...100 Hz

12.1.4 DC current

Display range	Resolution	Accuracy
4 A	0.001 A	±(0.5% m.v. + 5 digits)*
40 A	0.01 A	
400 A	0.1 A	

* Additionally, take into account the accuracy of the current clamp.

12.1.5 AC current

Display range	Resolution	Accuracy
4 A	0.001 A	±(0.75% m.v. + 10 digits)*
40 A	0.01 A	
400 A	0.1 A	

* Additionally, take into account the accuracy of the current clamp.

12.1.6 Temperature

Display range	Resolution	Accuracy
-10°C...100°C	0.1°C	±(1% m.v. + 2 digits)

12.1.7 Ripple voltage

Display range	Resolution	Accuracy
0 V...5 V	0.001 V	±(2.5% m.v. + 10 digits)

- Frequency range: 40 Hz...10 kHz

12.1.8 Measurement current

Measurement range	Measurement current	Measurement current frequency
3 mΩ	100 mA	1 kHz
30 mΩ	100 mA	1 kHz
300 mΩ	10 mA	1 kHz
3 Ω	1 mA	1 kHz
30 Ω	100 μA	1 kHz
300 Ω	100 μA	1 kHz

12.2 Other technical data

- a) type of insulation acc. to EN 61010-1 and EN IEC 61557 double
- b) measurement category acc. to EN IEC 61010-2-030 CAT III 500 V
- c) ingress protection acc. to EN 60529 IP54
- d) power supply: AC charging adapter
- input AC 100 V...240 V, 50 Hz / 60 Hz
 - output DC 12 V 2.5 A
- e) power supply: internal battery
- type Li-ion rechargeable battery pack >5.4 Ah
 - voltage rating 7.4 V
 - charging time 4 h
 - battery life >8 h, 300 charging-discharging cycles
- f) dimensions 232 x 192 x 111 mm
- g) weight 1.4 kg
- h) operating temperature 0°C...+50°C
- i) storage temperature -20°C...+50°C
- j) charging temperature 10°C...+40°C
- k) humidity 10%...85%
- l) display graphical LCD, 320 x 240 px
- m) memory of measurement results
- Impedance (Ω, Volt, Temperature, Time) max. 1000 records (1 slot, max. 512 cell recordings, 60 measurements per string)
 - V.A <V DC, V ripple>, <V DC, A DC>, <V AC, A VC> max. 1000 records (512 recordings per string)
- n) transmission of results Bluetooth
- o) altitude a.s.l. 2000 m
- p) the device meets the requirements of EN 61010-1 IEN 61326-1
 EN 55011/A1:2010 (Class A), EN 61000-3-2, EN 61000-3-3

13 Accessories

The full list of accessories can be found on the manufacturer's website.

13.1 C-130BE current clamp

13.1.1 Basic data

Current range	Accuracy
0...40 A DC	$\pm(1.5\% \text{ m.v.} + 6 \text{ digits})$
0...40 A AC	$\pm(1.5\% \text{ m.v.} + 5 \text{ digits})$

13.1.2 Other technical data

- a) range.....0...40 A
b) ratio.....10 mV/A

14 Manufacturer

The manufacturer of the equipment and provider of service during and past the warranty period:

SONEL S.A.
Wokulskiego 11
58-100 Świdnica
Poland
tel. +48 74 884 10 53 (Customer Service)
e-mail: customerservice@sonel.com
web page: www.sonel.com



NOTE!

Service repairs must be performed solely by the manufacturer.

NOTES

NOTES



SONEL S.A.

Wokulskiego 11
58-100 Świdnica
Poland

Customer Service

tel. +48 74 884 10 53
e-mail: customerservice@sonel.com

www.sonel.com