

METRACAL | MC

Multimeter, Calibrator

3-349-566-03

12/3.19





Scope of Delivery

- 1 Multimeter, calibrator
- 1 KS29 measurement cable set
- 2 Batteries
- 1 Condensed operating instructions *
- 1 DAkkS calibration certificate

* Detailed operating instructions are available for download on the internet at www.gossenmetrawatt.com

Overview of Features included

Functions	Multimeter	Calibrator / Simulator
V AC / Hz TRMS	•	—
V DC	•	•
Hz (V AC)	•	Pulse generator / frequency generator
A AC / Hz TRMS	•	—
A DC	•	Current sensor / current sink
Hz (A AC)	•	—
Resistance Ω	•	•
Continuity 	•	—
Diode ... 6 V 	•	—
Temperature TC	•	•
Temperature RTD	•	•
Capacitance 	•	—
Min-Max / data hold	•	—
16 MBit memory ¹⁾	•	—
Features		
IR Interface	•	
Power pack socket	•	
Protection (housing)		IP 65
Measuring category	300 V CAT II	—

¹⁾ For 46,000 measured values, sampling rate adjustable from 0.1 second to 9 hours

Accessories (sensors, plug inserts, adapters, consumable materials)

The accessories available for your instrument are checked for compliance with currently valid safety regulations at regular intervals, and are amended as required for new applications.

Currently up-to-date accessories which are suitable for your measuring instrument are listed at the following web address along with photo, order number, description and, depending upon the scope of the respective accessory, data sheet and operating instructions:

www.gossenmetrawatt.com

See also section 11 on page 80.

Product Support

Technical queries (use, operation, software registration)

If required please contact:

GMC-I Messtechnik GmbH

Product Support Hotline

Phone: +49 911 8602-0

Fax: +49 911 8602-709

e-mail: support@gossenmetrawatt.com

Software Enabling for METRAwin 10

GMC-I Messtechnik GmbH

Front Office

Phone: +49 911 8602-111

Fax: +49 911 8602-777

e-mail: info@gossenmetrawatt.com

Recalibration Service

Our service center **calibrates** and **recalibrates** (e.g. after one year as part of your test equipment monitoring system, prior to use etc.) all instruments from GMC-I Messtechnik GmbH and other manufacturers, and offers free test equipment management.

Repair and Replacement Parts Service Calibration Center* and Rental Instrument Service

If required please contact:

GMC-I Service GmbH

Service Center

Beuthener Straße 41

90471 Nürnberg · Germany

Phone: +49 911 817718-0

Fax: +49 911 817718-253

e-mail: service@gossenmetrawatt.com

www.gmci-service.com

This address is only valid in Germany. Please contact our representatives or subsidiaries for service in other countries.

* DAkkS Calibration laboratory for measured electrical quantities, D-K-15080-01-01, accredited in accordance with DIN EN ISO/IEC 17025

Accredited measured quantities: direct voltage, direct current values, DC resistance, alternating voltage, alternating current values, AC active power, AC apparent power, DC power, capacitance, frequency and temperature

Competent Partner

GMC-I Messtechnik GmbH is certified in accordance with DIN EN ISO 9001.

Our DAkkS calibration laboratory is accredited by the Deutsche Akkreditierungsstelle GmbH (National accreditation body for the Federal Republic of Germany) in accordance with DIN EN ISO/IEC 17025 under registration number D-K-15080-01-01.

We offer a complete range of expertise in the field of metrology: from **test reports** and **proprietary calibration certificates** right on up to **DAkkS calibration certificates**.

Our spectrum of offerings is rounded out with free test equipment management.

As a full service calibration laboratory, we can calibrate instruments from other manufacturers as well.

Table of Contents

Contents	Page	Contents	Page
1 Safety Features and Precautions	8	5 Measurements	26
1.1 Use for Intended Purpose	10	5.1 Switching from the Calibration Function to the Measuring Function	26
1.2 Meanings of Danger Symbols	11	5.2 Voltage Measurement	27
1.3 Meanings of Acoustic Warning Signals	11	5.2.1 Direct Voltage Measurement, V DC	28
		5.2.2 Alternating Voltage and Frequency Measurement, V AC and Hz	29
2 Operating Overview – Connections, Keys, Rotary Switch, Symbols	12	5.3 Resistance Measurement Ω	30
		5.4 Continuity Test	31
3 Initial Start-Up	16	5.5 Diode Testing with Constant Current of 1 mA	32
3.1 Inserting Batteries or Rechargeable Batteries	16	5.6 Temperature Measurement	33
3.2 Switching the Instrument On	16	5.6.1 Measurement with Thermocouples, Temp TC	33
3.3 Setting the Operating Parameters	16	5.6.2 Measurement with Resistance Thermometers	34
3.4 Switching the Instrument Off	17	5.7 Capacitance Measurement	36
		5.8 Current Measurement	37
4 Control Functions	18	5.8.1 Direct Current Measurement, A DC	38
4.1 Selecting Measuring Functions and Measuring Ranges	18	5.8.2 Alternating Current and Frequency Measurement, Direct Connection, mA AC and Hz	39
4.1.1 Automatic Range Selection	18	5.8.3 Direct Current Measurement with Current Clamp Sensor, mA DC	40
4.1.2 Manual Measuring Range Selection	18	5.8.4 AC Measurement with Current Clamp Sensor, A AC and Hz	41
4.1.3 Quick Measurements	19	5.8.5 Direct and Alternating Current Measurement with Current Clamp Transformer, mA DC, mA AC and Hz	42
4.2 Zero Offset / Relative Measurements	19		
4.3 Display (LCD)	20		
4.3.1 Exceeding the Measuring Range	20		
4.4 Measured Value Storage: DATA (auto-hold / compare)	21		
4.4.1 Saving Minimum and Maximum Values – Min/Max Function	22		
4.5 Measurement Data Recording	23		

Contents	Page	Contents	Page
6 Calibration Functions	44	9 Technical Data	68
6.1 Switching from the Measuring Function to the Calibration Function ...	44	10 Maintenance and Calibration	76
6.2 Voltage Source [V]	45	10.1 Displays – Error Messages	76
6.3 Pulse, Frequency Generator (positive square-wave pulse) [Hz]	46	10.2 Batteries	76
6.4 Resistance Simulation [Ω]	47	10.3 Fuse	77
6.5 Temperature Simulation [$^{\circ}\text{C}$ / $^{\circ}\text{F}$]	48	10.4 Housing Maintenance	78
6.5.1 Temperature Simulation for Resistance Thermometers – RTD Temperature Setting	49	10.5 Return and Environmentally Sound Disposal	78
6.5.2 Temperature Simulation for Thermocouples – TC Temperature Setting	49	10.6 Recalibration	79
6.6 Current Source and Current Sink [mA]	51	10.7 Manufacturer's Guarantee	79
6.6.1 Current Sink – Simulation of a 2-Wire Transmitter	52	11 Accessories	80
6.6.2 Current Source	52	11.1 General	80
6.7 Interval Functions, Ramp Functions	53	11.2 Technical Data for Measurement Cables (scope of delivery: KS29 safety cable set)	80
6.7.1 Interval Sequences – INT Function	53	11.3 NA X-TRA Power Pack (not included)	80
6.7.2 Read-Out a Periodic Ramp – RAMP Function	56	11.4 Interface Accessories (not included)	81
6.7.3 Dual Mode (simultaneous simulation and measurement)	58	12 Keyword Index	82
7 Device and Measuring Parameters	60		
7.1 Paths to the Various Parameters	61		
7.2 List of All Parameters	61		
7.3 Querying Parameters – InFo Menu (as moving letters)	62		
7.4 Entering Parameters – SETUP Menu	62		
7.5 Default Settings	64		
8 Interface Operation	66		
8.1 Activating the Interface	66		
8.2 Configuring Interface Parameters	67		

1 Safety Features and Precautions

You have selected an instrument which provides you with high levels of safety.

This instrument fulfills the requirements of the applicable EU guidelines and national regulations. We confirm this with the CE mark. The relevant declaration of conformity can be obtained from GMC-I Messtechnik GmbH.

The device has been manufactured and tested in accordance with safety regulations IEC 61010–1/DIN EN 61010–1/VDE 0411–1. When used for its intended purpose (see page 11), safety of the operator, as well as that of the instrument, is assured. Their safety is however not guaranteed, if the instrument is used improperly or handled carelessly.

In order to maintain flawless technical safety conditions, and to assure safe use, it is imperative that you read the operating instructions thoroughly and carefully before placing your instrument into service, and that you follow all instructions contained therein.

Measuring Categories and their Significance per IEC 61010-1

CAT	Definition
I	Measurements in electrical circuits which are not directly connected to the mains, <i>e.g. electrical systems in motor vehicles and aircraft, batteries etc.</i>
II	Measurements in electrical circuits which are directly connected to the low-voltage mains <i>via plug, e.g. in household, office and laboratory applications etc.</i>
III	Measurements in building installations: stationary consumers, distributor terminals, devices connected permanently to the distributor

The measuring category and the maximum rated voltage which are printed on the device apply to your measuring instrument, e.g. 300 V CAT II.

Refer to section 11.2 regarding use of the measurement cables.

Observe the following safety precautions:

- The multimeter may not be used in **potentially explosive atmospheres**.
- The multimeter may only be operated by persons who are capable of recognizing **contact hazards** and taking the appropriate safety precautions. Contact hazards according to the standard exist anywhere, where voltages of greater than 33 V RMS or 70 V DC may occur. Avoid working alone when taking measurements which involve contact hazards. Be certain that a second person is present.
- **Maximum permissible voltage** between the voltage measuring sockets or all connector sockets and ground is 300 V for measuring category II.

- **Weak battery**

- If the "weak battery" icon appears in the battery level indicator, it's no longer permissible to perform safety-relevant measurements. Furthermore, compliance with the listed specifications is no longer assured in the case of a weak battery.
- Be prepared for the occurrence of unexpected voltages at devices under test (e.g. defective devices). For example, capacitors may be dangerously charged.
 - Make certain that the measurement cables are in flawless condition, e.g. no damage to insulation, no interruptions in cables or plugs etc.
 - Device functions may not be executed in electrical circuits with corona discharge (high-voltage).
 - Special care is required when measurements are made in HF electrical circuits. Dangerous pulsating voltages may be present.
 - Measurements under moist ambient conditions are not permitted.
 - Be absolutely certain that the measuring ranges are not overloaded beyond their allowable capacities. Limit values are included in section 9, "Technical Data", in the table entitled "Measuring Functions and Measuring Ranges" in the "Overload Capacity" column.
 - **The multimeter may only be operated with installed batteries or rechargeable batteries. Dangerous currents and voltages are otherwise not indicated, and the instrument may be damaged.**
 - The instrument may not be operated if the fuse cover or the battery compartment lid has been removed, or if its housing is open.
- The input for the current measuring range is equipped with a fuse link. Maximum permissible voltage for the measuring circuit (= rated voltage of the fuse) is 400 V. Use specified fuses only (see page 73)! The fuse must have a **breaking capacity of at least 10 kA.**

Special Safety Precautions for the Calibrator

- If necessary, use the multimeter section of the instrument to make sure that no dangerous contact voltages are present in the signal circuits to which the instrument is to be connected.
- In order to prevent damage to the instrument, observe the *maximum* allowable voltage and current values indicated at the jacks.

With the exception of the resistance simulation and mA SINK operating modes, the connected signal circuits should not feed any voltage or current back to the calibrator.

In order to avoid damage to the instrument when interference voltages are applied (within allowable limit values), **the mA SINK and mA SOURCE circuits are equipped with an fuse**, which makes this circuit highly resistive in the event that excessive current should occur in case of a fault for the duration of overloading.



Attention!

If the calibrator is connected with reversed polarity, a high current may occur which trips the integrated fuse.



Note

Please observe the following prior to connecting the DUT:

Switch on the instrument and adjust the correct calibrator function before connecting the DUT. Otherwise, a high current may flow through the DUT for a short while after power-on, thus interfering with the fuse test.

Opening of Equipment / Repair

The equipment may be opened only by authorized service personnel to ensure the safe and correct operation of the equipment and to keep the warranty valid.

Even original spare parts may be installed only by authorized service personnel.

In case the equipment was opened by unauthorized personnel, no warranty regarding personal safety, measurement accuracy, conformity with applicable safety measures or any consequential damage is granted by the manufacturer.

Repair and Parts Replacement

When the instrument is opened, voltage conducting parts may be exposed. The instrument must be disconnected from the measuring circuit before performing repairs or replacing of parts. If repair of a live open instrument is required, it may only be carried out by trained personnel who are familiar with the dangers involved.

Defects and Extraordinary Strains

If it may be assumed that the instrument can no longer be operated safely, it must be removed from service and secured against unintentional use.

Safe operation can no longer be relied upon:

- If the device demonstrates visible damage
- If the instrument no longer functions, or if malfunctioning occurs
- After long periods of storage under unfavorable conditions, e.g. humidity, dust or extreme temperature (see "Ambient Conditions" on page 73).

1.1 Use for Intended Purpose

- The multimeter is a portable device which can be held in the hand during the performance of measurements.
- Only those types of measurements described in section 5 may be performed with the measuring instrument.
- The measuring instrument, including measurement cables and plug-on test probes, may only be utilized within the specified measuring category (see section 9 and the table on page 8 regarding significance).
- Overload limits may not be exceeded. See technical data on section 9 for overload values and overload limits.
- Measurements may only be performed under the specified ambient conditions. See section 9 regarding operating temperature range and relative humidity.
- The measuring instrument may only be used in accordance with the specified degree of protection (IP code) (see section 9).



Warning!

The instrument may not be operated in explosive atmospheres, or connected to intrinsically safe electrical circuits.

1.2 Meanings of Danger Symbols



Warning concerning a source of danger (attention: observe documentation!)

1.3 Meanings of Acoustic Warning Signals



 (2x) **Warning for dangerous voltage at the measurement input: U > 33 V AC or U > 70 V DC (double acoustic signal)**



 **Warning for excessive current in the 300 mA measuring range: > 310 mA (intermittent acoustic signal)**



 **Voltage warning: > 310 V (intermittent acoustic signal)**

2 Operating Overview – Connections, Keys, Rotary Switch, Symbols



- 1 Display (LCD) (see page 13 for significance of symbols)
- 2 **MAN / AUTO** Shift key for manual/automatic measuring range selection
 △ Increase parameter values
Operating mode menu: Selection of individual menu entries against direction of flow
- 3 **ON / OFF | LIGHT** key for switching device and display illumination on and off
- 4 **OUT | ENTER**
 OUT: Switch calibrator output on and off
Operating mode menu: Acknowledge entry (ENTER)
- 5 ▷ Increase measuring range or move decimal point to the right (MAN function)
- 6 **Rotary switch** for measuring functions (white) and calibration functions (red), (see page 13 for significance of symbols)
- 7 DAKkS calibration mark
- 8 Connector jacks for calibrator output
- 9 Connector jacks for measuring and sensing inputs
- 10 **DATA / MIN / MAX**
 Key for freezing, comparing and deleting the measured value, and for the Min-Max function
 ▽ Decrease values
Operating mode menu: Selection of individual menu entries in the direction of flow
- 11 **MEASURE / CAL | SETUP**
 Key for switching between measuring, calibration and menu functions
- 12 **ZERO / SEL | ESC**
 Key for zero balancing and for selecting double functions
Operating mode menu: Exit current menu level and return to a higher level.
 Exit parameters entry function without saving. Pause ramp/interval
- 13 <◁ Decrease measuring range or move decimal point to the left (MAN function)
- 14 Power pack connector jack
- 15 Infrared interface

Symbols Used in the Digital Display

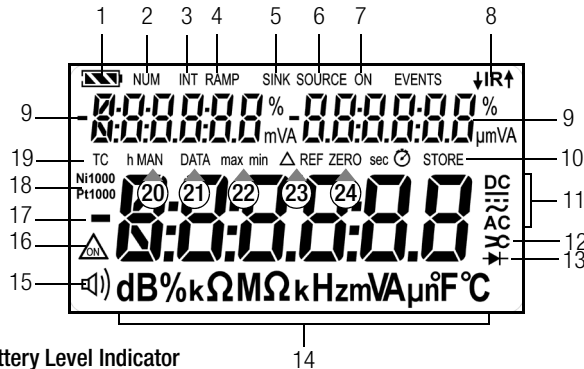



Battery Level Indicator

-  Battery full *
-  Battery OK *
-  Battery weak
-  Battery (almost) dead, U < 2.0 V





* Calibration function: current I_{sink} possible (U > 2.3 V)

Interface Indicator (with rotary switch setting ≠ OFF)

-  Data transmission ↓ to / ↑ from calibrator active
- IR** IR interface in stand-by mode
(ready to receive power-up commands)

- 1 Battery level indicator
- 2 NUM: Numeric entry of the output signal
- 3 INT: Interval sequence active
- 4 RAMP: Ramp function active
- 5 SINK: Current sink active
- 6 SOURCE: Current source active
- 7 ON: Calibrator output active
- 8 IR: infrared interface indicator
- 9 Auxiliary display with decimal point and polarity display
- 10 STORE: memory mode active
- 11 Selected type of current
- 12 Transformation ratio (current clamp factor)
- 13 Diode measurement selected
- 14 Unit of measure
- 15  Continuity test with acoustic signal active
- 16  Continuous operation (automatic shutdown deactivated)
- 17 Digital display with decimal point and polarity display
- 18 RTD: selected nickel or platinum resistance thermometer
- 19 TC: temperature measurement with thermocouple types B through U
- 20 MAN: manual measuring range selection active
- 21 DATA: display memory, "freeze measured value"
- 22 max/min: Min-Max value storage
- 23 Δ : relative measurement with reference to offset
- 24 ZERO: zero balancing active

Symbols Used for Rotary Switch Positions

Rotary Switch	SEL	Display	ZERO	Measuring Function – White Printing
V \equiv	—	mV, V \equiv DC	•	Direct voltage
V~	0/2	mV, V ~ AC TRMS	•	Alternating voltage, AC TRMS, full bandwidth
Hz (V)	1	Hz, kHz ~ AC	—	Voltage frequency, full bandwidth
Ω	0/2	Ω , k Ω , M Ω	•	(DC) resistance
Ω	1	 ζ	—	Continuity test Ω with acoustic signal
	—	 V \equiv DC	—	Diode voltage
Temp. TC	—	°C types B ... U	—	Temperature, type K thermocouple
Temp. RTD	—	°C Pt100/1000 °C Ni100/1000	•	Temperature with resistance thermometer
	—	nF μ F	•	Capacitance
mA \equiv	—	μ A, mA \equiv DC	•	Direct current value
mA~	—	μ A, mA ~ AC TRMS	•	Alternating current amperage, AC TRMS

Rotary Switch	SEL	Display		Calibration Function – Red Printing
V	—	V \equiv DC		Direct voltage simulator
Hz \square \square \square	—	Hz		Pulse / frequency generator
Ω	0/2	ζ		(DC) Resistance simulator
Temp. TC	—	°C types B ... U		Thermocouple simulator
Temp. RTD	—	°C Pt100/1000 °C Ni100/1000		Resistance thermometer simulator
mA	—	mA		Current sink
mA	—	mA		Current sensor

User Interface Symbols in the Following Sections

- ▷ ... ▷ Scroll through main menu
- ▽ ... ▽ Scroll through submenu
- ◁ ▷ Select decimal point
- △ ▽ Increase/decrease value
- b FE* Submenu/parameter (7-segment font)
- Info** Main menu (7-segment font, boldface)

Symbols on the Device



Warning concerning a source of danger (attention: observe documentation!)



Ground

CAT II

Overvoltage category II (see also “Measuring Categories and their Significance per IEC 61010-1” on page 8)



Continuous, doubled or reinforced insulation



EC label of conformity



Position of the infrared interface, window on the top of the instrument



See also section 3.1 regarding location of the power pack adapter socket.



Fuse for current measuring ranges, see section 10.3



This device may not be disposed of with the trash. Further information regarding the WEEE mark can be accessed on the Internet at www.gossenmetrawatt.com by entering the search term WEEE (see also section 10.5).

Calibration mark (blue seal):

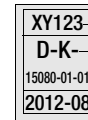

- Serial number
- German Accreditation Body GmbH – Calibration lab
- Registration number
- Date of calibration (year – month)

See also “Recalibration” on page 79.

3 Initial Start-Up

3.1 Inserting Batteries or Rechargeable Batteries

Be certain to refer to section 10.2 regarding correct battery installation.

Momentary battery voltage can be queried in the Info menu (see section 7.3).



Attention!

Disconnect the instrument from the measuring circuit before opening the battery compartment lid in order to replace the batteries.

Operation With Power Pack

(accessory, not included, see section 11.3)

Installed batteries are disconnected electronically if the power pack is used, and need not be removed from the instrument. If rechargeable batteries are used, they must be recharged externally. If the external power supply is switched off, the device is switched to battery operation without interruption.

3.2 Switching the Instrument On

Switching the Instrument On Manually

- ⇨ Press the **ON / OFF | LIGHT** key until the display appears. Power-up is acknowledged with a brief acoustic signal. As long as the key is held depressed, all of the segments at the liquid crystal display (LCD) are illuminated. The LCD is depicted on page 13. The instrument is ready for use as soon as the key is released.

Display Illumination

After the instrument has been switched on, background illumination can be activated by briefly pressing the **ON / OFF | LIGHT** key. Illumination is switched back off by once again pressing the same key, or automatically after approximately 1 minute.

Switching the Instrument On with a PC

The multimeter is switched on after transmission of a data block from the PC, assuming that the “*i r5Eb*” parameter has been set to “*i r0n*” (see section 7.4).

However, we recommend using the power saving mode “*i r0FF*”.



Note

Electrical discharge and high frequency interference may cause incorrect displays to appear, and may disable the measuring or calibrating sequence.

Disconnect the device from the measuring circuit. Switch the instrument off and back on again in order to reset. If the problem persists, briefly dislodge the battery from the connector contacts (see also section 10.2).

3.3 Setting the Operating Parameters

Setting Time and Date

See the “*t i nE*” and “*dAtE*” parameter in section 7.4.

3.4 Switching the Instrument Off

Switching the Instrument Off Manually

⇨ Press the **ON / OFF | LIGHT** key until OFF appears at the display.

Shutdown is acknowledged with a brief acoustic signal.

⇨ Complete shutdown of all functions including the IR interface is accomplished by turning the rotary switch to **OFF**.

In the calibration function, the output can be shut down separately with the **OUT | ENTER** key.

Shutdown is acknowledged with a brief acoustic signal.

Exceptions:

If a dangerous voltage is present at the input, shutdown is blocked and an acoustic signal is generated. The instrument must be disconnected from the measuring cables before being switched off.

Automatic Shutdown – DMM

The instrument is switched off automatically if the measured value remains unchanged for a long period of time (maximum measured value fluctuation of approx. 0.8% of the measuring range per minute, or 1° C or 1° F per minute), and if none of the keys or the rotary switch have been activated before a selected period of time in minutes has elapsed (see “**APoFF**” parameter on page 63).

Shutdown is acknowledged with a brief acoustic signal.

Exceptions:

Transmission and memory mode operation, continuous operation and whenever a dangerous voltage is applied to the input ($U > 33 \text{ V AC}$ or $U > 70 \text{ V DC}$).

Automatic Shutdown – Calibrator

The device is switched off automatically after the selected time, “APoFF” (see page 63), has elapsed. The display is shut down after one additional minute, assuming that neither the rotary switch nor any of the keys are activated.



The display can also be switched off by pressing the **ON / OFF | LIGHT** key.

Automatic shutdown of the outputs is disabled in the continuous operation mode (AP OFF = on).

Disabling Automatic Shutdown

The instrument can be set to continuous operation.

⇨ Simultaneously press the

 and  keys to this end.

or

⇨ Select AP OFF = on in the setup menu (see “**APoFF**” on page 63.)

Continuous operation is indicated at the display with the  symbol.

The “Continuous On” setting can only be canceled by changing the respective parameter, and not by switching the instrument off if automatic shutdown has been deactivated in the setup menu (see “APoFF” on page 63).

4 Control Functions

4.1 Selecting Measuring Functions and Measuring Ranges

The desired measuring function (white symbols) is selected with the rotary switch. Double functions like Hz and continuity testing are selected with the **OUT | ENTER** key.

4.1.1 Automatic Range Selection

The multimeter is equipped with auto-ranging for all measuring functions except for temperature measurement, and diode and continuity testing. Auto-ranging is active as soon as the instrument is switched on. The instrument automatically selects the measuring range which allows for highest possible resolution of the applied quantity. When the instrument is switched to frequency measurement, the previously selected voltage measuring range remains active.

AUTO-Range Function

The multimeter is switched automatically to the next higher range at $\pm(30999 \text{ d} + 1 \text{ d} \rightarrow 3 \text{ 1000 d})$ and to the next lower range at $\pm(2700 \text{ d} - 1 \text{ d} \rightarrow 2699 \text{ d})$.

Exception, capacitance measurement:

The multimeter is switched automatically to the next higher range at $\pm(3099 \text{ d} + 1 \text{ d} \rightarrow 3 \text{ 10 d})$ and to the next lower range at $\pm(270 \text{ d} - 1 \text{ d} \rightarrow 269 \text{ d})$.

4.1.2 Manual Measuring Range Selection

Auto-ranging can be deactivated and measuring ranges can be selected manually in accordance with the following table by pressing the **MAN / AUTO** button.

The desired measuring range can then be selected with the \triangleleft or \triangleright scroll key.

The instrument is automatically returned to range selection when the **MAN / AUTO** key is pressed, the rotary switch is activated or the instrument is switched off and back on again.

Overview: Auto-Ranging and Manual Range Selection

	Function	Display
MAN / AUTO	Manual mode active: Utilized measuring range is fixed	MAN
\triangleleft or \triangleright	Range switching sequence for: V**: 60 mV* \leftrightarrow 300 mV* \leftrightarrow 3 V \leftrightarrow 30 V \leftrightarrow 300 V Hz: 300 Hz \leftrightarrow 3 kHz \leftrightarrow 30 kHz \leftrightarrow 300 kHz Ω**: 300 Ω \leftrightarrow 3 k Ω \leftrightarrow 30 k Ω \leftrightarrow 300 k Ω \leftrightarrow 3 M Ω \leftrightarrow 30 M Ω A**: 300 μ A \leftrightarrow 3 mA \leftrightarrow 30 mA \leftrightarrow 300 mA F: 30 nF \leftrightarrow 300 nF \leftrightarrow 3 μ F \leftrightarrow 30 μ F \leftrightarrow 300 μ F	MAN
MAN / AUTO	Return to automatic measuring range selection	—

* Via manual measuring range selection only

** The momentary measured value is used as a reference point during zero balancing, and is subtracted from future measured values. Maximum correction is 50% of the measuring range. If the measuring range is changed with the help of the MAN key, the ZERO function remains active (at the display and in memory).

Note

Use short or shielded measurement cables in case of high-impedance resistance (3 M Ω or 30 M Ω range).

4.1.3 Quick Measurements

Measurements performed using a suitable fixed measuring range are executed more quickly than those which utilize automatic range selection. Quick measurement is made possible with the following two functions:

- **Manual measuring range selection**, i.e. selection of the measuring range with the best resolution (see section 4.1.2)

or

- With the **DATA function** (see section 4.4). In this way, the appropriate measuring range is selected automatically after the first measurement, and the second measurement is executed more quickly.

The selected measuring range remains active for the subsequent series of measurements with these two functions.

4.2 Zero Offset / Relative Measurements

Zero balancing or a reference value for relative measurements can be stored to memory depending upon deviation from the zero point:

Deviation from zero point – with short-circuited measurement cables for V, Ω , mA, RTD – with open input for capacitance unit of measure F	Display
0 to 200 digits	Δ ZERO
> 200 to 15000 digits	Δ

The relevant reference or correction value is deducted individually for the respective measuring function as an offset from all future measurements and remains in memory until deleted, or until the multimeter is switched off.

Zero balancing and reference value adjustment can be used for auto-ranging, as well as for manual measuring range selection.

Zero Balancing

- ⇨ Plug the measuring cables into the instrument and connect the free ends to each other, except for capacitance measurement in which case the ends of the cables are not connected to each other.
- ⇨ Briefly press the **ZERO / SEL | ESC** key.
The instrument acknowledges zero balancing with an acoustic signal, and the “D ZERO” symbol appears at the LCD. The value measured at the moment the key is pressed serves as a reference value.
- ⇨ Zero balancing can be cleared by once again pressing the **ZERO / SEL | ESC** key.

Note

As a result of TRMS measurement, the multimeter displays a residual value of 1 to 30 digits with short-circuited measurement cables as the zero point for V AC/I AC measurements (non-linearity of the TRMS converter). This has no influence on specified accuracy above 2% of the measuring range (or 3% in the mV range).

4.3 Display (LCD)

4.3.1 Exceeding the Measuring Range

Measured Value, Unit of Measure, Type of Current, Polarity

The measured value appears at the digital display with decimal and plus or minus sign. The selected unit of measure and current type are displayed as well. A minus sign appears to the left of the value during the measurement of zero-frequency quantities, if the plus pole of the measured quantity is applied to the “ \perp ” input.

Overranging

If the upper range limit of 31,000 digits is exceeded “ \overline{OL} ” (overload) appears at the display.

Exceptions: “ \overline{OL} ” appears as of 3100 digits for capacitance measurement, and as of 61,000 digits for diode testing.

4.4 Measured Value Storage: DATA (auto-hold / compare)

An individual measured value can be automatically “frozen” with the DATA function (auto-hold). This is useful, for example, when contacting the measuring points with the test probes requires your full attention. After the measuring signal has been applied and the measured value has settled in accordance with the “condition” listed in the table below, the measured value is frozen in the top left section of the auxiliary display as well as the associated „freeze time“ in the top right section and an acoustic signal is generated. The test probes can now be removed from the measuring points, and the measured value can be read from the digital display. If the measuring signal falls below the value specified in the table, the function is reactivated for storage of the next value.

Measured Value Comparison (DATA Compare)



If the currently frozen value deviates from the first saved value by less than 100 digits, the acoustic signal is generated twice. If deviation is greater than 100 digits, only a brief acoustic signal is generated.

Note

However, when the digital display is “frozen”, the decimal point is fixed as well (fixed measuring range, symbol: MAN). The selected measuring range should not be manually changed as long as the DATA function is active.

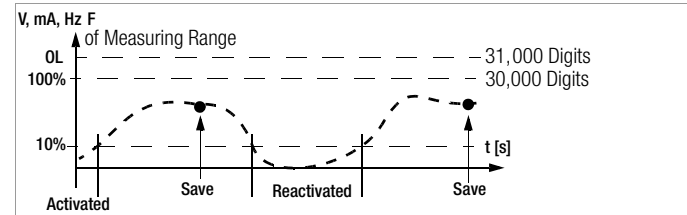
The DATA function is deactivated by pressing and holding the **DATA/MIN/MAX** key (approx. 1 second), when the measuring function is changed or when the instrument is switched off and back on again.



DATA Function	Data/Min/Max Key	Condition		Response from Instrument		
		Measuring Function	Measuring Signal	Auxiliary Display top left	Auxiliary Display top right	Acoustic Signal
Activate	Brief					Once
Save (stabilized measured value)		V, A, F, Hz,	> 10% rdg.	frozen MV is indicated	„Freeze time“ is indicated	Once Twice ²⁾
		RTD TC Ω  →	≠ ΔL			
Reactivate ¹⁾		V, A, F, Hz,	< 10% rdg.	Stored MV		
		RTD TC Ω  →	= ΔL			
Change to Min/Max	Brief	See table, section 4.4.1				
Exit	Long			Is deleted	Is deleted	Twice

¹⁾ Reactivation results from falling short of specified measured value limits.

²⁾ Two acoustic signals are generated the first time a measured value is saved as a reference value. For subsequent data hold, two acoustic signals are only generated if the currently frozen value deviates from the **first** saved value by less than 100 digits.

Key: MV = measured value, MR = measuring range

Example

The voltage measuring range is set manually to 10 V. The first measured value is 5 V and is stored to memory because it is greater than 10% of the measuring range. As soon as the measured value drops to less than 10% of the measuring range, i.e. amounts to less than 1 V which corresponds to removal of the test probes from the measuring point, the instrument is ready to store a new value.

4.4.1 Saving Minimum and Maximum Values – Min/Max Function

Minimum and maximum measured values applied to the measuring instrument's input after the Min/Max function has been activated can be "frozen" at the display. The most important use of this function is the determination of minimum and maximum values during long-term measured value observation.

The Min/Max function can be activated in all measuring functions. Apply the measured quantity to the instrument and set the measuring range with the **MAN / AUTO** key before activating the Min/Max function.

The Min/Max function is deactivated by pressing and holding the **DATA/MIN/MAX** key (approx. 1 second), when the measuring function is changed or when the instrument is switched off and back on again.

Note

As opposed to the DATA function, the Min/Max function can also be used for temperature measurement.

Min-Max Function	Data/Min/Max Key	Min. and Max. Measured Values	Response from Instrument		
			Display Digital Measured Value	Max. Min.	Acoustic Signal
1 Activate and save	1 x brief	Are saved	Current measured value	Min.	Once
2 Save and display	Brief	Storage continues in background, new min. and max. values are displayed together with the point in time of occurrence.	Saved min. value	Min.	Once
	Brief		Saved max. value	Max.	Once
Stop	Long	Are deleted	Current measured value	Is deleted	Twice

4.5 Measurement Data Recording

The multimeter is capable of recording measurement data using an adjustable sampling rate for long periods of time in the form of measurement series. Data are stored to a battery backed memory module, and are retained even after the multimeter is switched off. The system acquires measured values relative to real-time.

Stored measured values can subsequently be read out with the help of **METRAwin 10** software. The only prerequisite is a PC which is connected by means of an interface cable to the USB X-TRA bidirectional interface adapter, which is plugged onto the digital multimeter. See also section 8.

Memory Parameters Overview

Parameter	Page: Header
<i>CLEAR</i>	24: Clear Memory
<i>EMPTY</i>	24: Clear Memory – appears after <i>CLEAR</i>
<i>OCCUP</i>	24: Querying Memory Occupancy
<i>rAtE</i>	62: rAtE – set the sampling rate
<i>StArT</i>	23: Starting Recording via Menu Functions
<i>StoP</i>	24: Ending Recording

The STORE Menu Function

- ⇨ First set the **sampling rate** for memory mode operation (see section 7.4 the *rAtE* parameter), and then start memory mode operation.
- ⇨ Select the desired measuring function and an appropriate measuring range.
- ⇨ Check the battery charge level before starting long-term measurement recordings (see section 7.3). Connect the NA X-TRA power pack if applicable.

Starting Recording via Menu Functions

- ⇨ Switch to the “**StoP**” mode by pressing **MEAS / CAL | SETUP** and select the “**StoP**” menu.



- ⇨ Memory mode operation is started by acknowledging with **OUT | ENTER**. The small STORE segment appears, indicating that the memory mode has been activated. “Store” appears at the digital display, indicating that you’re still in the menu function.
- ⇨ Press **MEAS / CAL | SETUP** in order to return to the measuring function.

During Recording

In order to be able to **observe measured values during recording**, switch to the measuring function by pressing **MEAS / CAL | SETUP**. After pressing **MEAS / CAL | SETUP** once again, the display is returned to the *Info* menu where memory occupancy can be queried with the *OCUP* parameter.

Note

As soon as memory is full, the “Store” segment is cleared from the display.

A new memory block is created when another measuring function is selected with the rotary switch or the **OUT | ENTER** key. Data storage then continues automatically.

Ending Recording

StorE  *StoP*  *StorE*

- ⇨ Press **MEAS / CAL | SETUP** in order to return to the measuring function.
- ⇨ Memory mode operation can also be exited by switching the multimeter off.

Querying Memory Occupancy

Memory occupancy can be queried during recording with the help of the “*Info*” menu (see also section 7.3).

Memory occupancy range: *000.1%* to *099.9%*.



 *Info*  *bAtt: ∇ ... ∇ OCUP %: 0 17.4 %*

Memory occupancy can be queried before recording is started via the “*Info*” menu.

 *Info* ▷ ... ▷ *StorE*  *0 17.4% ▷ StArT*

Clear Memory

This function deletes all measured values from memory! This function cannot be executed during memory mode operation.

 *Info* ▷ ... ▷ *StorE*  *StArT ∇ CLEAR ∇ YES*

 *EMPTy* → *StorE*

5 Measurements

5.1 Switching from the Calibration Function to the Measuring Function

If any calibration function is active, press and hold the **MEASURE / CAL | SETUP** key in order to activate the measuring function.

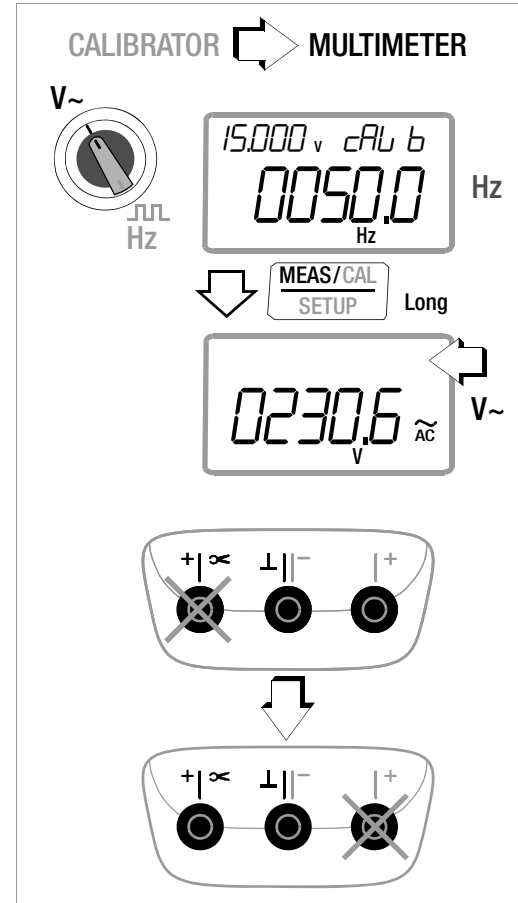

5.2 Voltage Measurement

Notes Regarding Voltage Measurement

- **The multimeter may only be operated with installed batteries or rechargeable batteries. Dangerous voltages are otherwise not indicated, and the instrument may be damaged.**
- The multimeter may only be operated by persons who are capable of recognizing **contact hazards** and taking the appropriate safety precautions. Contact hazards exist anywhere, where voltages of greater than 33 V (RMS) may occur. The test probes may only be only gripped up to the finger guard. Do not touch the metallic test probes under any circumstances.
- Avoid working alone when taking measurements which involve **contact hazards**. Be certain that a second person is present.
- **Maximum permissible voltage** between the connector sockets, (9 and 10) and ground (8) is 300 V for measuring category II.
- Be prepared for the occurrence of unexpected voltages at devices under test (e.g. defective devices). For example, capacitors may be dangerously charged.
- No measurements may be made with this instrument in electrical circuits with corona discharge (high-voltage).
- Special care is required when measurements are made in HF electrical circuits. Dangerous pulsating voltages may be present.
- Be absolutely certain that the measuring ranges are not overloaded beyond their allowable capacities. Limit values are included in section 9, "Technical Data", in the table entitled "Measuring Functions and Measuring Ranges" in the "Overload Capacity" column.

Scope of Functions, Voltage Measurement

Function	
V AC / Hz TRMS	•
V DC	•
Frequency response, V AC	20 kHz

Scope of Functions, Current Measurement via Current Clamp Sensor

Function	
Transformation Ratio \rightarrow C	
A AC \rightarrow C / Hz	
A DC \rightarrow C	
Hz (A AC)	... 10 kHz

5.2.1 Direct Voltage Measurement, V DC



Note

Set the CL, P parameter to **OFF** in the current clamp setup menu. Otherwise all measured values are displayed in mA, corrected by the amount resulting from the selected transformation ratio for an interconnected current clamp sensor.



- ⇒ In accordance with the voltage to be measured, turn the rotary switch to V_{DC} .
- ⇒ Connect the measurement cables as shown. The “ \perp ” connector jack should be grounded.



Note

An intermittent acoustic signal warns the operator if the measured value exceeds the upper range limit in the 300 V range.

Make sure that a current measuring range (“A”) has not been activated, when the multimeter is connected for voltage measurement! If the fuse’s blowing limits are exceeded as a result of operator error, both the operator and the instrument are in danger! With the rotary switch in the V position, the multimeter is always in the 1 V measuring range immediately after it is switched on. As soon as the **MAN / AUTO** key is pressed, and assuming the measured value is less than 310 mV, the multimeter is switched to the mV measuring range.

V_{DC} V_{DC}

020.00 V_{DC}

Measuring ranges:
 V_{DC} : 60mV / 30mV / 3 V / 30 V / 300 V

Warnings regarding dangerous voltages:
 > 33 V AC or > 70 V DC: (2x)
 MB 300 V > 310 V: ...

5.2.2 Alternating Voltage and Frequency Measurement, V AC and Hz

- In accordance with the voltage or frequency to be measured, turn the rotary switch to V~.
- Connect the measurement cables as shown. The “⊥” connector jack should be grounded.

Note: See note regarding the $L P$ parameter in section 5.2.1.

Voltage Measurement

Note

An intermittent acoustic signal warns the operator if the measured value exceeds the upper range limit in the 300 V range.

Make sure that a current measuring range (“mA”) has not been activated, when the multimeter is connected for voltage measurement! If the fuse’s blowing limits are exceeded as a result of operator error, both the operator and the instrument are in danger!

- Repeatedly press the multifunction key **OUT | ENTER** until the unit of measure V appears at the display.

Frequency measurement

- Connect the measured quantity in the same way as for voltage measurement.
- Manually select the measuring range for the voltage amplitude. When the instrument is switched to frequency measurement, the previously selected voltage measuring range remains active.
- Repeatedly press the multifunction key **OUT | ENTER** until the unit of measure Hz appears at the display. Lowest measurable frequencies and maximum allowable voltages are included in section 9, “Technical Data”.

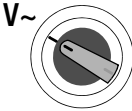







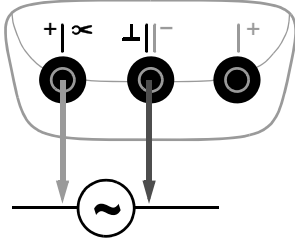











Measuring ranges:
V~: 60mV ... 300 V
max. 300 V (< 10 kHz)
max. 100 V (> 10 kHz)
Hz: 300 Hz ... 300 kHz
 $P_{max} = 3 \times 10^6 \text{ V} \times \text{Hz}$
for $U > 100 \text{ V}$

Warnings regarding dangerous voltage:

> 33 V AC or > 70 V DC:   (2x)
MB 300 V > 310 V:   ...

Voltage Comparator for Displaying Dangerous Voltage

The input signal or measuring signal is checked by a voltage comparator for dangerous peaks.
Where $U > 33 \text{ V AC}$ or $U > 70 \text{ V DC}$, two acoustic signals are generated.

5.3 Resistance Measurement Ω

- Disconnect supply power from the electrical circuit of the device to be measured, and discharge all high-voltage capacitors.
- Make sure that the device under test is voltage-free. Interference voltages distort measurement results! Refer to section 5.2.1 regarding testing for the absence of voltage with the help of the direct voltage measurement.
- Set the rotary switch to " Ω ".
- Connect the device under test as shown.

Note

Use short or shielded measurement cables in the case of high-impedance resistance.

Improving Accuracy by means of Zero Balancing

Cable resistance and contact resistance can be eliminated in all measuring ranges by means of zero balancing (see section 4.2). Maximum correction amounts to 50% of the measuring range.

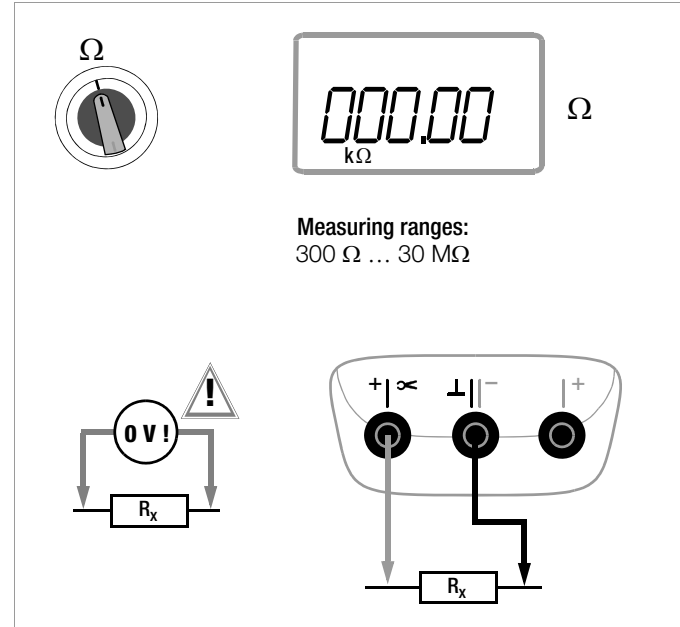

5.4 Continuity Test

- ↗ Disconnect supply power from the electrical circuit of the device to be measured, and discharge all high-voltage capacitors.
- ↗ Make sure that the device under test is voltage-free. Interference voltages distort measurement results!
- ↗ Set the rotary switch to Ω.
- ↗ Press the **SEL** key.
- ↗ Connect the conductor path under test as shown.

Depending upon the selected limit value, the multimeter generates a continuous acoustic signal in the case of continuity or short-circuiting, i.e. at a value of less than the selected limit value. "OL" appears at the display in the case of an open connection. The limit value can be adjusted in the "SEL" menu (see also section 7.4):

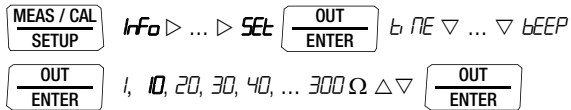

(10 = default setting)

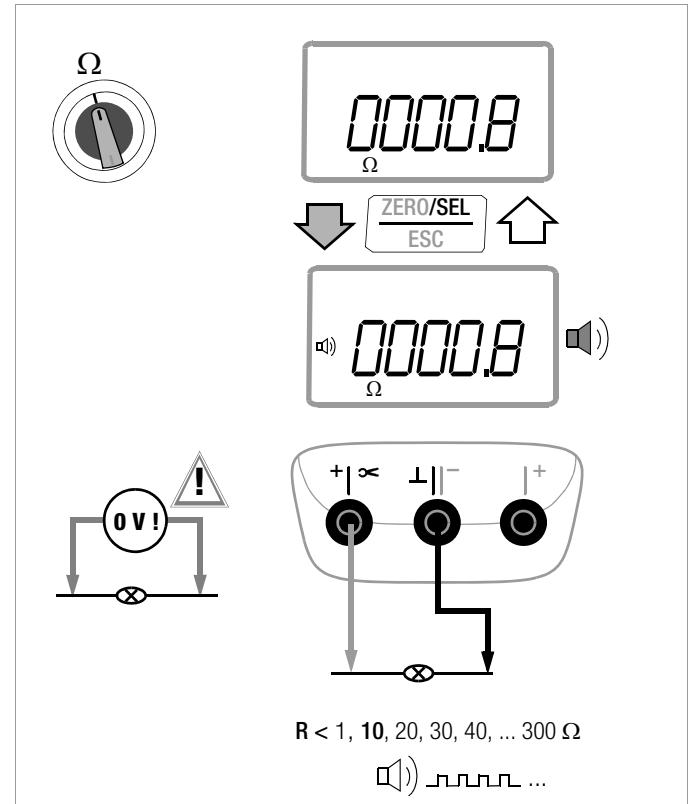

5.5 Diode Testing \rightarrow with Constant Current of 1 mA

- ⇨ Disconnect supply power from the electrical circuit of the device to be measured, and discharge all high-voltage capacitors.
- ⇨ Make sure that the device under test is voltage-free. Interference voltages distort measurement results! Refer to section 5.2.1 regarding testing for the absence of voltage with the help of the direct voltage measurement.
- ⇨ Set the rotary switch to \rightarrow .
- ⇨ Connect the device under test as shown.

Attention!

Observe open-circuit voltage of 7 V during diode testing. Circuits must be laid out accordingly.

Forward Direction and Short-Circuit

The instrument displays forward voltage in volts (display: 4 places). As long as voltage drop does not exceed the maximum display value of 6 V, several series connected components or reference diodes can be tested with a small reference voltage and Z-diodes.

Reverse Direction and Interruption

The measuring instrument indicates overload **OL**.

Note

Resistors and semiconductor paths connected in parallel to the diode distort measurement results!

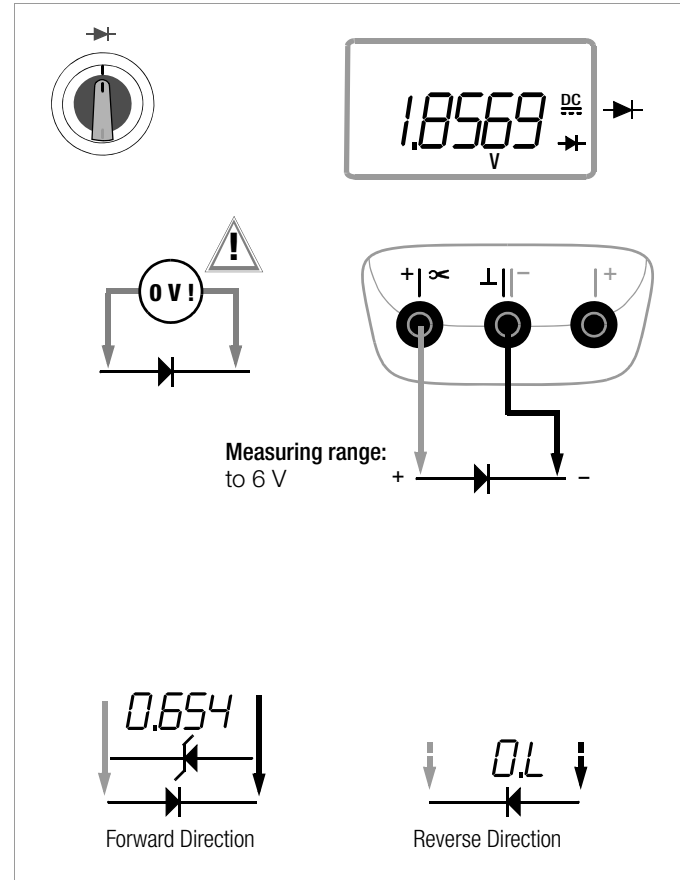

5.6 Temperature Measurement

Temperature measurement is performed with a thermocouple (accessory, not included), which is connected to the voltage input. Alternatively, a resistance thermometer can be used.

Selecting the Unit of Measure for Temperature

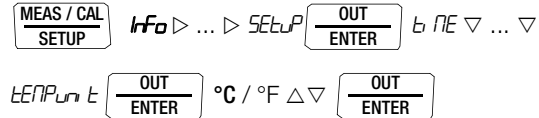

(°C = default setting)

5.6.1 Measurement with Thermocouples, Temp TC

- Set the rotary switch to “Temp_{TC}”.

Note

The last selected temperature sensor remains in memory and is accordingly displayed.

- The reference temperature is measured at the internal reference junction. It is shown in the right-hand auxiliary display or else can be queried (see parameter “TEMP” in section 7.3 regarding querying).

Note

The internal reference temperature (temperature of the internal reference junction) is measured by a temperature sensor inside of the instrument. This may be somewhat above room temperature as a result of internal heat-up, or moving from warmer to colder surroundings or vice versa.

- Connect the sensor to the two accessible jacks. The instrument displays the measured temperature using the selected unit of measure.

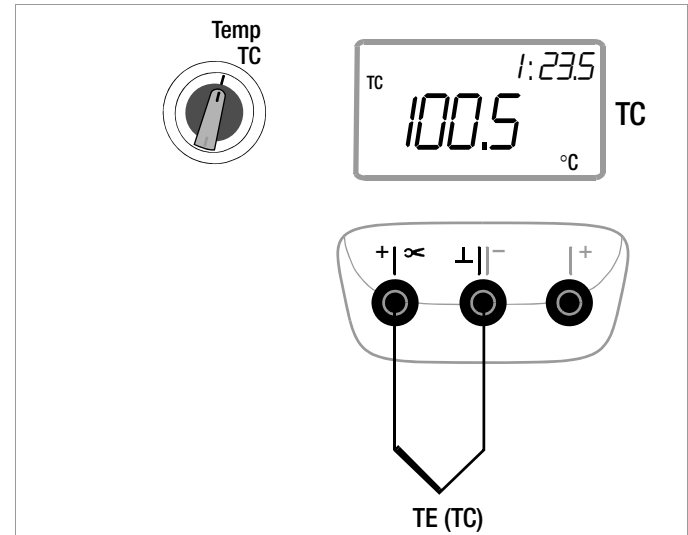

5.6.2 Measurement with Resistance Thermometers

- ⇨ Set the rotary switch to “Temp_{RTD}”.

The last selected resistance thermometer type remains in memory and is accordingly displayed.

There are two different ways to compensate for cable resistance:

Automatic Compensation

- ⇨ Press and hold the **ZERO / SEL | ESC** key.
The “short leads” prompt appears at the display.

If you prefer to enter cable resistance directly, you can skip the following paragraph.

- ⇨ Short circuit the measuring instrument's connector cables.
NEARS LEADS appears at the display. A value of “000.00” settles in. After pressing the **OUT | ENTER** key, automatic compensation of cable resistance is activated for all subsequent measurements. The short-circuit can now be eliminated, and the device is ready for use.

Entering Cable Resistance

- ⇨ Press the **ZERO / SEL | ESC** key once again in the automatic compensation menu.
- ⇨ Enter the known resistance of the connector cables with the scroll keys:
Select the digit to be changed with the \triangleleft \triangleright keys, and change the respectively selected digit with the ∇ \triangle keys. The default value is 0.43 Ω . Values can be selected within a range of 0 to 50 Ω .

- ⇨ Upon pressing the **OUT | ENTER** key, the selected value is activated and the display is returned to the measuring function. Cable resistance is taken into consideration for future measurements, and appears at the top left of the measurement display. Cable resistance remains in memory even after the instrument has been switched off.

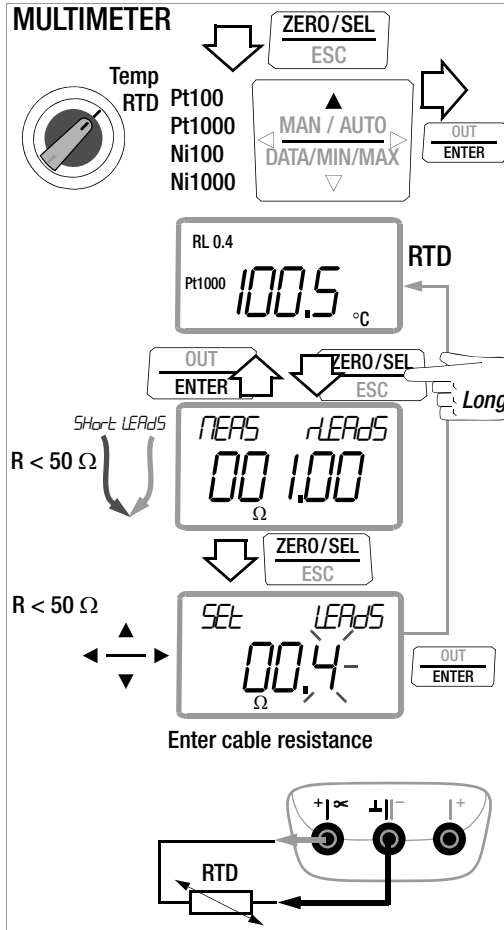

5.7 Capacitance Measurement \rightarrow

- ⇨ Disconnect supply power from the electrical circuit of the device to be measured, and discharge all high-voltage capacitors.
- ⇨ Make sure that the device under test is voltage-free. Capacitors must always be discharged before measurement is performed. Interference voltages distort measurement results! Refer to section 5.2.1 regarding testing for the absence of voltage with the help of the direct voltage measurement.
- ⇨ Set the rotary switch to " \rightarrow ".
- ⇨ Connect the (discharged!) device under test to the sockets with the measurement cables as shown.

Note

The "-" pole of polarized capacitors must be connected to the "⊥" jack. Resistors and semiconductor paths connected in parallel to the capacitor distort measurement results!

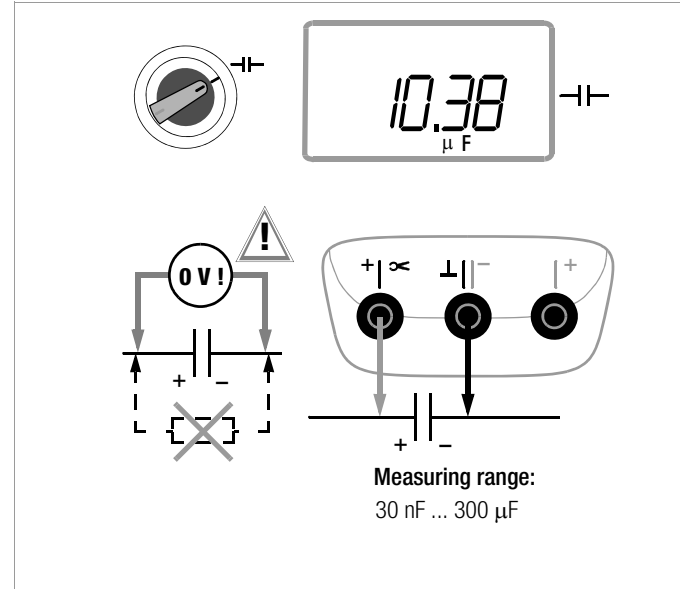

Improving Accuracy by means of Zero Balancing

Cable capacitance can be eliminated in all measuring ranges by means of zero balancing (see section 4.2). Maximum correction amounts to 50% of the measuring range.

5.8 Current Measurement

Notes Regarding Current Measurement

- The multimeter may only be operated with installed batteries or rechargeable batteries. Dangerous currents are otherwise not indicated, and the instrument may be damaged.
- Set up the measuring circuit in a mechanically secure fashion, and secure it against inadvertent breaks. Select conductor cross-sections and lay out connections such that they do not overheat.
- An intermittent acoustic signal (250 ms on, 250 ms off) warns of current which exceeds 310 mA in the 300 mA range.
- The input for the current measuring range is equipped with a fuse link. Maximum permissible voltage for the measuring circuit (= rated voltage of the fuse) is 400 V. Use specified fuses only! The fuse must have a **breaking capacity of at least 10 kA**.
- If the fuse for the active current measuring range blows, “FUSE” appears at the digital display, and an acoustic signal is generated at the same time.
- If a fuse should blow, eliminate the cause of overload before placing the instrument back into service!
- Fuse replacement is described in section 10.3.
- Be absolutely certain that the measuring ranges are not overloaded beyond their allowable capacities. Limit values are included in section 9, “Technical Data” in the table entitled “Measuring Functions and Measuring Ranges” in the “Overload Capacity” column.

Scope of Functions, Current Measurement, Direct Connection

Function		
mA AC / Hz	~	0.3 mA 3/30/300 mA
A DC	≡	0.3 mA 3/30/300 mA
400 V fuse		•

Scope of Functions, Current Measurement via Current Clamp Sensor

Function	
Transformation Ratio \rightarrow C	—
A AC \rightarrow C / Hz	—
A AC+DC \rightarrow C	—
A DC \rightarrow C	—
Hz (A AC)	... 10 kHz

5.8.1 Direct Current Measurement, A DC

- First disconnect supply power from the measuring circuit or the power consumer (1), and discharge any capacitors.
- Set the rotary switch to mA ...
- Safely connect the measuring instrument (without contact resistance) in series to the power consumer (2) as shown.
- Switch supply power to the measuring circuit back on (3).
- Read the display. Make a note of the measured value if the instrument is not being operated in the memory mode or the transmission mode.
- Disconnect supply power from the measuring circuit or the power consumer (1) once again, and discharge any capacitors.
- Remove the test probes from the measuring point and return the measuring circuit to its normal condition.

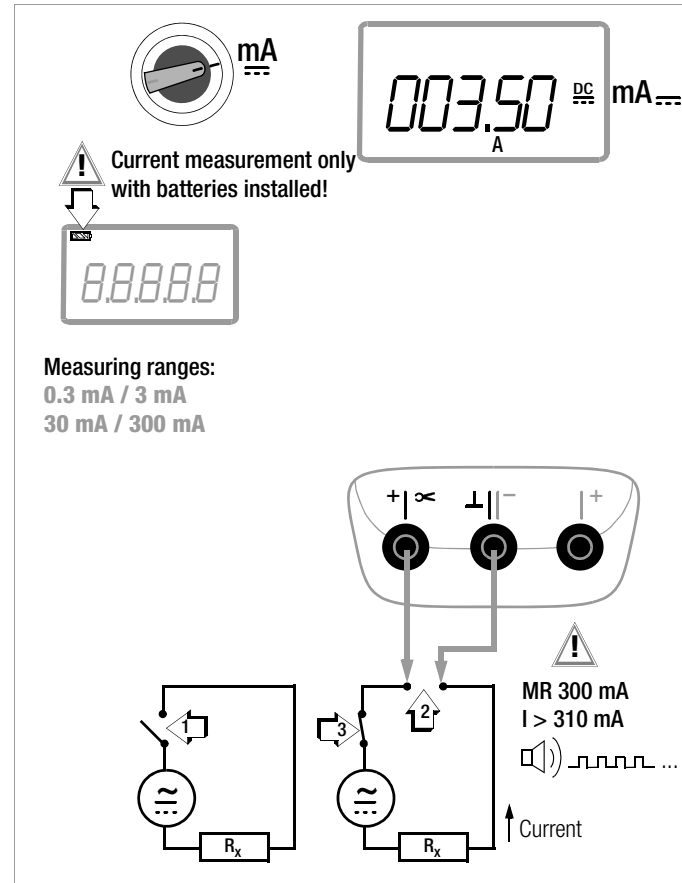

5.8.2 Alternating Current and Frequency Measurement, Direct Connection, mA AC and Hz

- First disconnect supply power from the measuring circuit or the power consumer (1), and discharge any capacitors.
- In accordance with the current or frequency to be measured, turn the rotary switch to A~ or Hz.
- Select the desired measured quantity by briefly pressing the **OUT | ENTER** multifunction key. Each time the key is pressed, AC_{TRMS} and Hz are alternately selected, and switching is acknowledged with an acoustic signal.
- Safely connect the measuring instrument (without contact resistance) in series to the power consumer as shown.
- Switch supply power to the measuring circuit back on (3).
- Read the display. Make a note of the measured value if the instrument is not being operated in the memory mode or the transmission mode.
- Disconnect supply power from the measuring circuit or the power consumer (1) once again, and discharge any capacitors.
- Remove the test probes from the measuring point and return the measuring circuit to its normal condition.

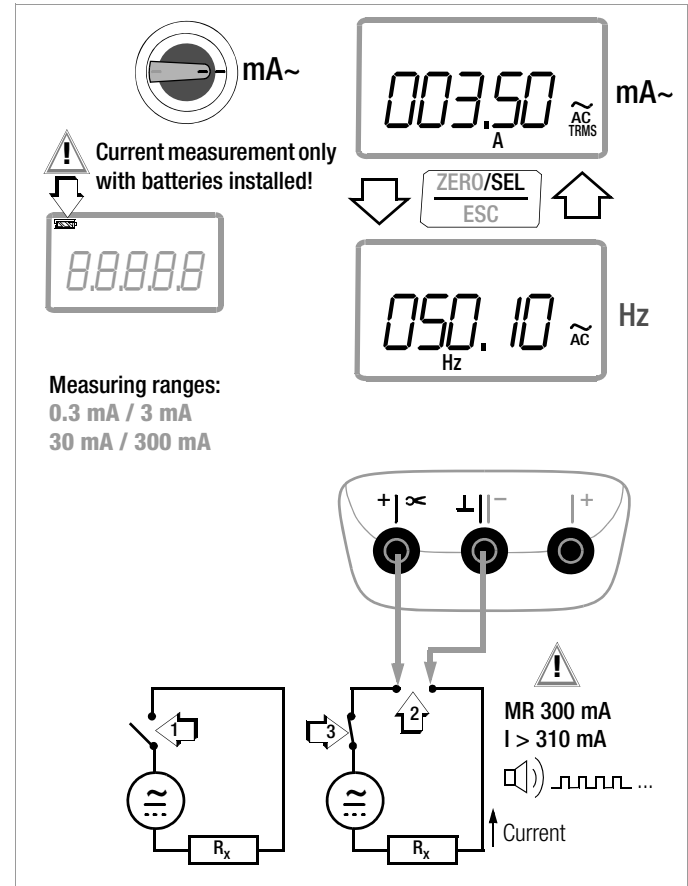

5.8.3 Direct Current Measurement with Current Clamp Sensor, mA DC

Voltage/Current Transformer Output

When a current clamp sensor is connected to the multimeter (∞ V input / ∞ mA input), all current displays appear with the correct value in accordance with the selected transformation ratio. The only prerequisite is that the current sensor is equipped with at least one of the below listed transformation ratios, and that the ratio has been previously selected in the following menu (**CL, P \neq OFF**) (see also section 7.4).

Current Clamp Setup Menu

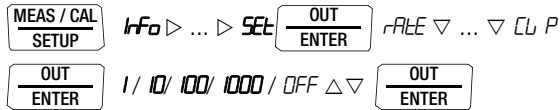

CL, P Transformer Ratios	DMM Measuring Ranges			Clamp Types
	300 mV	3 V	30 V	
1:1 1mV/1mA	300,00 mA	3,0000 A	30,000 A	WZ12C
1:10 1mV/10mA	3,0000 A	30,000 A	300,00 A	WZ12B, Z201A
1:100 1mV/100mA	30,000 A	300,00 A	3000,0 A	Z202A
1:1000 1 mV/1 A	300,00 A	3000,0 A	(3000,0 A)	Z202A, Z203A, WZ12C

The maximum allowable operating voltage is equal to the nominal voltage of the current transformer. When reading the measured value, additional error resulting from the current clamp sensor must also be taken into consideration. (default setting: **OFF**)

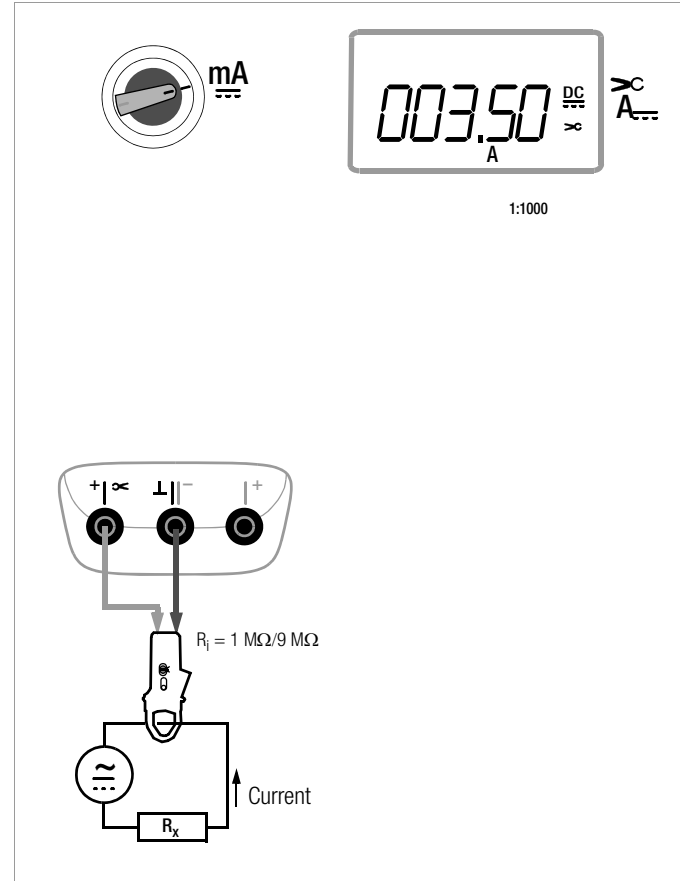

5.8.4 AC Measurement with Current Clamp Sensor, A AC and Hz

Voltage/Current Transformer Output

When a current clamp sensor is connected to the multimeter (∞ V input / ∞ mA input) all current displays appear with the correct value in accordance with the selected transformation ratio. The only prerequisite is that the current sensor is equipped with at least one of the below listed transformation ratios, and that the ratio has been previously selected in the following menu ($CL, P \neq OFF$) (see also section 7.4).

Current Clamp Setup Menu

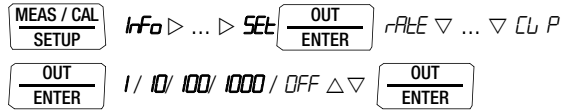

Transformation Ratios CL, P	DMM Measuring Ranges			Clamp Types
	300 mV	3 V	30 V	
1:1 1mV/1mA	300,00 mA	3,0000 A	30,000 A	WZ12C
1:10 1mV/10mA	3,0000 A	30,000 A	300,00 A	WZ12B, Z201A
1:100 1mV/100mA	30,000 A	300,00 A	3000,0 A	Z202A
1:1000 1 mV/1 A	300,00 A	3000,0 A	(30000,0 A)	Z202A, Z203A, WZ12C

The maximum allowable operating voltage is equal to the nominal voltage of the current transformer. When reading the measured value, additional error resulting from the current clamp sensor must also be taken into consideration. (default setting: **OFF**)

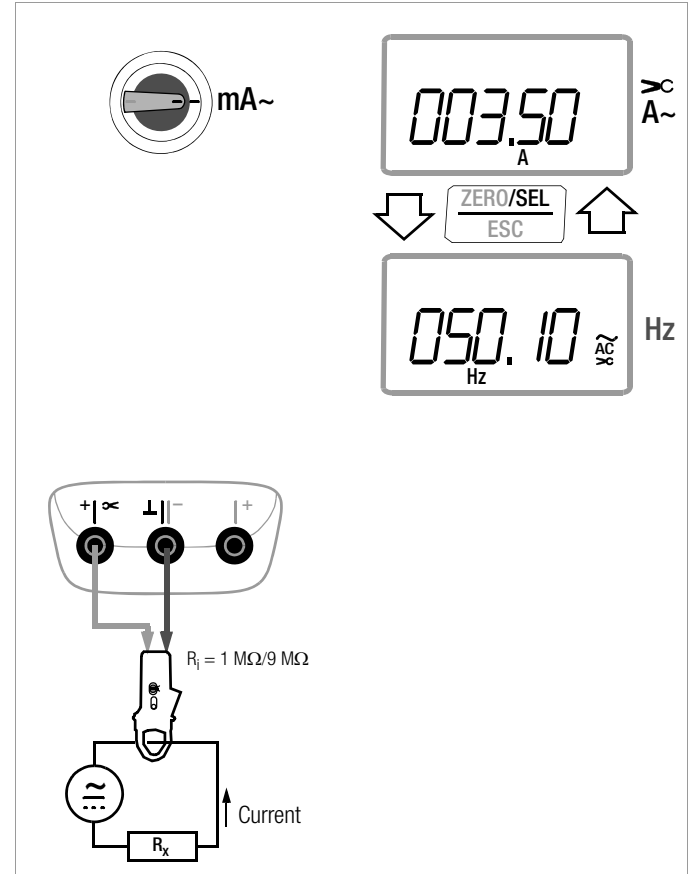

6 Calibration Functions

6.1 Switching from the Measuring Function to the Calibration Function

If any measuring function is active, press and hold the **MEASURE / CAL | SETUP** key in order to switch the calibration function.

The standby function is automatically activated during switch-over.

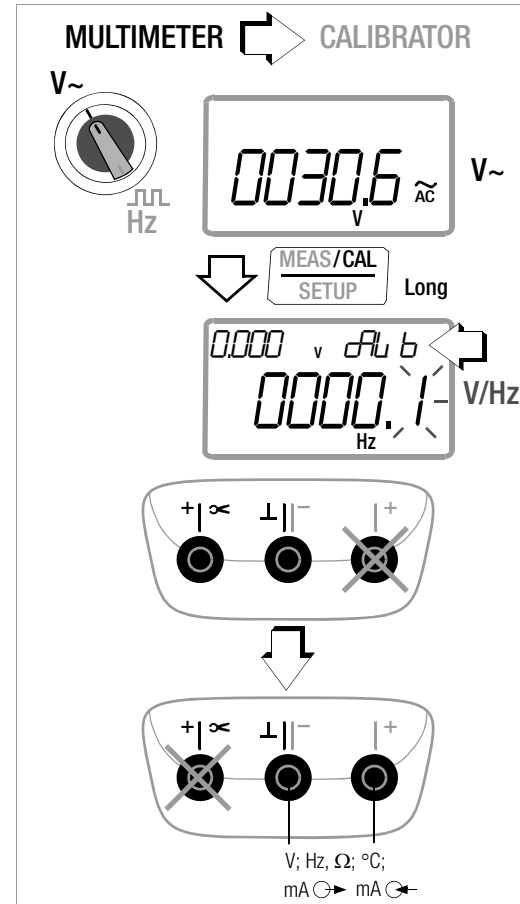

6.2 Voltage Source [V]

Voltages within the following ranges can be simulated:
 0 ... ± 60 mV, 0 ... ± 300 mV, 0 ... 3 V, 0 ... 10 V and 0 ... 15 V.
 Resistance of the connected circuit should not be any less than 1 k Ω .

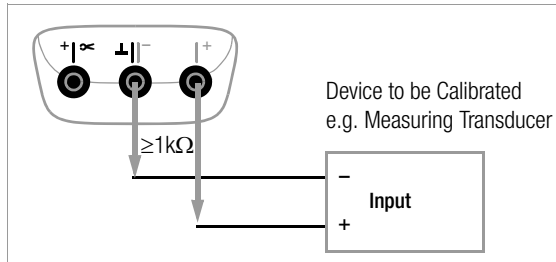

- Select the V calibration function with the **rotary switch**.
- Switch the calibrator on by pressing the **ON / OFF | LIGHT** key. The last selected voltage range is displayed.
- Connect the device to be calibrated with the measurement cable as shown.
- Setting the voltage value:
ON indicates:
Voltage is applied directly to the output!
 Select the digit to be changed with the $\leftarrow \rightarrow$ keys, and change the respectively selected digit with the $\nabla \Delta$ keys.
- Connect the device to be calibrated with the measurement cable as shown.
- The output can be activated with the **OUT | ENTER** key, or deactivated [*5tdb5*] once again.

Selecting a Voltage Range for the Fixed Value Function

- Press the **ZERO / SEL | ESC** key in order to switch to the [*5LEct rAnGE*] menu.
- Select the desired voltage range with the $\nabla \Delta$ keys. Acknowledge your selection with **OUT | ENTER**. The display is switched to the voltage value entry window, but the selected voltage range still appears in the auxiliary display.

Selecting the Voltage Range for the Interval or Ramp Function

- Press the **ZERO / SEL | ESC** key in order to switch to the [*5LEct rAnGE*] menu. Select the desired voltage range with the $\nabla \Delta$ keys.
- Switch to the interval or ramp function menu with the $\leftarrow \rightarrow$ keys (see section 6.7). Start the respective function with **OUT | ENTER**.

Abbreviated Instructions

Select calibration function.

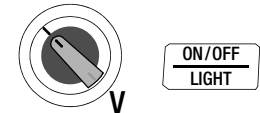

Select voltage range and acknowledge for fixed value function.



Change the fixed value.

000.00V $\leftarrow \rightarrow \Delta \nabla$

(Negative values within a range of ± 60 mV or ± 300 mV can be selected by scrolling with the ∇ key to below the zero point.)

Activate output: **OUT**
ENTER

6.3 Pulse, Frequency Generator (positive square-wave pulse) [Hz]

Voltage and frequency can be set independent of each other for frequency generators.

The output signal is a square wave. Resistance of the connected circuit should not be any less than 1 k Ω .

- Select the $\square\square\square$ /HZ calibration function with the rotary switch.
- Switch the calibrator on by pressing the **ON / OFF | LIGHT** key.
- Connect the device to be calibrated with the measurement cable in the same way as specified for the voltage simulator.

➤ Set the voltage range (300 mV, 3 V, 10 V or 15 V):

Switch to the voltage range menu by pressing the **ZERO / SEL | ESC** key twice [SELEct rAnGE]. Select the desired voltage range with the ∇ Δ keys. Acknowledge your selection with **OUT | ENTER**. The display is switched to the voltage amplitude entry window.

➤ Set voltage amplitude (0 ... 15 V):

Select the digit to be changed with the \triangleleft \triangleright keys, and change the respectively selected digit with the ∇ Δ keys. Acknowledge your selection with **OUT | ENTER**. The display is switched to the frequency entry window, but the selected voltage amplitude still appears in the auxiliary display.

➤ Set frequency (1 ... 2000 Hz):

ON indicates: Voltage is applied directly to the output using the selected frequency!

Select the digit to be changed with the \triangleleft \triangleright keys, and change the respectively selected digit with the ∇ Δ keys.

- The output can be activated with the **OUT | ENTER** key, or deactivated [StdbY] once again.

Note

The following error messages are possible: “**Hi Curr**” (high current – current at overload limit) where $I_{\max.} = 18$ mA, “**OutOL**” and 3 acoustic signals (out of limit – limit value exceeded) where $I > 27$ mA; the simulator is switched off.

Attention!

No external voltage may be applied to the calibrator jacks in this operating mode. The calibrator is protected against brief application of large external voltages with a replaceable fuse in the event of operator error (see section 10.3).

Abbreviated Instructions

Select calibration function.

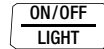

Set the voltage range (starting from frequency display).

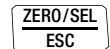
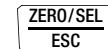

SELEct rAnGE 15V ∇ ... ∇ 60mV

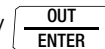

Set voltage amplitude (starting from frequency display).

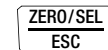

000.00V \triangleleft \triangleright Δ ∇



Set frequency.

0000.0Hz \triangleleft \triangleright Δ ∇

Activate output:



6.4 Resistance Simulation [Ω]

The resistance simulator is capable of simulating resistors using 2-wire connection for the following range: 5 ... 2000 Ω .

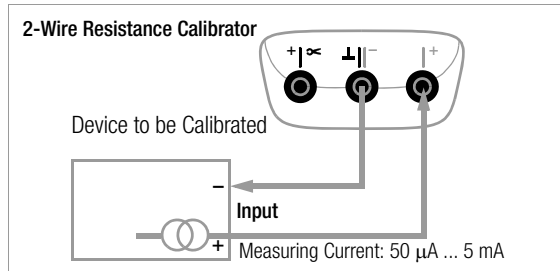

- Select the Ω calibration function with the rotary switch.
- Switch the calibrator on by pressing the **ON / OFF | LIGHT** key.
- Connect the device to be calibrated with the measurement cable as shown.
- **Set the resistance simulation value:**
ON indicates: The output is active!
 Select the digit to be changed with the $\triangleleft \triangleright$ keys, and change the respectively selected digit with the $\nabla \triangle$ keys.
- The output can be activated with the **OUT | ENTER** key, or deactivated [*Stdbb*] once again.

Switching Between the Fixed Value, Interval and Ramp Functions

- Press the **ZERO / SEL | ESC** key in order to switch to the [*SELEct rAnGE*] menu.
- Switch to the interval or ramp function menu with the $\triangleleft \triangleright$ keys. Start the respective function with **OUT | ENTER**.

Abbreviated Instructions

Select the calibration function.

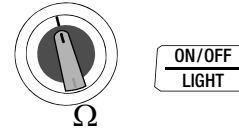

Change the fixed value.

0000.0 Ω $\triangleleft \triangleright \triangle \nabla$

Activate output:



Note

The following error messages are possible: “**Hi Curr**” (high current – current value to high) where $I > 4.5$ mA and “**Lo Curr**” (low current – current too low or reversed polarity) where $I < 40$ μ A (corresponds to unconnected sockets).

No external voltage may be applied to the calibrator jacks in this operating mode.

The calibrator is protected against brief application of a large external voltages with a replaceable fuse in the event of operator error (see section 10.3).

Response time of the calibrator output to the specified resistance value after measuring current is applied is max. 30 ms. Devices under test with non-continuous measuring current (e.g. scanned measuring inputs) result in erroneous measured values, if measurement is started before response time has elapsed. The calibrator cannot be used for devices of this type.

6.5 Temperature Simulation [°C / °F]

The temperature simulator is capable of simulating resistance temperature detectors (RTD) or thermocouples (TC) with specification of the external reference junction temperature.

- ⇨ Select the **Temp RTD** or **Temp TC** calibration function with the rotary switch.
- ⇨ Switch the calibrator on by pressing the **ON / OFF | LIGHT** key. The last selected temperature sensor is displayed.
- ⇨ Connect the device to be calibrated with the measurement cables.

⇨ Set the temperature value:

Simulated resistance or simulated voltage is applied directly to the output!

Select the digit to be changed with the $\triangleleft \triangleright$ keys, and change the respectively selected digit with the $\nabla \triangle$ keys. As an alternative, press and hold the $\nabla \triangle$ keys with the cursor at any entry position until the higher value digits are scrolled through as well.

- ⇨ The output can be activated with the **OUT | ENTER** key, or deactivated [*Stdbb*] once again.

Selecting Resistance Temperature Detector (RTD) or Thermocouple (TC) for Fixed Value, Interval or Ramp Function

- ⇨ Switch to the fixed value, interval or ramp function menu by pressing the **ZERO / SEL | ESC** key.
- ⇨ Select the [*SELEct SENSor*] menu with the $\triangleleft \triangleright$ keys.
- ⇨ Select the desired sensor with the $\nabla \triangle$ keys. Acknowledge your selection with **OUT | ENTER**. The display is switched to the window for temperature value entry, but the selected sensor still appears in the auxiliary display.

The reference temperature is indicated in the auxiliary display.

Parameter Entries for Thermocouple Temperature Simulation

Select unit of measure °C or °F – SET menu.

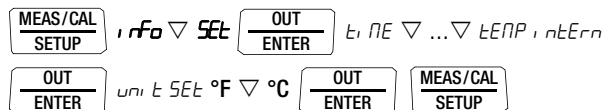

Select internal reference temperature – SET menu.

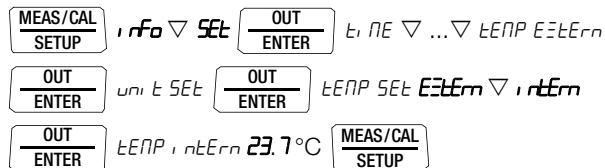

Select and set external reference temperature – SET menu.

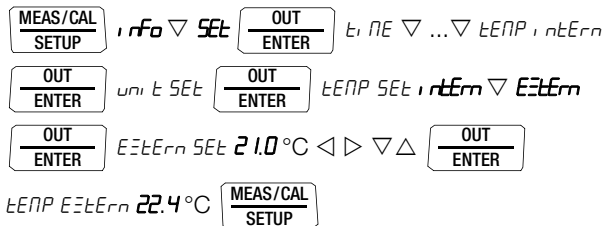

6.5.1 Temperature Simulation for Resistance Thermometers – RTD Temperature Setting

Resistance temperature detectors (types Pt100, Pt1000, Ni100 and Ni1000) are simulated by means of resistance values.

Abbreviated Instructions

Select calibration function.



RTD



Select sensor value and acknowledge for fixed value function.



SELEct SEnSor Pt 100 ▾ ... ▾ n 1000



Set temperature simulator value.

120.0 °C ◀ ▶ △ ▽

Activate output:



Response time of the calibrator output to the specified resistance value after measuring current is applied is max. 30 ms.

Devices under test with non-continuous measuring current (e.g. scanned measuring inputs) result in erroneous measured values, if measurement is started before response time has elapsed. The calibrator cannot be used for devices of this type.

6.5.2 Temperature Simulation for Thermocouples – TC Temperature Setting

Thermocouples (types B, E, J, K, L, N, R, S, T and U) are simulated with voltage. Internal or external temperature compensation is possible.

Abbreviated Instructions

Select calibration function.



TC

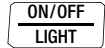

Select sensor value and acknowledge for fixed value function.



SELEct SEnSor b ▾ ... ▾ u



Set temperature simulator value.

120.0 °C ◀ ▶ △ ▽

Select internal or external reference temperature, set external reference temperature (see page 48).

Function Description and Applications

10 different types of thermocouples can be selected, and can be simulated within the temperature ranges specified by IEC/DIN. Selection can be made between an internally measured reference junction temperature, or numeric entry of an external reference junction temperature within a range of -30 to +60° C.

Important Notes Regarding Reference Temperature

Internal reference temperature is continuously measured with an integrated temperature sensor.

The reference temperature is generally measured at the thermocouple connector jack for devices to be calibrated with a thermocouple measuring input.

The two measurements may yield different results, and differences are registered as errors during thermocouple simulation. The following methods help to reduce this error:

- The device to be calibrated is connected to the jacks at the calibrator with equalizing leads for the thermocouple to be simulated.
- The temperature of the thermocouple connector jack at the device to be calibrated is measured with a precision temperature measuring instrument, and the resulting value is entered to the calibrator as a reference temperature. The calibrator and the device to be calibrated are connected with copper wire.

Otherwise, the external reference temperature is entered in all cases where temperature measurement at the device to be calibrated is accomplished by means of a thermostatic reference junction (end of the thermocouple equalizing lead).

No external voltage may be applied to the calibrator jacks in this operating mode.

The calibrator is protected against brief application of large external voltages with a replaceable fuse in the event of operator error (see section 10.3).

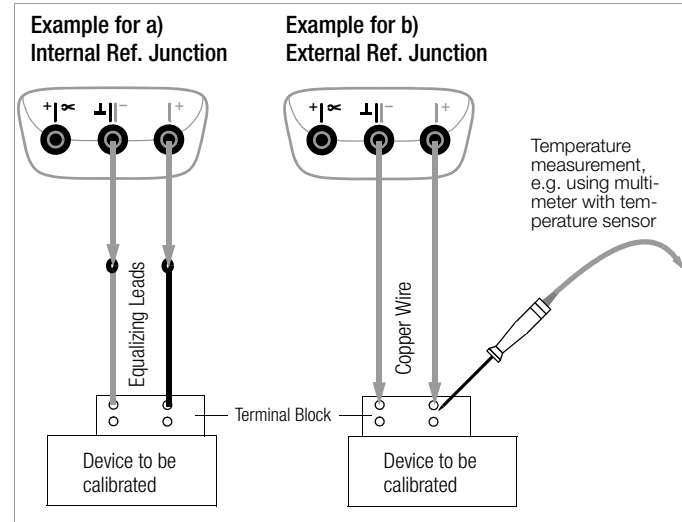

6.6 Current Source and Current Sink [mA]

- ⇨ Select the mA current sink ($\odot\leftarrow$) or mA current source ($\odot\rightarrow$) calibration function with the **rotary switch**.
- ⇨ Switch the calibrator on by pressing the **ON / OFF | LIGHT** key. The last selected current range is displayed.
- ⇨ Connect the device to be calibrated with the measurement cables (see example in section 6.6.1).
- ⇨ **Set the current simulation value:**
SINK ON indicates that the current sink is active!
SOURCE ON indicates that the current source is active!
 Select the digit to be changed with the \triangleleft \triangleright keys, and change the respectively selected digit with the ∇ \triangle keys.
- ⇨ The current sink / current source can be deactivated by pressing the **OUT | ENTER** key [SINK/SOURCE *Stdbb*], or activated once again.

Selecting a Current Range for the Fixed Value Function

- ⇨ Press the **ZERO / SEL | ESC** key in order to switch to the [select range] menu.
- ⇨ Select the desired current range with the ∇ \triangle keys (0 ... 20 mA, 4 ... 20 mA or 0 ... 24 mA).
 Acknowledge your selection with **OUT | ENTER**.
 The display is switched to the current value entry window, but the selected current range still appears in the auxiliary display.

Selecting the Current Range for the Interval or Ramp Function

- ⇨ Press the **ZERO / SEL | ESC** key in order to switch to the [SELEct rAnGE] menu. Select the desired current range with the ∇ \triangle keys.
- ⇨ Switch to the interval or ramp function menu with the \triangleleft \triangleright keys. Start the respective function with **OUT | ENTER**.

Abbreviated Instructions

Select the calibration function.

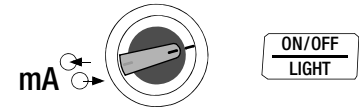

Select current range and acknowledge for fixed value function.



Change the fixed value.

15.00 mA \triangleleft \triangleright \triangle ∇

Activate output:



% read-out (relationship of setting value to simulator's upper range limit)

The display is switched from mA to % by pressing and holding the **OUT | ENTER** key.

6.6.1 Current Sink – Simulation of a 2-Wire Transmitter \odot ←

A current sink (0 ... 24 mA) or current loop load can be simulated with this function. The calibrator regulates the current, which flows via the calibrator jacks from an external power supply, independent of direct voltage applied to the jacks (4 ... 26 V). The calibrator varies internal resistance such that the selected current value is maintained.

Note

The last selected simulation range is saved to memory. Voltage at the calibrator jacks may not exceed 26 V in the current sink operating mode, because thermal overload would otherwise occur and the fuse would blow. **LoVdL** appears at the display if voltage is too low.

Example of a 2-Wire Transmitter Measuring Circuit

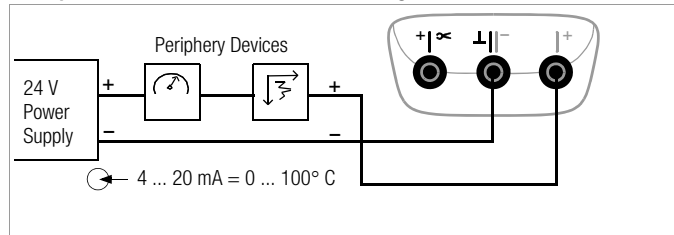

6.6.2 Current Source \odot →

Internal supply power is used to simulate a current source.

Note

The current source's internal control loop is monitored: If voltage drop at the external load (burden) is greater than 20 V, or if the electrical circuit is interrupted, "Hi burd" appears at the display.

No external voltage may be applied to the calibrator jacks in this operating mode.

The calibrator is protected against brief application of large external voltages with a replaceable fuse in the event of operator error (see section 10.3).

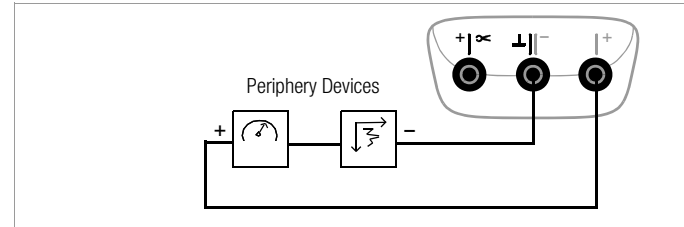

6.7 Interval Functions, Ramp Functions

Two types of setpoint sequences can be generated in order to simulate sensor conditions at the inputs of transducers, transmitters and buffer amplifiers:

- **Interval sequences** (see section 6.7.1)
automatic (periodic) or manually controlled sequences
- or
- **Ramp sequences** (see section 6.7.2)
endless loops (periodic) or one-time only sequences

The above mentioned sequences can be conveniently generated at a PC with the help of METRAWin 90-2 software as an accessory.

6.7.1 Interval Sequences – INT Function

Output ranges are divided into rising or falling interval steps with this function, and the number of interval steps, as well as their duration, can be specified. This function is above all suitable for calibrating analog displays and recorders during one-man operation.

Input parameters for interval sequences:

- All simulation functions except for Hz can be adjusted as output quantities.
- A lower (*SLRrL*) and an upper (*End*) range limit can be selected for each output quantity from within the overall range.
- The number of steps can be set within a range of 1 ... 99.9. The number of steps can be entered as a whole number as well, which is especially practical for analog indicators and recorders with non-standardized scale divisions.
- The interval duration per step (*t1*) can be selected from within a range of 1 second to 60 minutes.

- Step jumps can be executed manually (*Int ModE = MANUAL*) with the Δ and ∇ keys, or automatically (*Int ModE = Auto*) with selectable time per step.

Examples of Automatic Interval Sequences

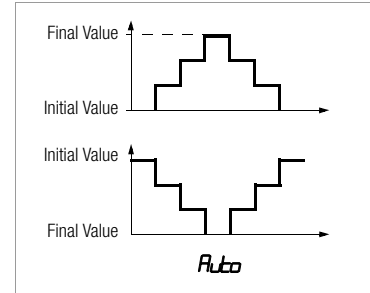

Examples of Manual Interval Sequences

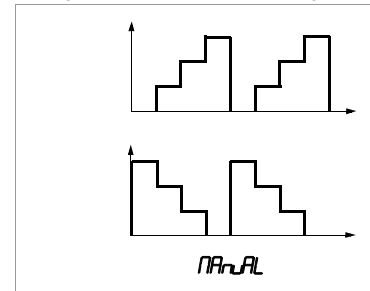

Setting the Interval Parameters

ZERO/SEL ESC	SELECT rANGE 300 mV ... 15 V ∇ \triangleright It	MEAS/CAL SETUP
Initial value:	Int Start 02.000 V \triangleleft \triangleright \triangle ∇	OUT ENTER
Final value:	Int End 10.000 V \triangleleft \triangleright \triangle ∇	OUT ENTER
Steps:	Int STEPS 03.0 \triangleleft \triangleright \triangle ∇	OUT ENTER
Dwell time:	Int t1 00.05 min.s \triangleleft \triangleright \triangle ∇	OUT ENTER
Repetition:	Int Mode Auto ∇ MANUAL	OUT ENTER

(Auto = automatic sequence, MAnUAL = manual sequence)

Manually Controlled Interval Sequence

After entering all parameters for the “manual interval sequence” output function (Int Mode = **MANUAL**) and starting the function with the **OUT** **ENTER** key,

key, the individual steps are triggered with the \triangle and ∇ keys. The relationship between the output signal and each of the key operations is depicted with the help of the following example.

Example of a Manually Controlled Interval Sequence

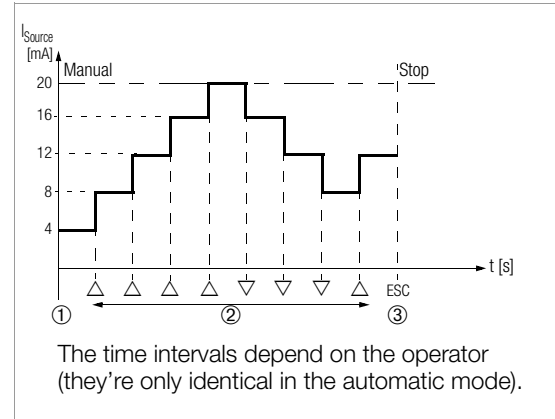

Key

1 When **It rEAdY** appears at the display

Start the sequence by pressing **OUT** **ENTER**

2 The sequence is continued in the corresponding direction by pressing the \triangle or ∇ key.

3 Stop the interval sequence by pressing the **ZERO/SEL** **ESC** key.

Automatic Interval Sequence

Automatic execution of a programmed sequence range is above all advisable if feed to the signal circuit and scanning of the peripheral device under test are physically separated.

After entering all parameters for the “automatic interval sequence” output function (see above) (Int , $EndE = Auto$), the sequence can be started and stopped whenever desired, as well as resumed.

Example of an Automatic Interval Sequence

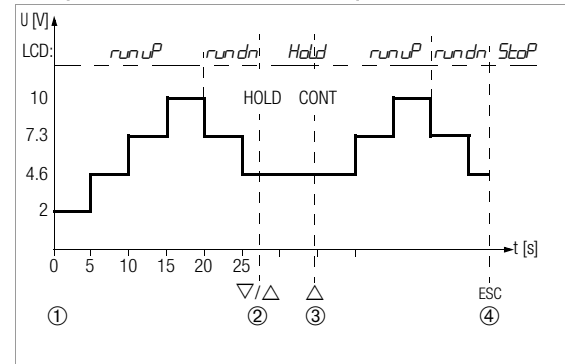

Interval parameters: output quantity: U (range of 0 ... 15 V),
 $Start = 2$ V, $End = 10$ V, number of interval steps = 3, $t_l = 5$ s,
 $EndE = Auto$

Key

- 1 When **Int rEAdy** appears at the display:

Start the sequence by pressing 

- 2 The sequence is stopped by pressing the Δ or the ∇ key. Interval time elapsed thus far is saved as t_x .

- 3 The sequence is resumed by pressing the Δ key, and remaining sequence duration $t_y = t_1 - t_x$.

- 4 Stop the interval sequence by pressing the  key.

6.7.2 Read-Out a Periodic Ramp – RAMP Function

Ramp-type signals can be used to test the dynamic performance of devices to be calibrated, or entire measuring circuits. An example would be performance of a control loop with a setpoint specified via the analog setpoint input at the controller. The instrument can be used to replace costly hardware and software for the set-up of long-term test bays with cyclical time sequences. Parameters for the ramps are depicted below:

- The following functions can be adjusted as output quantities: voltage U, current sink I Sink, current source I Source, resistance R or temperature temp (TC or RTD).
- A lower (*StRrL*) and an upper (*End*) range limit can be selected for each output quantity from within the overall range.
- Rise time t1 and fall time t3 are adjustable from 0 seconds ... 60 minutes.
- Dwell time t2 at the upper and lower range limits is adjustable from 0 seconds ... 60 minutes.
- There are 2 ramp sequences:
 - One-time only (*oneE*): t1, t2, t3
 - Repetition (*rePErE*): t1, t2, t3, t2, t1, t2, t3, ...

Examples of Ramp Sequences

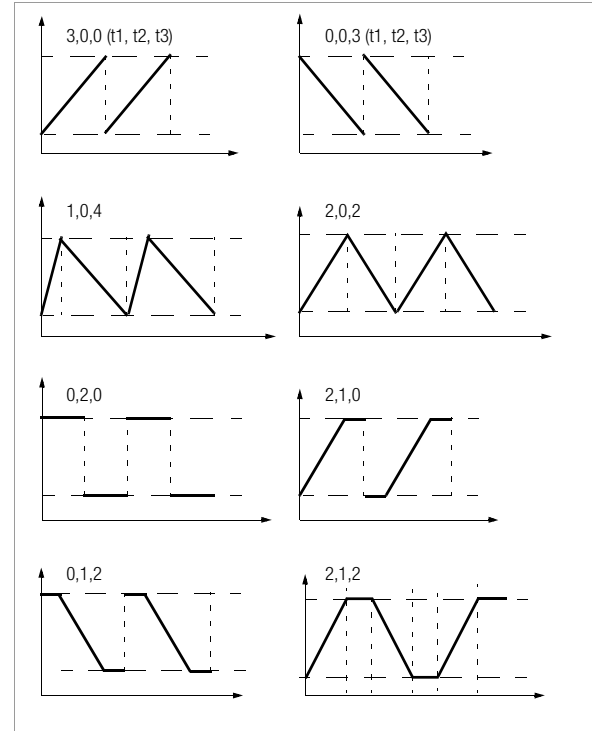

Setting Ramp Parameters

ZERO/SEL / **ESC** SELECT RANGE 300 mV ... 15 V ∇ \triangleright rAMP **MEAS/CAL** / **SETUP**

Initial value: rAMP Start 02.000 V \triangleleft \triangleright \triangle ∇ **OUT** / **ENTER**

Final value: rAMP End 10.000 V \triangleleft \triangleright \triangle ∇ **OUT** / **ENTER**

Rise time: rAMP t1 00.05 min.s \triangleleft \triangleright \triangle ∇ **OUT** / **ENTER**

Dwell time: rAMP t2 00.08 min.s \triangleleft \triangleright \triangle ∇ **OUT** / **ENTER**

Fall time: rAMP t3 00.05 min.s \triangleleft \triangleright \triangle ∇ **OUT** / **ENTER**

Repetition: rAMP Mode REPEAT ∇ onCE **OUT** / **ENTER**
 (rEPEAT = endless loop, onCE = one-time only)

The relationship between the output signal and each of the key operations is depicted with the help of the following example.

Example of a Periodic Ramp Sequence

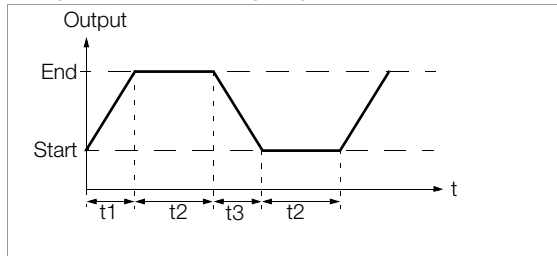

Manually Controlled Ramp Sequence

After entering all parameters, start with **OUT** / **ENTER**.
 Rising or falling ramps can be triggered with the \triangle or ∇ key.

Example of a Periodic Ramp Sequence Controlled by Manual Intervention

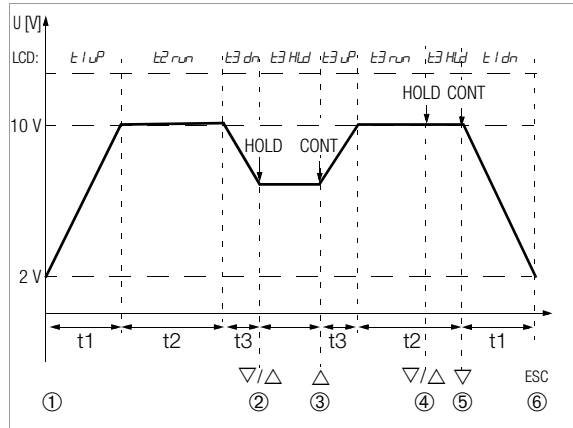

Ramp parameters: output quantity: U (range of 0 ... 15 V),
 $5t_{Art} = 2\text{ V}$, $E_{nd} = 10\text{ V}$, $t_1 = 5\text{ s}$, $t_2 = 8\text{ s}$, $t_3 = 5\text{ s}$
r-EPERL for periodic ramp

Key

1 When *rANP r-ERdY* appears at the display:

Start the sequence by pressing

OUT
ENTER

- 2 Stop the falling ramp within fall time t_3 with the Δ or the ∇ key.
- 3 Start a rising ramp within remaining fall time t_3 with the Δ key.
- 4 Stop the ramp sequence by pressing the Δ or the ∇ key.
- 5 Start a falling ramp with the ∇ key, remaining dwell time t_2 is cleared.
- 6 Stop the ramp sequence by pressing

ZERO/SEL
ESC

.

6.7.3 Dual Mode (simultaneous simulation and measurement)

All simulation functions can be activated and, at the same time, transmitter signal U or I can be measured in the most commonly used measuring ranges (30 V DC or 30 mA DC) in the dual operating mode.

Special case: simulation and measurement of voltage or current without an external circuit. For example, if voltage output needs to be tested, you only need to connect the Calibrator+ and Sense+ sockets to each other, because the Calibrator- and Sense- jacks are connected internally.

Activating the Dual Mode

- \odot Select a simulator function with the rotary switch. The calibration operating mode must be activated (see section 6.1).
- \odot Press and hold the **ZERO / SEL | ESC** key for approximately 2 seconds, and select the U_{dc} or I_{dc} measuring function with the Δ ∇ keys.
- \odot Press the **OUT | ENTER** key in order to acknowledge your selection.
- \odot Depending upon the calibration function, select either the simulator range or the sensor with the **ZERO / SEL | ESC** key.
- \odot Set the simulation value in the main display with the Δ ∇ keys.
- \odot Activate the output by pressing the **OUT | ENTER** key.

The respective measured values appear in the left-hand auxiliary display, and *dUAL* appears to the right of the measured values.

- \odot Exit the “dual mode” function by turning the rotary switch, or by pressing and holding the **ZERO / SEL | ESC** key for approximately 2 seconds, selecting OFF in the menu with the Δ ∇ keys and acknowledging with **OUT | ENTER**.

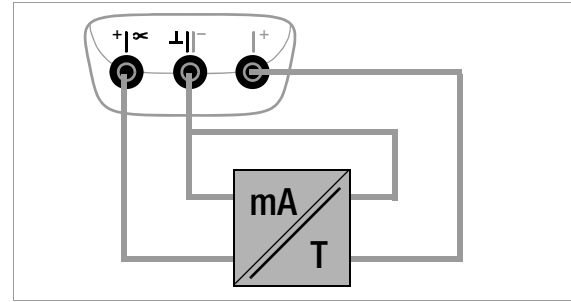
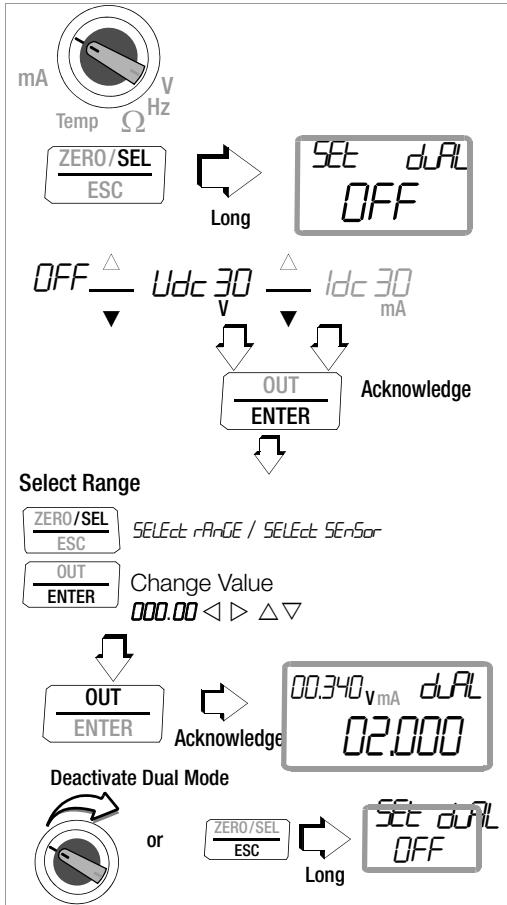

7 Device and Measuring Parameters

The instrument's "**SEL**" mode (menu mode) makes it possible to set operating and measuring parameters, query information and activate the interface.

- ⇨ The menu mode is accessed by pressing the **MEAS / CAL | SETUP** key, assuming that the instrument is switched on and set to "Measure" (measuring mode). "**Info**" appears at the display.
- ⇨ The main menus, i.e. the "**SEtUP**", "**LENt**", "**SEnd**" and "**StorE**" menus, are accessed, and the display is once again returned to "**Info**", by activating the $\triangleleft \triangleright \triangle \nabla$ keys (in any direction).
- ⇨ After selecting the desired main menu, sub-menus are accessed by pressing the **OUT | ENTER** key.
- ⇨ The desired parameter is selected by repeatedly pressing the $\triangle \nabla$ key.
- ⇨ In order to check or change a parameter, acknowledge it with the **OUT | ENTER** key.
- ⇨ The $\triangleleft \triangleright$ keys can be used to position the cursor at the entry position. The desired value is selected with the help of the $\triangle \nabla$ keys.
- ⇨ Changes can only be accepted with the **OUT | ENTER** key.
- ⇨ You can return to the sub-menu without making any changes by pressing the **ZERO / SEL | ESC** key, and to the main menu by pressing the **ZERO / SEL | ESC** key once again etc.
- ⇨ You can switch to the measuring mode from any menu level by pressing the **OUT | ENTER** key.

After repeatedly pressing the **MEAS / CAL | SETUP** key (without first turning the multimeter off), you can return to the last selected menu or parameter from the measuring mode.

Example: Setting Time

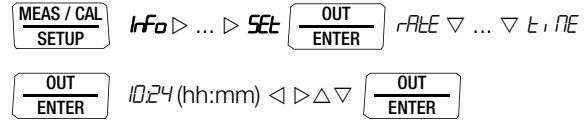

Setting hours and minutes:

- $\triangleleft \triangleright$ Advance to desired entry position.
- $\triangle \nabla$ Change the setting, the entry position blinks. Press and hold the key to change the setting rapidly.
- OUT | ENTER The new time setting is activated after acknowledgment.

7.1 Paths to the Various Parameters

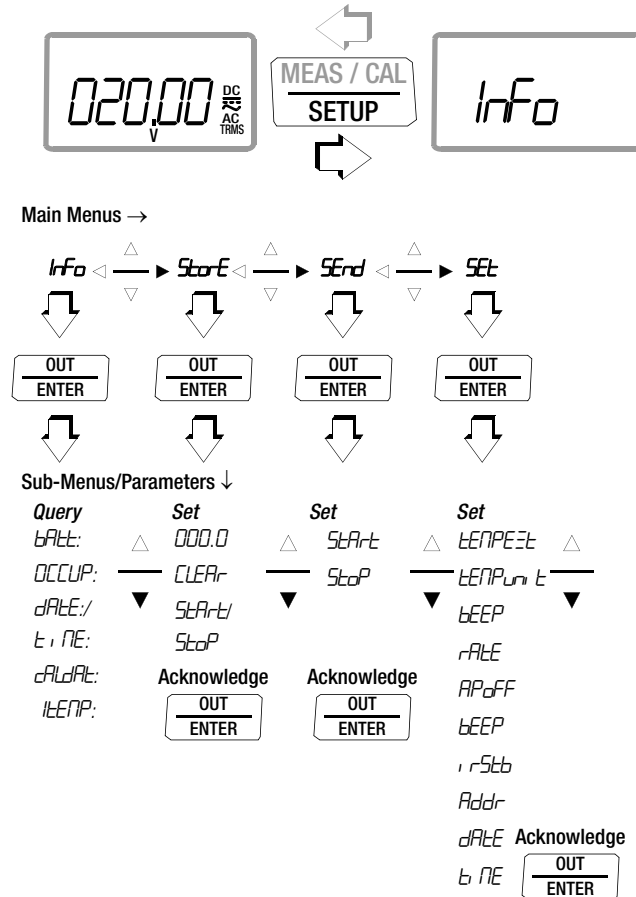



7.2 List of All Parameters

Parameter	Page: Header
<i>0.di SP</i>	62: 0.diSP – show/hide leading zeros
<i>Addr</i>	67: Configuring Interface Parameters
<i>APdFF</i>	63: APoFF – specified time for automatic shutdown and continuous ON
<i>bAtt</i>	62: bAtt – query battery voltage
<i>bEEP</i>	63: bEEP – set limit value for continuity testing
<i>cALdAt</i>	62: cALdAt – query calibration date
<i>CLEAR-</i>	23: Measurement Data Recording
<i>CLAMP</i>	40: Direct Current Measurement with Current Clamp Sensor, mA DC 41: AC Measurement with Current Clamp Sensor, A AC and Hz 42: Direct and Alternating Current Measurement with Current Clamp Trans- former, mA DC, mA AC and Hz
<i>dAtE</i>	62: query date and time 64: dAtE – enter date
<i>EMPTY</i>	23: Measurement Data Recording
<i>Info</i>	62: Querying Parameters – InFo Menu (as moving letters)
<i>rStb</i>	67: Configuring Interface Parameters
<i>ItEMP</i>	62: ItEMP – query reference temperature
<i>OCCUP</i>	23: Measurement Data Recording
<i>rAtE</i>	62: rAtE – set the sampling rate
<i>SEnd</i>	66: Activating the Interface
<i>SEt</i>	62: Entering Parameters – SETUP Menu
<i>StArT</i>	
<i>StoP</i>	23: Measurement Data Recording
<i>StorE</i>	
<i>tEMP</i>	33: Temperature Measurement
<i>t, nE</i>	62: querying date and time, 64: tIME – set time



Device and Measuring Parameters

7.3 Querying Parameters – InFo Menu (as moving letters)

bAtt – query battery voltage

 *Info*  *bAtt: 3.1V.*

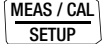
OCCUP – query memory occupancy

 *Info*  *bAtt: ▽ ... ▽ OCCUP:0000%*

querying date and time

 *Info*  *bAtt: ▽ ... ▽ 31.12.2009 (DD.MM.YYYY)*

t, tE: 13:46:56 (hh:mm:ss)

D = day, M = month, Y = year, h = hour, m = minute, s = second

Date and time must be reentered after replacing the batteries.

cALdAt – query calibration date

 *Info*  *bAtt: ▽ cALdAt: 06.07.09 UEr-2.00*

tEMP – query reference temperature

The temperature of the internal reference junction is measured with a temperature sensor in close proximity to the input sockets.

 *Info*  *bAtt: ▽ ... ▽ tEMP:24°C*

7.4 Entering Parameters – SETUP Menu

rAtE – set the sampling rate

The sampling rate specifies the time interval after which the respective measured value is transmitted to the interface, or to measured value memory.

Any one of the following sampling rates can be selected:

[mm:ss.t] 00:00.1, 00:00.2, **00:00.5**, 00:01.0, 00:02.0, 00:05.0
[h:mm:ss.z] (h=hours, m=minutes, s=seconds, z=tenths of a sec.)

0:00:10, 0:00:20, 0:00:30, 0:00:40, 0:00:50, 0:01:00, 0:02:00,
0:05:00, 0:10:00, 0:20:00, 0:30:00, 0:40:00, 0:50:00, 1:00:00,
2:00:00, 3:00:00, 4:00:00, 5:00:00, 6:00:00, 7:00:00, 8:00:00,
9:00:00

Setting the Sampling Rate

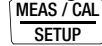
 *Info*  *b, tE ▽ ... ▽ rAtE* 
00:00.1 ... 00:00.5 ... 9:00:00 Δ ▽ 

(00:00.5 = 0.5 s = default value)

0.diSP – show/hide leading zeros

This parameter determines whether or not leading zeros will appear in the measured value display.

 *Info*  *b, tE ▽ ... ▽ 0.di SP* 

00000 : with leading zeros (default value)

00 : leading zeros suppressed

Δ ▽ 

APoFF – specified time for automatic shutdown and continuous ON

DMM

The instrument is switched off automatically if the measured value remains unchanged for a long period of time, and if none of the keys or the rotary switch have been activated before the specified time “APoFF” (entered in minutes) has elapsed.

Calibrator

The instrument switches the output off automatically if none of the keys or the rotary switch have been activated during the time specified in minutes in “APoFF”. The display is also switched off after one additional minute.

Setting APoFF

If the **on** setting is selected, the multimeter is set to continuous operation and **ON** appears in the display to the right of the battery symbol. In this case, the multimeter can only be switched off manually. The “**on**” setting can only be canceled by changing the respective parameter, and not by switching the instrument off.

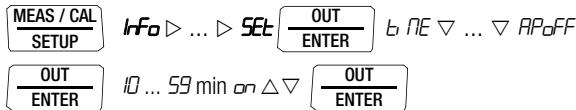

(10 minutes = default setting)

bEEP – set limit value for continuity testing

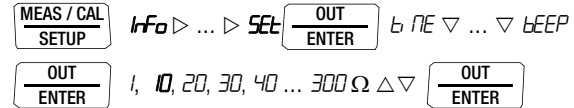

(10 Ω = default setting)

irStb – status of infrared receiver in the stand-by mode

See section 8.2 on page 67 regarding settings.

Addr – set device address

See section 8.2 on page 67.

tiME – set time

Entering the correct time makes it possible to acquire measured values in real-time.

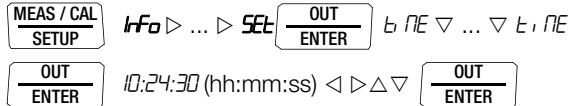

Date and time must be reentered after replacing the batteries.

dAtE – enter date

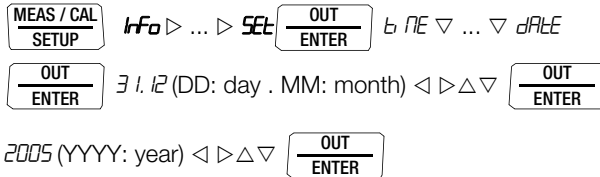

Entering the current date makes it possible to acquire measured values in real-time.



Date and time must be reentered after replacing the batteries.

7.5 Default Settings

Previously entered changes can be undone, and the default settings can be reactivated. This may be advisable under the following circumstances:

- After the occurrence of software or hardware errors
 - If you are under the impression that the multimeter does not work correctly
- ⇒ **Disconnect the device from the measuring circuit.**
- ⇒ Remove the batteries temporarily (see also section 10.2).
- ⇒ Simultaneously press and hold the  and  keys, and connect the battery at the same time.

8 Interface Operation

The **METRACAL MC** is equipped with an infrared interface for communication with the PC. Commands are optically transferred through the instrument housing by means of infrared light to an interface adapter (accessory: **USB X-TRA**), which is plugged onto the **METRACAL MC**. The adapter's USB interface allows connection to the PC via an interface cable.

Commands and parameters can be transmitted from the PC to the **METRACAL MC**. The following functions can be executed:

DMM

- Configuration and read-out of measuring parameters
- Measuring function and measuring range selection
- Start measurement
- Read out stored measured values

Calibrator

- Configuration and read-out of calibration parameters
- Calibration function and measuring range selection
- Start calibration
- Programming of user-specific procedures (interval and ramp functions)

8.1 Activating the Interface

The interface is automatically activated for receiving operation (**METRACAL MC** receives data from the PC) as soon as the interface is addressed by the PC, assuming that the “*r5Eb*” parameter has been set to “on” (see section 8.2), or the instrument is already switched on (the first command wakes up the **METRACAL MC**, but does not yet execute any further commands).

The “continuous transmission” operating mode is selected manually as described below. In this operating mode, the instrument continuously transmits measurement data to the PC via the interface adapter, which can then be displayed with the help of a terminal program.

Starting Continuous Transmission Operation with Menu Functions

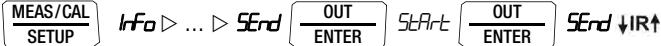

The $\downarrow\text{IR}\uparrow$ symbol blinks at the display indicating interface operation.

Stopping Continuous Transmission Operation with Menu Functions

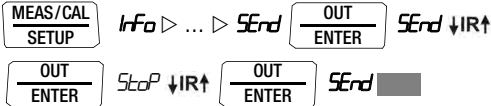

The $\downarrow\text{IR}\uparrow$ symbol is cleared from the display.

Automatic Activation and Deactivation of Transmission Mode Operation





If the sampling rate is 10 seconds or longer, the display is switched off automatically between samples in order to prolong battery service life. The only exception is when the multimeter is set to continuous operation. As soon as an event occurs, the display is automatically switched back on.

8.2 Configuring Interface Parameters

rStb – Status of the Infrared Receiver in the Stand-by Mode

There are two possible switching statuses for the infrared interface when the multimeter is switched off:





- rOn*: IR appears at the display and the infrared interface is active, i.e. signals such as making commands can be received, and power is consumed even though the multimeter is switched off.
- rOff*: IR does not appear at the display and the infrared interface is switched off, signals cannot be received.

 *rFo* ▷ ... ▷ *SEt*  *b rE* ▽ ... ▽ *rStb*
 *rOn / rOff* Δ ▽ 

(*rStb* = *rOff* = default setting)

Addr – Address

If several multimeters are connected to the PC via an interface adapter, a separate address can be assigned to each instrument. Address number 1 should be selected for the first instrument, 2 should be assigned to the second and so forth.

 *rFo* ▷ ... ▷ *SEt*  *b rE* ▽ ... ▽ *Addr*
 *00* ... *01* ... *15* Δ ▽ 

(15 = default setting)

9 Technical Data

Calibrator Section

Calibration Function	Simulation Range	Resolution 30,000 Digits (4 $\frac{3}{4}$ places)		Intrinsic Uncertainty	Overload
Direct Voltage Source			Minimum Load Resistance	$\pm(\% S + mV)$	I_{max}
V	0... ± 60 mV	1 μV	1 k Ω	0.1 + 0.01	18 mA
	0... ± 300 mV	0.01 mV		0.05 + 0.02	
	0 ... 3 V	0.1 mV		0.05 + 0.2	
	0 ... 10 V	1 mV		0.05 + 2	
	0 ... 15 V	1 mV		0.05 + 2	
Pulse / Frequency Generator Duty cycle (pulse-no-pulse ratio): 50%, Amplitude: 10 mV... 15 V			Minimum Load Resistance	$\pm(\% S + Hz)$	I_{max}
Hz	1 Hz ... 2 kHz	0,1 ... 1 Hz	1 k Ω	0.05 + 0.2	18 mA
Current Source			Max. load	$\pm(\% S + \mu A)$	
mA	4 ... 20 mA	1 μA	16 V	0.05 + 2	
	0 ... 20 mA				
	0 ... 24 mA				
Current Sink				$\pm(\% S + \mu A)$	U_{max}
mA	4 ... 20 mA	1 μA	$V_{in} = 4 ... 26 V$	0.05 + 2	26 V
	0 ... 20 mA				
	0 ... 24 mA				
Resistance Simulation			Sensor Current [mA]	$\pm(\% S + \Omega)$	I_{max}
Ω	5...2000 Ω	0.1 Ω	0.05...0.1...4...5	0.05 + 0.2	5 mA

¹⁾ The selection of frequencies as of 29 Hz is only possible within a limited raster.

Simulator for Temperature Sensors (resolution: 0.1 K)

	Sensor Type	Simulation Range in $^{\circ}C$	Simulation Range in $^{\circ}F$	Intrinsic Uncertainty	Overload	
$^{\circ}C / ^{\circ}F$	Resistance Thermometer per IEC 751			$\pm(\% S + K)$	I_{max}	
	Pt100	-200 ... +850	-328...+1562	0.1 + 0.5	5 mA	
	Pt1000	-200 ... +300	-328 ... +572	0.1 + 0.2		
	Resistance Thermometer per DIN 43760			$\pm(\% S + K)$	I_{max}	
	Ni100	-60 ... +180	-76 ... +356	0.1 + 0.5	5 mA	
	Ni1000	-60 ... +180	-76 ... +356	0.1 + 0.2		
	RTD sensor current, 0.05 ... 0.1 ... 4 ... 5 mA					
	Thermocouples per DIN and IEC 584-1				ΔU in mV ²⁾	I_{max}
	K (NiCr/Ni)	-250...+1372	-418...+2501	$\pm(0.05\% Setting + 0.02)$	18 mA	
	J (Fe/CuNi)	-210...+1200	-346...+2192			
	T (Cu/CuNi)	-270...+400	-454...+ 752			
	B (Pt30Rh/Pt6Rh)	+500...+1820	+932...+3308			
	E (NiCr/CuNi)	-270...+1000	-454...+1832			
	R (Pt13Rh/Pt)	-50...+1768	-58...+3214			
	N (NiCrSi-NiSi)	-270...+1300	-454...+2372			
S (Pt10Rh/Pt)	-50...+1768	-58...+3214				
J (Fe/CuNi)	-200...+900	-328...+1652				
U (Cu/CuNi)	-200...+600	-328...+1112				

²⁾ Without internal reference junction, relative to fixed external reference temperature and thermovoltage of the thermocouple, internal reference junction: intrinsic error of 2 K, external reference junction: entry of -30 ... 60 $^{\circ}C$

Key

S = setting value

Multimeter Section

Meas. Function	Measuring Range	Resolution at Upper Range Limit		Input Impedance		Intrinsic Uncertainty at Highest Resolution under Reference Conditions		Overload Capacity ³⁾	
		30000 ¹⁾ (60000)	3100 ¹⁾	DC	AC ²⁾	±(...% rdg. + ... d)	±(...% rdg. + ... d)	Value	Time
						DC	AC ²⁾ ¹⁰⁾		
V	60mV ⁴⁾	1 μV		>20 MΩ	—	0.1 + 10 ⁵⁾	—	300 V DC AC TRMS sine	Cont.
	300 mV	10 μV		>20 MΩ	5 MΩ // < 50 pF	0.08 + 10 ⁵⁾	0.5 + 30 (> 500 d)		
	3 V	100 μV		11 MΩ	5 MΩ // < 50 pF	0.05 + 10	0.2 + 30 (> 100 d)		
	30 V	1 mV		10 MΩ	5 MΩ // < 50 pF	0.05 + 10	0.2 + 30 (> 100 d)		
	300 V	10 mV		10 MΩ	5 MΩ // < 50 pF	0.05 + 10	0.2 + 30 (> 100 d)		
				Voltage drop at approx. range limit					
				DC	AC ²⁾	DC	AC ²⁾ ¹⁰⁾		
mA	300 μA	10 nA		160 mV	160 mV	0.1 + 15	0.8 + 30 (> 100 d)	0.36 A	Cont.
	3 mA	100 nA		160 mV	160 mV	0.05 + 15	0.5 + 30 (> 100 d)		
	30 mA	1 μA		180 mV	180 mV	0.05 + 15	0.5 + 30 (> 100 d)		
	300 mA	10 μA		380 mV	380 mV	0.05 + 15	0.5 + 30 (> 100 d)		
				Open-circuit voltage	Measuring current at range limit	±(...% rdg. + ... d)			
Ω	300 Ω	10mΩ		0.6 V	250 μA	0.1 + 5 ⁵⁾		300 V DC AC TRMS sine	5 minutes
	3 kΩ	0.1 Ω		0.6 V	150 μA	0.1 + 5 ⁵⁾			
	30 kΩ	1 Ω		0.6 V	30 μA	0.1 + 5			
	300 kΩ	10 Ω		0.6 V	3 μA	0.2 + 5			
	3 MΩ	100 Ω		0.6 V	360 nA	0.5 + 10 ¹⁰⁾			
	30 MΩ	1 Ω		0.6 V	100 nA	2 + 10 ¹⁰⁾			
Ω ¹⁰⁾	300 Ω		0.1 Ω	3 V	1 mA	2 + 5			Max. 10 s
→	6 V	1 mV		7 V	Approx. 1 mA	0.5 + 3		300 V	Max. 10 s
				Discharge resistance	U _{0 max}	±(...% rdg. + ... d)			
F	30 nF		10 pF	1 MΩ	3 V	1 + 10 ⁵⁾ ¹⁰⁾		300 V DC AC TRMS sine	5 minutes
	300 nF		100 pF	100 kΩ	3 V	1 + 6 ⁵⁾ ¹⁰⁾			
	3 μF		1 nF	1 kΩ	3 V	1 + 6 ¹⁰⁾			
	30 μF		10 nF	1 kΩ	3 V	1 + 6 ¹⁰⁾			
	300 μF		100 nF	3 kΩ	3 V	5 + 6 ¹⁰⁾			

¹⁾ Display: 3% places for capacitance measurement; a different resolution and sampling rate can be selected in the rATE menu for saving and transmitting measured values.

²⁾ 20 ... 45 ... 65 Hz ... 1 kHz sine, for alternating voltage TRMS_{AC}, measured values < 100 digits are suppressed, see page 71 for influences

³⁾ At 0 ° ... + 40 °C

⁴⁾ Only manually adjustable

⁵⁾ ZERO is displayed for active “zero balancing” function, maximum correction: 50% rdg.

Technical Data

Meas. Function	Measuring Range	Resolution at Upper Range Limit		Input Impedance	Intrinsic Uncertainty at Highest Resolution under Reference Conditions	Overload Capacity ³⁾	
		$\frac{30,000}{(60,000)^{1)}$	3100 ¹⁾			Value	Time
				$f_{\min}^{6)}$	$\pm(\dots\% \text{ rdg.} + \dots \text{ d})$		
Hz	300 Hz	0.01 Hz		1 Hz	0.05 + 5 ^{7) 10)}	300 V	Continuous
	3 kHz	0.1 Hz				300 V	
	30 kHz	1 Hz				200 V	
	300 kHz	10 Hz	10 Hz	20 V			

Meas. Function	Temperature Sensor	Measuring Range	Resolution	Intrinsic Uncertainty at Highest Resolution under Reference Conditions $\pm(\dots\% \text{ rdg.} + \dots \text{ d})^{8)}$	OL Capacity ³⁾	
					Value	Time
°C/°F	Pt100	-200.0 ... -100.0 °C	0.1 K	0.3 + 10	300 V DC RMS sine	5 min
		-100.0 ... +100.0 °C				
		+100.0 ... +850.0 °C				
	Pt1000	-200.0 ... +100.0 °C				
		+100.0 ... +850.0 °C				
	Ni 100	-60.0 ... +180.0 °C				
	Ni 1000	-60.0 ... +180.0 °C				
	K (NiCr-Ni)	-250.0... +1372.0 °C		0.2 + 10 ⁹⁾		
	J (Fe-CuNi)	-210.0... +1200.0 °C				
	T (Cu-CuNi)	-270.0... +400.0 °C				
	B (Pt30Rh/Pt6Rh)	+500.0... +1820.0 °C				
	E (NiCr/CuNi)	-270.0... +1000.0 °C				
	R (Pt13Rh/Pt)	-50.0... +1768.0 °C				
	N (NiCrSi-NiSi)	-270.0... +1300.0 °C				
	S (Pt10Rh/Pt)	-50.0... +1768.0 °C				
J (Fe/CuNi)	-200.0... +900.0 °C					
U (Cu/CuNi)	-200.0... +600.0 °C					

- 1) Display: 3¼ places for capacitance measurement; a different resolution and sampling rate can be selected in the rAtE menu for saving and transmitting measured values.
- 3) At 0 ° ... + 40 °C
- 6) Lowest measurable frequency for sinusoidal measuring signals symmetrical to the zero point
- 7) Range 300 mV~: $U_E \geq 40\%$ of upper range limit
3/30/300 V~: $U_E \geq 10\%$ of upper range limit
For voltage > 100 V: power limiting: $6 \cdot 10^6 \text{ V} \cdot \text{Hz}$
- 8) Plus sensor deviation
- 9) Without integrated reference junction;
with internal reference temperature plus error $\pm 2 \text{ K}$
- 10) The limits only apply for battery operation

Key

d = digit MR = measuring range rdg. = reading (measured value)

Influencing Quantities and Influence Error

Influencing Quantity	Sphere of Influence	Measured Quantity / Measuring range ¹⁾	Influence Error ± (... % rdg. + d)/10 K	
Temperature	0 ... +21 °C and +25...+40 °C	V DC, °C (TC)	0.1 + 10	
		V AC	0.5 + 10	
		3/30 mA DC	0.1 + 10	
		3/30 mA AC	0.5 + 10	
		300 mA DC, AC	0.5 + 10	
		300Ω/3/30/300 kΩ 2L	0.2 + 10	
		3 MΩ 2L	0.5 + 10	
		30 MΩ 2L	1 + 10	
		30/300 nF/3/30/300 μF	0.5 + 10	
		Hz	0.1 + 10	
		°C (RTD)	0.2 + 10	
		Simulator quantity		
		mV/V, °C (TC)	0.1 + 10	
		Ω, °C (RTD)	0.2 + 10	
mA source	0.1 + 10			
mA sink	0.1 + 10			

¹ With zero balancing

Influencing Quantity	Frequency	Measured Qty. / Meas. Range	Influence Error ²⁾ ± (... % rdg. + d)
Frequency V _{AC}	> 20 Hz ... 45 Hz	300.00 mV	2 + 30
	> 65 Hz ... 1 kHz	...	
	> 1 kHz ... 20 kHz	300.0 V	3 + 30

Influencing Quantity	Frequency	Measured Qty. / Meas. Range	Influence Error ²⁾ ± (... % rdg. + ... d)
Frequency I _{AC}	> 20 Hz ... 45 Hz	0.3 mA 3 mA	2 + 30
	> 65 Hz ... 10 kHz	30 mA 300 mA	3 + 30

Influencing Quantity	Sphere of Influence	Measured Quantity / Measuring Range	Influence Error ²⁾
Measured Quantity Waveform	Crest Factor CF	V AC, A AC	1 ... 2
			2 ... 4
			4 ... 5
	<p>Allowable crest factor CF of the periodic quantity to be measured is dependent upon the displayed value:</p> <p>Voltage and Current Measurement</p>		

Influencing Quantity	Sphere of Influence	Measured Quantity / Measuring Range	Influence Error
Relative Humidity	75%	V, A, Ω F, Hz °C	1 x intrinsic uncertainty
	3 days		
	Instrument off		

²⁾ Specified error valid as of display values of 10% of the measuring range

Influencing Quantity	Sphere of Influence	Measuring Range	Attenuation ±dB
Common mode interference voltage	Interference quantity max. 250 V ~	V =	> 90 dB
	Interference quantity max. 250 V ~ 50 Hz, 60 Hz sine	300 mV ... 30 V ~	> 80 dB
		300 V ~	> 70 dB
Series-mode interference voltage	Interference quantity V ~, respective nominal value of the measuring range, max. 250 V ~ , 50 Hz, 60 Hz, sine	V =	> 60 dB
	Interference quantity max. 250 V —	V ~	> 60 dB

Real-Time Clock

Resolution	0.1 s
Accuracy	±1 minute per month
Temp. Influence	50 ppm/K

Reference Conditions

Ambient temperature	+23 °C ±2 K
Relative humidity	40 ... 60%
Meas. quantity frequency	45 ... 65 Hz
Meas. quantity waveform	Sinusoidal, deviation between RMS and rectified value < 0.1%
Battery Voltage	3.0 V ±0.1 V

Response Time (multimeter functions)

Response Time (after manual range selection)

Measured Quantity / Measuring Range	Digital Display Response Time	Measured Quantity Jump Function
V DC, V AC A DC, A AC	1.5 s	From 0 to 80% of upper range limit value
300 Ω ... 3 MΩ	2 s	From ∞ to 50% of upper range limit value
30 MΩ	5 s	
Continuity	< 50 ms	
→	1.5 s	
°C Pt100	Max. 3 s	From 0 to 50% of upper range limit value
3 nF ... 30 μF	Max. 2 s	
>10 Hz	Max. 1.5 s	

Display

LCD panel (65 x 35 mm) with display of up to 3 measured values, unit of measure, type of current and various special functions.

Display / char. height 7-segment characters

Main display: 12 mm

Auxiliary displays: 7 mm

Number of places 4½-places, ≅ 30999 steps

Overflow display "OL" or "-OL" appears

Polarity display "—" sign is displayed if plus pole is connected to "∧"

LCD test

All display segments available during operation of the **METRACAL MC** are activated after the instrument is switched on.

Power Supply

Battery 2 ea. 1.5 V mignon cell (AA), alkaline manganese per IEC LR6 or equivalent rechargeable battery

Service life With alkaline manganese (2600 mAh)

Measuring Function	Current	Service life
V, Hz, mA, Ω ₂ , F, °C	31 mA	70 h
Standby (MEM + clock)	350 µA	Approx. 1 year
Calibration Function	Service life	
mV, thermocouple	80 mA	25 h
15 V	200 mA	10 h
Ω, RTD	130 mA	15 h
Sink, 20 mA (25 V)	300 mA	5 h
Source, 20 mA max. load < 5V	230 mA	10 h

If voltage drops below 2.0 V, the instrument is switched off automatically.

Battery test Battery capacity display with battery symbol in 4 segments: “”. Querying of momentary battery voltage via menu function.

Mains Power With NA X-TRA power pack

Power saving circuit

The device is switched off automatically if the measured value remains unchanged for a long period of time, and if none of the controls are activated before a selected period of time in minutes elapses. In the case of the simulator, the output is switched off first, followed by the display one minute later, if no controls have been activated (**AP oFF = ON**). Shutdown can be disabled.

Fuses

Fuse links **DMM** (mA current measuring ranges):
F2: FF0.63A/400V, 5 mm x 20 mm, breaking capacity: ≥ 10 kA at 400 V AC (Article number: Z109M)
Calibrator:
F1: FF0.16A/400V, 5 mm x 20 mm, breaking capacity: ≥ 10 kA at 400 V AC (Article number: Z109N as from June 2016)

Multimeter Electrical Safety

Protection class II per DIN EN 61010-1:2011/VDE 0411-1:2011
 Measuring category II
 Operating voltage 300 V
 Pollution degree 2
 Test Voltage 2.2 kV~ per EN 61010-1:2010/VDE 0411-1:2011

Electromagnetic Compatibility (EMC)

Interference emission EN 61326-1:2013 class B
 Interference Immunity EN 61326-1:2013
 EN 61326-2-1:2013

Ambient Conditions

Accuracy range 0 °C ... +40 °C
 Operating temp. range -10 °C ... +50 °C
 Storage temp. range -25 °C ... +70 °C (without batteries)
 Relative humidity 40% ... 75%, no condensation allowed
 Elevation to 2000 m

Technical Data

Mechanical Design

Protection IP 65

Table Excerpt Regarding Significance of IP Codes

IP XY (1 st digit X)	Protection against foreign object entry	IP XY (2 nd digit Y)	Protection against the penetration of water
6	dust-proof	5	jet-water

Dimensions 200 x 87 x 45 mm

Weight Approx. 430 g with batteries

Data Interface

Type Optical via infrared light through the housing

Data transmission Serial, bidirectional (not IrDa compatible)

Protocol Device specific

Baud rate 38,400 baud

Functions **DMM:** read data
Calibrator: set/query calibration functions
and parameters

The USB X-TRA plug-in interface adapter (see accessories) is used for adaptation to the PC's USB port.

10 Maintenance and Calibration



Attention!

Disconnect the instrument from the measuring circuit before opening the battery compartment lid or fuse cover in order to replace batteries or fuses!

10.1 Displays – Error Messages

Message	Function	Meaning
FUSE	Current Measurement	Blown fuse
	In all operating modes	Battery voltage has fallen below 2.0 V
OL	Measure	Indicates overflow

10.2 Batteries



Note

Removing the Batteries During Periods of Non-Use

The integrated quartz movement draws power from the batteries even when the instrument is switched off. It is advisable to remove the batteries during long periods of non-use for this reason (e.g. vacation). This prevents excessive depletion of the batteries, which may result in damage under unfavorable conditions.



Note

Stored measurement data are lost when the batteries are replaced. In order to prevent data loss, it is advisable to backup your data to a PC with the help of **METRAwin 10** software before replacing the batteries.

The selected operating parameters remain in memory, although date and time must be reentered.

Charge level

The current battery charge level can be queried in the “**Info**” menu:

Info **bAtt: 2.75 V.**

Make sure that no battery leakage has occurred before initial start-up, as well as after long periods of storage. Continue to inspect the batteries for leakage at short, regular intervals.

If battery leakage has occurred, carefully and completely clean the electrolyte from the instrument with a damp cloth, and replace the battery before using the instrument.

If the “” symbol appears at the display, the batteries should be replaced as soon as possible. You can continue working with the instrument, but reduced measuring accuracy may result.

The instrument requires two 1.5 V batteries in accordance with IEC R 6 or IEC LR 6, or two equivalent rechargeable NiCd batteries.

Replacing the Batteries



Attention!

Disconnect the instrument from the measuring circuit before opening the battery compartment lid in order to replace the batteries.

- ⇨ Set the instrument face down onto the working surface.
- ⇨ Turn the slotted screw on the lid with the battery symbols counterclockwise.
- ⇨ Lift off the lid and remove the batteries from the battery compartment.
- ⇨ Insert two new 1.5 V mignon batteries into the battery compartment, making sure that the plus and minus poles match up with the provided polarity symbols.
- ⇨ When replacing the battery compartment lid, insert the side with the guide hooks first. Tighten the screw by turning it clockwise.
- ⇨ Please dispose of depleted batteries in accordance with environmental protection regulations!

10.3 Fuse

Testing the Fuse

The fuse is tested automatically:

- When the instrument is switched on with the rotary switch in the mA position
- When the instrument is already on and the rotary switch is turned to the mA position
- In the active current measuring range when voltage is applied

If the fuse is blown or has not been inserted, “FuSE” appears at the digital display. The fuse interrupts the current measuring ranges. All other measuring ranges remain functional.



Replacing the Fuse

If a fuse should blow, eliminate the cause of overload before placing the instrument back into service!



Attention!

Disconnect the instrument from the measuring circuit before opening the fuse cover in order to replace the fuse!

- ⇨ Set the instrument face down onto the working surface.
- ⇨ Turn the slotted screw on the cover with the fuse symbol counterclockwise.
- ⇨ Lift off the cover and pry the fuse out using the flat side of the fuse cover.
- ⇨ Insert a new fuse. Make sure that the fuse is centered, i.e. between the tabs at the sides.
- ⇨ When replacing the fuse cover, insert the side with the guide hooks first. Tighten the screw by turning it clockwise.
- ⇨ Dispose of the blown fuse with the trash.



Attention!

Use specified fuses only! If fuses with other blowing characteristics, other current ratings or other breaking capacities are used, the operator is placed in danger, and protective diodes, resistors and other components may be damaged. The use of repaired fuses or short-circuiting the fuse holder is prohibited.



Note

Testing the Fuse with the Instrument Switched On

After inserting the fuse with the instrument switched on, the instrument must be switched off briefly and then switched back on, or briefly switched to a non current measuring range and then back to the mA measuring range. If contact is poor or the fuse is blown, FUSE blinks at the display.

10.4 Housing Maintenance

No special maintenance is required for the housing. Keep outside surfaces clean. Use a slightly dampened cloth for cleaning. Avoid the use of cleansers, abrasives or solvents.

10.5 Return and Environmentally Sound Disposal

The **instrument** is a category 9 product (monitoring and control instrument) in accordance with ElektroG (German Electrical and Electronic Device Law). This device is subject to the RoHS-directive. Furthermore, we make reference to the fact that the current status in this regard can be accessed on the Internet at www.gossenmetrawatt.com by entering the search term WEEE.

We identify our electrical and electronic devices in accordance with WEEE 2012/19/EU and ElektroG with the symbol shown to the right per DIN EN 50419.



These devices may not be disposed of with the trash. Please contact our service department regarding the return of old devices.

If you use **batteries** or **rechargeable batteries** in your instrument or accessories which no longer function properly, they must be duly disposed of in compliance with the applicable national regulations.

Batteries or rechargeable batteries may contain harmful substances or heavy metal such as lead (Pb), cadmium (Cd) or mercury (Hg).

The symbol shown to the right indicates that batteries or rechargeable batteries may not be disposed of with the trash, but must be delivered to collection points specially provided for this purpose.



10.6 Recalibration

The respective measuring task and the stress to which your measuring instrument is subjected affect the ageing of the components and may result in deviations from the guaranteed accuracy.

If high measuring accuracy is required and the instrument is frequently used in field applications, combined with transport stress and great temperature fluctuations, we recommend a relatively short calibration interval of 1 year. If your measuring instrument is mainly used in the laboratory and indoors without being exposed to any major climatic or mechanical stress, a calibration interval of 2-3 years is usually sufficient.

During recalibration¹ in an accredited calibration laboratory (DIN EN ISO/IEC 17025) the deviations of your instrument in relation to traceable standards are measured and documented. The deviations determined in the process are used for correction of the readings during subsequent application.

We are pleased to perform DAkkS or factory calibrations for you in our calibration laboratory. Please visit our website at www.gossenmetrawatt.com.

By having your measuring instrument calibrated regularly, you fulfill the requirements of a quality management system per DIN EN ISO 9001.

¹ Verification of specifications or adjustment services are not part of the calibration. For products from our factory, however, any necessary adjustment is frequently performed and the observance of the relevant specification is confirmed.

10.7 Manufacturer's Guarantee

All **METRAHIT** digital multimeters and calibration instruments are guaranteed for a period of 3 years after date of shipment. The manufacturer's guarantee covers materials and workmanship. Damages resulting from use for any other than the intended purpose or operating errors, as well as any and all consequential damages, are excluded.

The calibration certificate confirms that the product conformed to the specified technical data at the time of calibration. We guarantee the observance of the specified technical data within the admissible tolerance limits for a period of 12 months from delivery.

11 Accessories

11.1 General

The extensive accessories available for our measuring instruments are checked for compliance with currently valid safety regulations at regular intervals, and are expanded as required for new applications. Currently up-to-date accessories which are suitable for your measuring instrument are listed at the following web address along with photo, order number, description and, depending upon the scope of the respective accessory, data sheet and operating instructions: www.gossenmetrawatt.com.

11.2 Technical Data for Measurement Cables (scope of delivery: KS29 safety cable set)

Electricity Safety

Maximum rated voltage,
measuring category 1000 V CAT III
Max. rated current 16 A (with **safety caps** applied 1 A)

Ambient Conditions (EN 61 010-031)

Temperature -20 °C ... + 50 °C
Relative humidity 50 ... 80%
Pollution degree 2

Application



Attention!

In conformity with standard DIN EN 61010-031, measurements in an environment according to measuring category III may only be performed with the **safety caps** applied to the test probes of the measurement cables! **Please observe the maximum values of the electrical safety of the instrument (DMM).**

For establishing contact in 4 mm jacks you have to remove the safety cap by levering out the snap lock of the **safety cap** with another sharp object (e. g. the second test probe).

11.3 NA X-TRA Power Pack (not included)

Use power packs from GMC-I Messtechnik GmbH only in combination with your instrument. This assures operator safety by means of an extremely well insulated cable, and safe electrical isolation (nominal secondary ratings: 5 V / 600 mA). Installed batteries are disconnected electronically if the power pack is used, and need not be removed from the instrument.

In the multimeter operating mode, capacitive coupling of the Z218G power pack may lead to an increased measuring error. We therefore recommend battery operation for the measurement of capacitance and AC quantities.

11.4 Interface Accessories (not included)

USB X-TRA Bidirectional Interface Adapter

This adapter makes it possible to connect the **METRACAL MC** to a USB port at a PC. The adapter allows for data transmission between the multimeter and the PC.

METRAwin 10 PC Analysis Software

METRAwin 10 PC software is a multilingual, measurement data logging program* for recording, visualizing, evaluating and documenting measured values from **METRAHIT** multimeters.

The detailed system requirements are indicated in the **METRAwin 10/METRAwin 45** installation instructions.

METRAwin 90 Calibration Software

METRAwin 90 calibration software is a multilingual program* for controlling various calibrators for electrical quantities with the help of a PC, and for documenting calibration results.

Please refer to the METRAwin 90 installation instructions for a description of the METRAwin 90-2, METRAwin 90-F and METRAwin 90-FJ product variants and their detailed system requirements.

* runs under an IBM compatible Windows operating system

12 Keyword Index

Numerics

0.diSP 62

A

Addr 67

APoFF 63

Automatic Shutdown

Disabling 17

Specifying a Time 17

AUTO-Range Function 18

B

bAtt 62

Batteries

Charge Level 76

Periods of Non-Use 76

Replacement 77

bEEP 63

C

Cable Resistance 34

Capacitance Measurement 36

Continuity Test 31

Current Clamp Sensor 40, 41

Current Clamp Transformer 42

Current Measurement

Notes 37

Scope of Functions 37

D

dAtE 64

Default Settings 64

Device Returns 78

Diode Test 32

Display Illumination 16

E

Error Messages 76

F

Fuse

Replacement 77

I

Interfaces

Not Included 81

Statuses 13

irStb 67

itEMP 62

M

Maintenance

Housing 78

Manufacturer's Guarantee 79

Measured Value Storage

DATA Function 21

Min-Max Values 22

Measurement Cables 80

Measuring Category

Significance 8

Measuring Range Selection

Automatic 18

Manual 18

Memory

Clear 24

Ending Recording 24

Querying Occupancy 24

Start Recording 23

O

OCCUP 62

Overview

Keys and Connections 12

Parameters 61

P

Power Pack

Connector Socket Location 15

Initial Start-Up 16

Not Included 80

Product Support 3

Product Support Hotline 3

R

rAtE 62

Recalibration Service 4, 79

Remote 33

Repair and Replacement Parts Service 4

Resistance Measurement 30

S

Safety Precautions 8

Scope of Delivery 2

Software Enabling 3

Status of the Infrared Receiver in the

Stand-by Mode 67

Switching the Instrument On

Manual 16

Via PC 16

Symbols	
Digital Display	13
Instrument	15
Rotary Switch Positions	14
T	
Temperature Measurement	
With Resistance Thermometers	34
With Thermocouples	33
tiME	64
U	
Use for Intended Purpose	10
V	
Voltage Comparator	29, 30
Voltage Measurement	
Notes	27
Scope of Functions	27
W	
WEEE Mark	15

Edited in Germany • Subject to change without notice • PDF version available on the Internet

 **GOSSEN METRAWATT**

GMC-I Messtechnik GmbH
Südwestpark 15
90449 Nürnberg • Germany

Phone: +49 911 8602-111
Fax: +49 911 8602-777
e-mail: info@gossenmetrawatt.com
www.gossenmetrawatt.com