

# Manual Supplement

Manual Title: 287/289 Users  
Part Number: Web-Only  
Print Date: June 2007  
Revision/Date: 2, 3/09

Supplement Issue: **8**  
Issue Date: 1/18  
Page Count: 7

---

---

This supplement contains information necessary to ensure the accuracy of the above manual.

## Change #1, 55189, 55213, 55269

On page 72, under **Resistance Specifications**, change the **Accuracy** for 500 k $\Omega$ :

From: 0.05 % + 2  
To: 0.05 % + 15

On page 74, under **Frequency Counter Specifications**, add a footnote 3 to the Duty Cycle row.

[3] For 10  $\mu$ s < pulse width <25  $\mu$ s add 1%. For 2  $\mu$ s < pulse width  $\leq$ 10  $\mu$ s add 3.5 %.

Under Pulse Width, change the **Accuracy** for 0.1000 ms:

From: 0.002 ms + 3 counts  
To: 0.002 ms + 30 counts

On page 77, under **Typical Short Circuit Current**, change **5 M $\Omega$** :

From: 0.3  $\mu$ A  
To: 1  $\mu$ A

## Change #2

On page 63, Table 11, replace Items 23 and 24 with the following:

23	TL175 Test Lead Set	1	3504931
24	Alligator Clips, one black and one red	2	3970052 (Black) 3970041 (Red)

On page 65, Table 12, replace the first Item with the following

AC172	Alligator Clips for use with the TL175 test lead set
-------	--

## Change #3, 54932, 64414

On page 1, delete the **Safety Information** bullet section.











Add the following to the list of **Warnings**:

- **Measure a known voltage first to make sure that the Meter operates correctly. If you are unsure, have the Meter examined.**

On page 3, replace the second bullet on the right column with:

- **Before measuring current, check the Meter's fuses. (See "Testing the Fuses" in the Users Manual).**

On page 4, replace the **Symbols** Table with:

Symbol	Description	Symbol	Description
~	AC (Alternating Current or Voltage)		Fuse
—	DC (Direct Current or Voltage)		Double Insulated
	Hazardous voltage		Important Information; refer to manual
	Battery (Low battery when shown on the display)		Earth ground
)	Continuity test or continuity beeper tone		Conforms to relevant Canadian and US standards
CE	Conforms to European Union directives		Conforms to relevant Australian Safety and EMC standards.
	Conforms to relevant South Korean EMC Standards		Inspected and licensed by TÜV Product Services
<b>CAT II</b>	Measurement Category II is applicable to test and measuring circuits connected directly to utilization points (socket outlets and similar points) of the low-voltage MAINS installation.		This product complies with the WEEE Directive (2002/96/EC) marking requirements. The affixed label indicates that you must not discard this electrical/electronic product in domestic household waste. Product Category: With reference to the equipment types in the WEEE Directive Annex I, this product is classed as category 9 "Monitoring and Control Instrumentation" product. Do not dispose of this product as unsorted municipal waste. Go to Fluke's website for recycling information.
<b>CAT III</b>	Measurement Category III is applicable to test and measuring circuits connected to the distribution part of the building's low-voltage MAINS installation.	<b>CAT IV</b>	Measurement Category IV is applicable to test and measuring circuits connected at the source of the building's low-voltage MAINS installation.

On page 64, replace Figure 31 with:

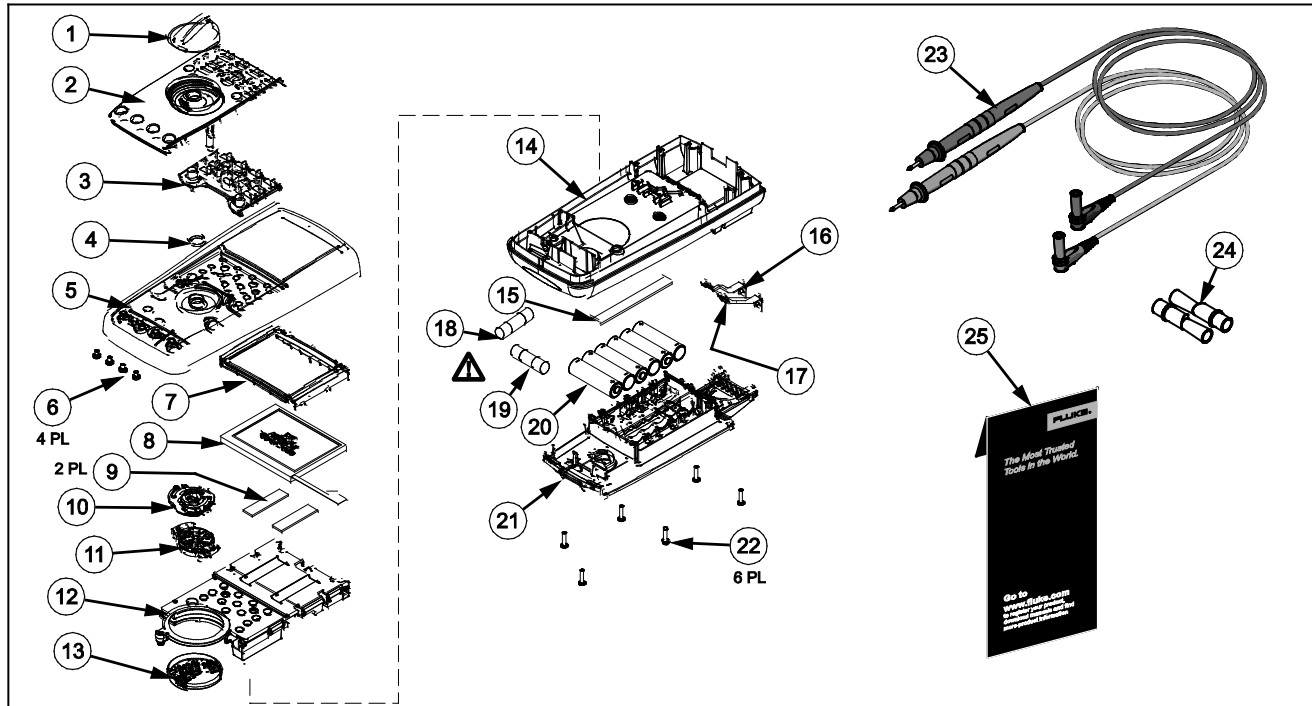

Figure 31. Replacement Parts

est40.eps

On page 63, Table 11, replace item 25, delete item 26 and replace the note with:

25	Fluke 287/289 Information Pack	4277223
<p>⚠ To ensure safety, use the exact replacement only.                  [1] The Users manual is available through <a href="http://www.Fluke.com">www.Fluke.com</a>. Click on Support and then Product Manuals.</p>		

On page 66 & 67 delete the **Vibration, Shock, Safety Standard, Electromagnetic Compatibility Standards (EMC)** and the **Certifications** sections and replace with:

**Safety**

- General ..... IEC 61010-1, Pollution Degree 2
- Measurements ..... IEC 61010-2-033, CAT IV 600 V/CAT III 1000 V

**Electromagnetic Compatibility (EMC)**

- International ..... IEC 61326-1: Portable Electromagnetic Environment; IEC 61326-2-2  
 CISPR 11: Group 1, Class A

*Group 1: Equipment has intentionally generated and/or uses conductively-coupled radio frequency energy that is necessary for the internal function of the equipment itself.*

*Class A: Equipment is suitable for use in all establishments other than domestic and those directly connected to a low-voltage power supply network that supplies buildings used for domestic purposes. There may be potential difficulties in ensuring electromagnetic compatibility in other environments due to conducted and radiated disturbances.*

*Caution: This equipment is not intended for use in residential environments and may not provide adequate protection to radio reception in such environments.*

*Emissions that exceed the levels required by CISPR 11 can occur when the equipment is connected to a test object.*

Korea (KCC) .....Class A Equipment (Industrial Broadcasting & Communication Equipment)

*Class A: Equipment meets requirements for industrial electromagnetic wave equipment and the seller or user should take notice of it. This equipment is intended for use in business environments and not to be used in homes.*

## Change #4, 66733

On page 69, replace Notes 2 and 3 in the **AC Current Specifications** table:

- [2] 10 A to 20 A, 30 seconds on, 10 minutes off. >10 A not specified.
- [3] 400 mA continuous; 400 mA to 550 mA for 2 minutes on, 1 minute off.

On page 71, replace Notes 2 and 4 in the **DC Current Specifications** table:

- [2] 10 A to 20 A, 30 seconds on, 10 minutes off. >10 A not specified.
- [4] 400 mA continuous; 400 mA to 550 mA for 2 minutes on, 1 minute off.

## Change #5, 575

On page 70, in the **DC Voltage Specification** table, replace note 1 with:

- [1] Add 20 counts in dual display ac over dc, dc over ac or ac+dc. 289 only.

On page 77, in the **Input Characteristics** table LoZ, Input Impedance, change:

- From: 3.2 k $\Omega$  <100 pF (ac-coupled)
- To: 3.2 k $\Omega$  <100 pF (dc-coupled)

## Change #6, 529, 575

On page 63, Table 11, replace item 16 with:

16	Battery Contact, Negative	1	2578375
----	---------------------------	---	---------

On page 66, replace the **Fuse Protection** rows and the **Battery type** row with:

- Fuse Protection for mA or  $\mu$ A inputs**..... 0.44 A, 1000 V, IR 10 kA
- Fuse Protection for A input**..... 11 A, 1000 V, IR 17 kA
- Battery Type**..... 6 AA Alkaline batteries, IEC LR6

On page 66, under **General Specifications**, Safety Standards, remove the UL row.