

FLIR MODEL IM75-2

Insulation Tester / Digital MultiMeter

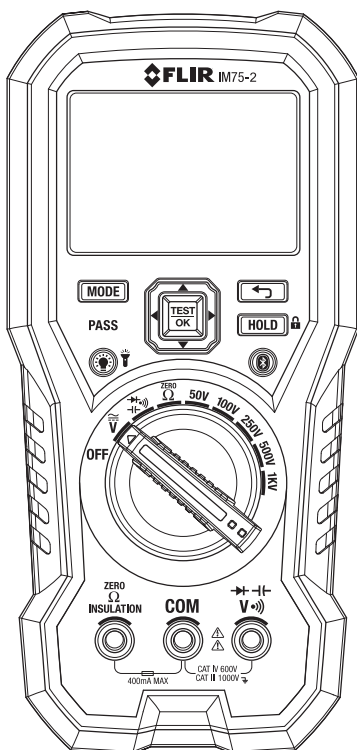

Table of Contents

1. DISCLAIMERS	4
1.1 Copyright	4
1.2 Quality Assurance	4
1.3 Documentation	4
1.4 Disposal of Electronic Waste	4
2. SAFETY	5
2.1 FCC Compliance	6
2.2 Industry Canada Compliance	7
3. INTRODUCTION	8
3.1 Key Features	8
4. METER DESCRIPTION	9
4.1 Meter Sections	9
4.2 Function Switch Positions	10
4.3 Function Buttons, Selector Pad, and Rotary Switch	10
4.3.1 Selector Pad	11
4.3.2 Rotary Switch	11
4.4 Display Description	12
4.5 Display Icons and Indicators	13
5. OPERATION	14
5.1 Powering the Meter	14
5.1.1 Auto Power Off	14
5.2 Manual AC/DC Selection	14
5.3 Auto Range	14
5.4 ‘Smart’ Out-of-Range Warnings	14
5.5 Data Hold and Auto-Hold Modes	14
5.5.1 Data Hold Mode	14
5.5.2 Auto-Hold mode	14
5.6 Voltage Measurements	15
5.7 Insulation Resistance Measurements	15
5.7.1 PI/DAR Test	15
5.8 Earth Bond Resistance Measurements (ZERO Ω)	16

5.9 Continuity Test	16
5.10 Diode Test	16
5.11 Capacitance Measurements	17
5.12 Extended Functionality	17
5.12.1 Selecting Modes	17
5.12.2 VFD Mode (ACV only)	18
5.12.3 Frequency Mode (ACV only)	18
5.12.4 Pass/Fail Mode (COMPARE)	18
5.12.5 Setup Utility	18
5.12.6 Silent Mode	19
5.12.7 Data Recording Mode (99-point)	19
5.13 Keypad Lockout	19
5.14 Streaming Measurement Data using METERLiNK	20
5.14.1 General	20
5.14.2 Procedure	20
6. MAINTENANCE	21
6.1 Cleaning and Storage	21
6.2 Battery Replacement	21
6.3 Fuse Replacement	21
6.4 Disposal of Electronic Waste	21
7. SPECIFICATIONS	22
7.1 General specifications	22
7.2 Electrical Range Specifications	23
7.3 Input Specifications	25
8. CUSTOMER SUPPORT	26
9. WARRANTY	27
9.1 FLIR Limited Lifetime Warranty	27

1. Disclaimers

1.1 Copyright

© 2023, FLIR Systems, Inc. All rights reserved worldwide. No parts of the software including source code may be reproduced, transmitted, transcribed, or translated into any language or computer language in any form or by any means, electronic, magnetic, optical, manual, or otherwise, without the prior written permission of FLIR Systems.

The documentation must not, in whole or part, be copied, photocopied, reproduced, translated, or transmitted to any electronic medium or machine-readable form without prior consent, in writing, from FLIR Systems.

Names and marks appearing on the products herein are either registered trademarks or trademarks of FLIR Systems and/or its subsidiaries. All other trademarks, trade names or company names referenced herein are used for identification only and are the property of their respective owners.

1.2 Quality Assurance

The Quality Management System under which these products are developed and manufactured has been certified in accordance with the ISO 9001 standard.

FLIR Systems is committed to a policy of continuous development; therefore, we reserve the right to make changes and improvements on any of the products without prior notice.

1.3 Documentation

To access the latest manuals and notifications, go to the Download tab at: <https://support.flir.com>. It only takes a few minutes to register online. In the download area you will also find the latest releases of manuals for our other products, as well as manuals for our historical and obsolete products.

1.4 Disposal of Electronic Waste



As with most electronic products, this equipment must be disposed of in an environmentally friendly way, and in accordance with existing regulations for electronic waste.

Please contact your FLIR Systems representative for more details.

2. Safety

Safety Notes

- Before operating the device, you must read, understand, and follow all instructions, dangers, warnings, cautions, and notes.
- FLIR Systems reserves the right to discontinue models, parts or accessories, and other items, or to change specifications at any time without prior notice.
- Remove the batteries if the device is not used for an extended period.





Warning Statements

- Do not operate the device if you do not have the correct knowledge. Formal qualifications and/or national legislation for the electrical inspections can apply. Incorrect operation of the device can cause damage, shock, injury or death to persons.
- Do not start the measuring procedure before you have set the function switch to the correct position. This can cause damage to the instrument and can cause injury to persons.
- Do not change to resistance when you measure the voltage. This can cause damage to the instrument and can cause injury to persons.
- You must disconnect the test leads from the circuit that you did a test on before you change the range. If you do not do this, damage to the instrument and injury to persons can occur.
- Do not replace the batteries before you remove the test leads. This can cause damage to the instrument and can cause injury to persons.
- Do not use the device if the test leads and/or the device show signs of damage. Injury to persons can occur.
- Be careful when you do the measurements if the voltages are more than 25 VAC rms or 35 VDC. There is a risk of shock from these voltages. Injury to persons can occur.
- Do not do diode, resistance, or continuity tests before you have removed the power from capacitors and other devices under test during a measurement. Injury to persons can occur.
- Do not use the device as a tool to identify live terminals. You must use the correct tools. Injury to persons can occur if you do not use the correct tools.
- Make sure that children cannot touch the device. The device contains dangerous objects and small parts that children can swallow. If a child swallows an object or a part, speak with a physician immediately. Injury to persons can occur.
- Do not let children play with the batteries and/or the packing material. These can be dangerous for children if they use them as toys.
- Do not touch expired or damaged batteries without gloves. Injury to persons can occur.
- Do not cause a short-circuit of the batteries. This can cause damage to the instrument and can cause injury to persons.
- Do not put the batteries into a fire. Injury to persons can occur.

Cautions

Do not use the device for a procedure that it is not made for. This can cause damage to the protection.

	This symbol, adjacent to another symbol or terminal, indicates that the user must refer to the manual for further information.
	This symbol, adjacent to a terminal, indicates that, under normal use, hazardous voltages may be present.
	Double insulation.



UL listing is not an indication or a verification of the accuracy of the meter

2.1 FCC Compliance

This device complies with part 15 of the FCC Rules. Operation is subject to the following two conditions:

1. This device may not cause harmful interference.
2. This device must accept any interference received, including interference that may cause undesired operation.

This equipment has been tested and found to comply with the limits for a Class B digital device, pursuant to part 15 of the FCC Rules. These limits are designed to provide reasonable protection against harmful interference in a residential installation. This equipment generates, uses, and can radiate radio frequency energy and, if not installed and used in accordance with the instructions, may cause harmful interference to radio communications. However, there is no guarantee that interference will not occur in an installation. If this equipment does cause harmful interference to radio or television reception, which can be determined by turning the equipment off and on, the user is encouraged to try to correct the interference by one or more of the following measures:

1. Reorient or relocate the receiving antenna.
2. Increase the separation between the equipment and receiver.
3. Connect the equipment into an outlet on a circuit different from that to which the receiver is connected.
4. Consult the dealer or an experienced radio/TV technician for help.



WARNING

Changes or modifications not expressly approved by the party responsible for compliance could void the user's authority to operate the equipment.

2.2 Industry Canada Compliance

This device complies with part 15 of the FCC Rules. Operation is subject to the following two conditions:

This device complies with Industry Canada license-exempt RSS standard(s). Operation is subject to the following two conditions: (1) this device may not cause interference, and (2) this device must accept any interference, including interference that may cause undesired operation of the device.

3. Introduction

Thank you for selecting the FLIR IM75-2 Insulation Test / Digital MultiMeter. This device is shipped fully tested and calibrated and, with proper use, will provide years of reliable service.

3.1 Key Features

- 4000 count extra-large digital dual display with backlighting
- Auto Range with smart over-range indication
- Auto Hold and Standard Data Hold features
- On-screen menu selection and navigator key drive
- Variable-frequency drive mode (low-pass filter)
- Front panel insulation resistance test voltage selector
- COMPARE feature with front panel color coded PASS/FAIL LED indication
- 0.1% DCV accuracy
- 99-record data record/recall memory
- High power built-in work lights
- METERLiNK® app compatibility
- Safety Category Rating: CAT IV-600V, CAT III-1000V

4. Meter Description

4.1 Meter Sections

1. Courtesy Work lights
2. LCD Display
3. Pass-Fail (green/red) LED
4. Rotary Function Switch
5. Function Buttons (detailed below)
6. Positive (+) probe input jack for Voltage, Capacitance, Diode, & Continuity
7. COM (negative -) probe input jack
8. Positive (+) probe input jack for insulation resistance and earth bond resistance

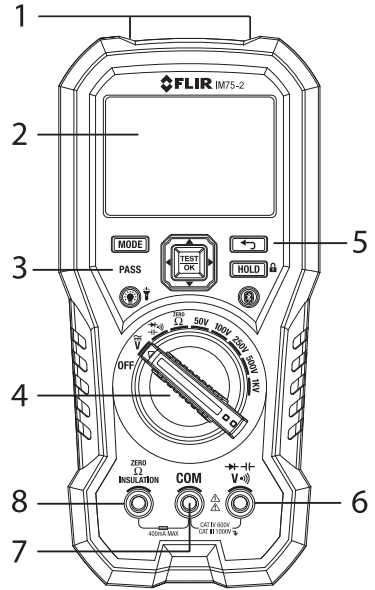

Fig 4-1 Front View

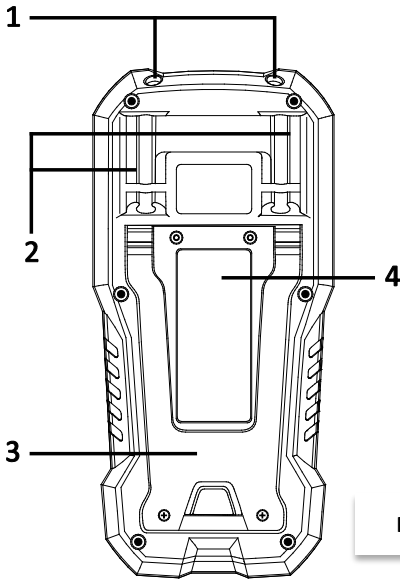











Fig 4-2 Rear View

1. Courtesy Work Lights
2. Test Probe Holders
3. Tilt Stand
4. Battery and Fuse Access

4.2 Function Switch Positions

OFF	The meter is switched OFF and in full power-saving mode.
	The meter can measure voltage (V) through the probe inputs.
	The meter can measure capacitance, diode polarity or continuity through the probe inputs. The type of measurement is chosen by the MODE button.
ZERO Ω	Earth Bond Resistance testing mode.
50V, 100V, 250V, 500V, 1KV: Insulation resistance test voltage selections	

4.3 Function Buttons, Selector Pad, and Rotary Switch

	<ul style="list-style-type: none"> • Use this button to change the operating mode of the meter (ex: AC vs. DC) • Also selects Insulation Resistance values to compare for PASS/FAIL testing
	<p>Press to HOLD readings on the display during normal DMM measuring modes (see Section 5.5 <i>Data Hold and Auto-Hold Modes</i>). Press and hold for Keypad lockout mode (see Section 5.13 <i>Keypad Lockout</i>).</p> <p>In INSULATION TESTING MODE this button will serve to enable the test lock function for continuous insulation resistance testing. See Section 5.7 Insulation Resistance Measurements for further information.</p>
	Use this Selector Pad to start/stop Insulation Resistance Tests, to enable extended functionality modes, and to navigate mode menu options. Further details provided in Section 4.3.1 <i>Selector Pad</i>
	The Rotary Switch is used to select a measurement function. Details are provided in Section 4.3.2 <i>Rotary Switch</i>
	Press this button to exit an extended functionality mode.
	<ul style="list-style-type: none"> • Press this button to enable/disable the display backlight. • Press and hold the button for 2 seconds to enable/disable the work light.
	Press to enable/disable METERLiNK communication, see section 5.14 <i>Streaming measurement data using METERLiNK</i> .

4.3.1 Selector Pad

There are five (5) 'soft' function buttons arranged in a square, as shown below. The functions change depending on the sub-function chosen at the time. Generally, the arrow buttons are used for navigation and the TEST-OK button is used for selecting an object or starting a test. Detailed information below:



Fig 4-3 Selector Pad

Pressing the **TEST OK** button selects a menu-driven option. The **TEST OK** button is also used to enter the sub-menus for selection screens.

NOTE: When in **INSULATION TESTING MODE** pressing and holding TEST-OK outputs a test voltage (until the button is manually released). In Test Lock mode this button (used in conjunction with the HOLD/LOCK button) is used to Start and Stop continuous Insulation Resistance tests. See Section 5. *Insulation Resistance Measurements* for further details. Do not confuse the Insulation Resistance test lock feature with the Keypad Lockout feature (section 5.13).

The LEFT (←) button scrolls to previous choices in the current level of the menu. When reaching the start of a group of selections, further presses of the LEFT button wraps to the end of the list.

The RIGHT (→) button scrolls to next choices in the current level of the menu. When reaching the end of a group of selections, further presses of the RIGHT button wraps to the start of the list.

The UP (↑) button scrolls to previous selectable options in the current level of the menu.

When reaching the start of a group of selections, further presses of the UP button are ignored.

The DOWN (↓) button scrolls to previous selectable options in the current level of the menu.

When reaching the end of a group of selections, further presses of the DOWN button are ignored.

4.3.2 Rotary Switch

There are nine (9) dedicated Rotary Switch positions:



- **OFF:** The meter is switched OFF.
- **AC/DC VOLTAGE:** The meter can measure voltage through the probe inputs. The type of measurement (AC/DC) is chosen by the MODE button. The default measurement is AC voltage.

- **CAPACITANCE/DIODE/CONTINUITY:** The meter can measure capacitance, diode polarity or continuity through the probe inputs. The type of measurement is chosen by the MODE button.
- **Zero Ω :** The meter can measure earth-bond resistance, through the probe inputs. The measurement unit is Ohms (Ω).
- **50V:** The meter can source a 50VDC TEST Voltage and measure Insulation Resistance through the Zero Ω /Insulation and COM probe inputs.
- **100V:** The meter can source a 100VDC TEST Voltage and measure Insulation Resistance through the Zero Ω /Insulation and COM probe inputs.
- **250V:** The meter can source a 250VDC TEST Voltage and measure Insulation Resistance through the Zero Ω /Insulation and COM probe inputs.
- **500V:** The meter can source 500VDC TEST Voltage and measure Insulation Resistance through the Zero Ω /Insulation and COM probe inputs.
- **1000V:** The meter can source 1000VDC TEST Voltage and measure Insulation Resistance through the Zero Ω /Insulation and COM probe inputs.

4.4 Display Description

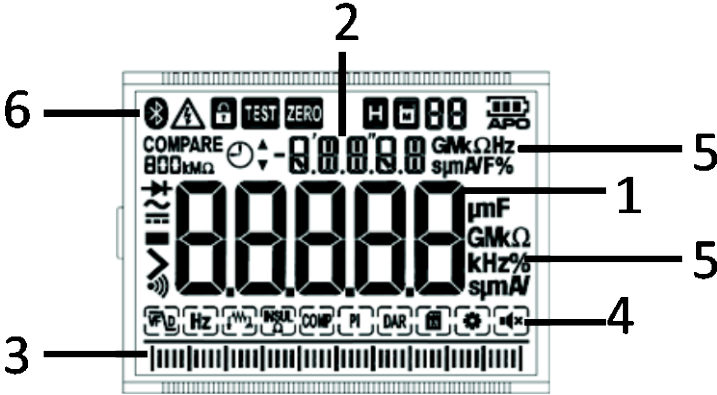















Fig 4-4 Display

1. Main display area
2. Secondary display area
3. Bar graph (matches the reading on the main display)
4. Modes of operation (detailed later in this guide)
5. Units of measure for primary and secondary displays
6. Alerts and status icons (detailed below)

4.5 Display Icons and Indicators

	Indicates that Bluetooth communication is active
TEST	Indicates an Insulation Test in progress and test voltage is present
	Indicates that the measured voltage is greater than 30 V (AC or DC)
H	Indicates that the meter is in Hold mode (solid H) or auto hold (flashing H)
	Indicates that the meter is in locked mode
	Memory icon shown with the active memory location (1-99)
	Indicates the battery voltage status
APO	Indicates that the auto power off function is enabled
	Indicates that the meter is measuring AC voltage
	Indicates that the meter is measuring DC voltage
	Analog bar graph
	VFD (variable frequency drive) mode icon
	Frequency mode icon
	Earth Bond Resistance icon
INSUL	Insulation Resistance icon
COMP	Compare function icon
PI	Polarization Index icon
DAR	Dielectric Absorption Ratio icon
	Settings mode icon
	Silent mode icon

5. Operation

Note: Before operating the device, you must read, understand, and follow all instructions, dangers, warnings, cautions, and notes.

Note: When the meter is not in use, the function switch should be set to the OFF position.

Note: When connecting the probe leads to the device under test, connect the COM (negative) lead before connecting the positive lead. When removing the probe leads, remove the positive lead before removing the COM (negative) lead.

5.1 Powering the Meter

1. Set the function switch to any position to switch on the meter.
2. If the battery indicator  shows that the battery voltage is low or if the meter does not power on, replace the battery. See section 6.2 *Battery Replacement*.

5.1.1 Auto Power Off

The meter enters sleep mode after 30 minutes of inactivity. The meter beeps three times 20 seconds before powering off. Press any button or turn the Rotary Switch to prevent the meter from powering off. The auto power off time-out is then reset. To disable auto power off (APO) press the MODE button while turning on the meter. To change the APO time, read section 5.12.6 *Setup Utility*

5.2 Manual AC/DC Selection

When measuring voltage, press the **MODE** button to select AC or DC voltage.

5.3 Auto Range

Auto-Range is the only mode of operation for Capacitance; ranges are automatically selected by the meter. Insulation Resistance tests allow for voltage test selection using the rotary switch.

5.4 'Smart' Out-of-Range Warnings

If the input is over/under the full-scale range, the display will show >x or <x, where x is the high or low end of the full-scale range.

5.5 Data Hold and Auto-Hold Modes

These two modes are discussed in detail below. In the Settings menu, if Auto-Hold is set to OFF, the meter will operate in the standard Hold mode. If Auto-Hold is set to ON in the settings menu, the meter will operate in the Auto-Hold mode.

5.5.1 Data Hold Mode



In Data Hold mode, press the HOLD button to capture the measurement that is shown on the main display. The captured reading will be displayed in the secondary, upper display area (the main display will then function normally). The 'H' display icon will appear solid on the LCD in the Hold mode. To exit the Hold mode, press the HOLD button again.

5.5.2 Auto-Hold mode

If Auto-Hold mode is switched ON in the settings menu, press the HOLD button to activate Auto-Hold mode (the 'H' display icon will appear flashing). In Auto-Hold mode readings are

captured in the same way as in standard Hold mode. The difference is that the captured reading, displayed on the smaller, secondary display digits, will update whenever a reading 50 digits higher or lower than the captured reading is measured. To exit the Auto-Hold mode press the HOLD button.

5.6 Voltage Measurements

1. Set the function switch to the  position.
2. Insert the black probe lead into the COM terminal and red probe lead into the V terminal.
3. Use the **MODE** button to select AC or DC voltage measurements.
 - The  indicator will be displayed for AC measurements.
 - The  indicator will be displayed for DC measurements.
4. Connect the probe leads in parallel to the part under test
5. Read the voltage value on the display

5.7 Insulation Resistance Measurements

1. Use the rotary switch to select the insulation voltage (50V, 100V, 250V, 500V, or 1kV).
2. Insert the black probe lead into the COM terminal and red probe lead into the Insulation terminal.
3. Select **INSUL** to enable the Insulation Resistance Function mode as described in section 5.12.1 *Selecting modes*.
4. During the Test, the insulation voltage will appear in the secondary (upper) reading area. The resistance will be shown in the main reading area.
5. Press **TEST OK** to start test.
6. To lock the test for continuous testing, press the **HOLD/LOCK** button (lock icon will appear) and then press **TEST OK** to test continuously.
7. The **TEST** icon on the LCD will be shown while the voltage is outputted.
8. Press **TEST OK** again to stop the test



NOTE: The 99-point Data Record memory function cannot be activated in the usual way while using the Insulation Resistance function (since the **TEST OK** button is used for testing in this case and not for saving readings). The last reading, however, is held on the display and can then be saved in the normal way as described in the Extended Functionality section below under Section 5.12.7 *Data Record Mode*.

5.7.1 PI/DAR Test

Note: PI (Polarization Index); DAR (Dielectric Absorption Ratio)

1. Select the **PI** or **DAR** test as described in section 5.12.1 *Selecting modes*.
2. Press the **TEST OK** button to test.
3. Press the **MODE** button to show the test time at the upper reading area. (LCD will show CLOCK icon and the elapsed time). PI is a ten-minute test and DAR is a one-minute test.
4. The test will stop automatically, and the result (ratio) will be shown on the main display area. The PASS/FAIL LED will indicate the test result (Green for PASS, and Red for FAIL).



5.8 Earth Bond Resistance Measurements (ZERO Ω)

1. Move the function dial to the Earth-bond resistance position (**ZERO Ω**); the Earth-bond resistance icon  will appear.
2. Insert the black probe lead into the COM terminal and red probe lead into the ZERO/Ohm/Insulation terminal.
3. Before testing, short the ends of the probes and press the **MODE** button. The **ZERO** icon will appear on the display and the offset value will be stored. If the test leads are not shorted or if there is residual resistance, the display will show the **> 2.00** ohms (this indication could be due to faulty leads, improper test lead insertion, or meter problem. Tests should not be attempted until root cause of the high resistance is determined).
4. Connect the test leads to the Device under test.
5. Press **TEST OK** to run a test.
6. To lock the test ON, press the **HOLD/LOCK** button (the LOCK icon  will appear) and then press **TEST OK** to test continuously.
7. Press **TEST OK** again to stop the test.
8. Note that the Earth Bond Resistance Measurement mode can also be used to measure standard resistance to 40kohms

NOTE: The 99-point Data Record memory function cannot be activated in the usual way while using the Earth Bond Resistance function (since the **TEST OK** button is used for testing in this case and not for saving readings). The last reading, however, is held on the display and can then be saved as described in the Extended Functionality section below under Section 5.12.7 *Data Recording Mode*.

5.9 Continuity Test

Warning: Do not do diode, resistance or continuity tests before removing the power from capacitors and other devices under test during a measurement. Injury to persons can occur.

1. Set the function switch to the  position.
2. Insert the black probe lead into the COM terminal and red probe lead into the V terminal.
3. Use the **MODE** button to select continuity measurement. The  indicator will be displayed.
4. Insert the black probe lead into the COM (negative) terminal and the red probe lead into the positive terminal.
5. Touch the tips of the probe across the circuit or component under test.
6. If the resistance is $30 \pm 5 \Omega$ (nominal) or less, the meter will beep.

Note: This threshold is user selectable in the *SET UP* menu under the *Cntin (continuity)* setting: Range: 10-50 Ω ; Increment: 1; Default: 30 Ω .

5.10 Diode Test

Warning: Do not do diode, resistance, or continuity tests before you have removed the power from capacitors and other devices under test during a measurement. Injury to persons can occur.

1. Set the function switch to the  position.

2. Use the **MODE** button to select the diode test function. The $\rightarrow|+$ indicator will be displayed.
3. Insert the black probe lead into the COM (negative) terminal and the red probe lead into the positive V terminal.
4. Touch the tips of the probes across the diode or semiconductor junction under test. Make a note of the value on the display.
5. Reverse the polarity of the probes, by interchanging the probe test locations.
6. Touch the tips of the probe across the diode or semiconductor junction under test. Make a note of the new value on the display.
7. The diode or semiconductor junction can be evaluated as follows:

If one of the readings displays a value (Typically 0.4.00 to 0.900 V) and the other reading displays a value (-0.400 to -0.900 V), the component is good.

If both readings display OL, the component is either open or shorted.
Use Continuity mode to determine if it is open or shorted.

5.11 Capacitance Measurements

Warning: Do not do capacitance tests before removing the power to the capacitor or other devices under test during a measurement. Injury to persons can occur.

1. Set the function switch to the $\downarrow(-)$ position.
2. Use the **MODE** button to select the capacitance measurement. The F (Farad) unit will be displayed.
3. Insert the black probe lead into the COM (negative) terminal and the red probe lead into the positive terminal.
4. Touch the tips of the probe across the part under test.
5. Read the capacitance value on the display.

Note: For very large capacitance values, it may take several seconds for the measurement to settle and the final reading to stabilize.

5.12 Extended Functionality

A variety of modes are available that provide extended functionality as detailed below.

5.12.1 Selecting Modes

The mode icons applicable for the selected measurement type are displayed in the lower part of the display. When a mode is enabled, the icon is framed.



Fig 5-1 Mode Icons

Use the left/right arrow buttons to navigate to the desired mode icon. The currently selected icon will flash.

1. Press the **TEST OK** button to enable the selected (flashing) mode.

2. Use the up/down arrow buttons to step through the mode options (if any). Refer to the section related to the specific mode for detailed instructions.
3. Press the **TEST OK** button to disable the selected (flashing) mode.

5.12.2 VFD Mode (ACV only)

In VFD (variable-frequency drive) mode, high-frequency noise is eliminated from the voltage measurement using a low-pass filter. VFD mode is available when measuring ACV.

1. Select  and then press the **TEST OK** button to enable the selected (flashing) mode.

5.12.3 Frequency Mode (ACV only)

In Frequency mode, the frequency is displayed in the main display and the period is displayed in the secondary display. Frequency mode is available when measuring AC voltage.

1. Select  and enable Frequency mode as described in section 5.12.1, *Selecting modes*.

5.12.4 Pass/Fail Mode (COMPARE)

1. Select the desired insulation voltage value using the rotary switch.
2. Select  and enable the Pass/Fail Function mode as described in section 5.12.1 *Selecting modes*.
3. Use the **MODE** button to select the resistance value to compare. Resistance value segments and a COMPARE icon are shown on the LCD. See the test voltages and corresponding resistance value options in the table below.
4. Press TEST to start the process.
5. Observe the green light / red light for PASS / FAIL indication.

Test Voltages (V)	Resistance Options (kΩ)	Resistance Options (MΩ)
50	100 /200 /500	1/2/5/10/20/50
100		1/2/5/10/20/50/100
250		1/2/5/10/20/50/100/200
500		1/2/5/10/20/50/100/200/500
1000		1/2/5/10/20/50/100/200/500

5.12.5 Setup Utility

In Setup, define the settings for various meter options:

- Auto power off (indicated by the text *APO*): A mode where the time period after which the meter enters sleep mode can be set. The range is 1 to 30 minutes, or OFF. The factory default is 10 minutes.
- Auto backlight off (indicated by the text *b.Lit*): A mode where the time period after which the backlight turns off can be set. The range is 1 to 30 minutes, or OFF. The factory default is 5 minutes.
- Continuity threshold (indicated by the text *Cntin*): A mode where the threshold for continuity tests can be set.
- Auto hold (indicated by the text *A.Hold*): Select Auto hold mode ON (Auto hold mode active) or OFF (Data hold mode active). For more information, see section 5.5 *Data hold mode and Auto hold mode*.

1. Select  and enable Setup mode as described in section 5.12.1 *Selecting modes*.
2. Use the up/down arrows button to cycle through the mode options *APO*, *b.Lit*, *Cntin*, *A.Hold*, and *RESET* shown on the secondary display.
3. Press the **TEST OK** button to activate the displayed option.
 - *APO*: Use the left/right arrow buttons to change the auto power off time.
 - *b.Lit*: Use the left/right arrow buttons to change the auto backlight off time.
 - *A.Hold*: Use the left/right arrow buttons to configure auto hold/data hold. *On* indicates that the auto hold mode is active. *Off* indicates that the data hold mode is active.
 - *Cntin*: Use the left/right arrow buttons to change the continuity threshold.
 - *RESET*: Press the **TEST OK** button to reset the settings to the factory default.

5.12.6 Silent Mode

In Silent mode, the alert beeper is disabled. Silent mode does not affect the continuity beeper. Select and enable Silent mode  as described in section 5.12.1 *Selecting modes*.

5.12.7 Data Recording Mode (99-point)

The meter has 99 memory locations for the storage of measurement data.

Select and enable MEM mode  as described in section 5.12.1 *Selecting modes*.

Use the arrow keys to cycle through the mode options: *SAVE*, *LOAD*, and *CLEAR* shown on the secondary display.

SAVE: The data on the main display is saved to a memory location indicated by the '88' in the upper display area.

LOAD: The data stored in the memory location (identified by the '88' indicator) is displayed.

Use arrow keys to scroll the memory locations. Use the  button to exit the *LOAD* mode.

CLEAR: The data in all memory locations is erased.

5.13 Keypad Lockout

In Lockout mode the meter ignores all button presses except **HOLD**. The auto power off function, see section 5.1.1 *Auto Power off*, is disabled in Lockout mode.

Press and hold the **HOLD/LOCK** button for 3 seconds to enter/exit the lockout mode. In lockout mode, the lock indicator is displayed. Do not confuse Lockout mode with the test lock feature used for continuous Insulation Resistance testing (see Section 5.7 *Insulation Resistance Measurements*).

5.14 Streaming Measurement Data using METERLiNK

5.14.1 General

You can stream measurement data to a mobile device using the METERLiNK app. The app is available from the Apple Store® (iOS) or from Google Play™ (Android).

5.14.2 Procedure

1. Download the METERLiNK app to your mobile device and open the app.
2. Power the meter and select the desired measurement mode.
3. Press the meter's Bluetooth button  to enable communications.
4. Follow the instructions and prompts on the METERLiNK app screens.

6. Maintenance

6.1 Cleaning and Storage

Clean the meter with a damp cloth and mild detergent; do not use abrasives or solvents.

If the meter is not to be used for an extended period, remove the batteries and store them separately.

6.2 Battery Replacement

The Battery symbol flashes with no 'bars' when the batteries have reached a critical level of 7.0V. The symbol stays active and visible while the LCD is powered.

The meter displays readings within specifications while the low battery indicator is on. When this is no longer possible, the display must be blanked. The meter powers off before it displays an out of tolerance voltage.

1. To avoid electrical shock, disconnect the meter if connected to a circuit, remove the probe from the terminals, and set the function switch to the OFF position before attempting to replace the batteries.
2. Unscrew and remove the battery compartment cover.
3. Replace the six standard AAA batteries, observing correct polarity.
4. Secure the battery compartment cover.



Never dispose of used batteries or rechargeable batteries in household waste. As consumers, users are legally required to take used batteries to appropriate collection sites, the retail store where the batteries were purchased, or wherever batteries are sold.

6.3 Fuse Replacement

The fuse accessed via the battery compartment cover. The fuse is rated 440mA/1000V, ceramic fast blow with a minimum Interrupt Rating of 10kA.

6.4 Disposal of Electronic Waste



As with most electronic products, this equipment must be disposed of in an environmentally friendly way, and in accordance with existing regulations for electronic waste. Please contact your FLIR Systems representative for more details.

7. Specifications

7.1 General specifications

Display	4,000-count with bar graph
Controls	9-position rotary switch
	4-way Selector Pad with center OK/TEST button
	LED: Pass (Green), Fail (Red)
	(5) dedicated function buttons: Mode, Cancel, Hold/Lock, Bluetooth, Backlight
Backlight	White LED
Work Lights	White LED array
Measurement Rate	2 samples per second, nominal
Display Rate	2 times per second
Input Impedance	10M Ω VDC/VAC < 100pF
AC Voltage Bandwidth	50Hz to 500Hz
Power Supply	6 x 'AAA' (LR03) batteries
Battery Life Considerations	<p>The meter can perform 1200 Earth-Bond resistance measurements with new alkaline batteries. These are standard tests of 1Ω with a duty cycle of 5 seconds ON and 25 seconds OFF.</p> <p>Insulation Resistance: The meter can perform 300 Insulation Resistance tests with new alkaline batteries. These are standard tests of 1MΩ with a duty cycle of 5 seconds ON and 25 seconds OFF. This does not include Bluetooth or Backlight use.</p>
Auto Power Off (APO)	User programmable OFF to 30 minutes in 1-minute increments, with audible pre-alert (20 seconds)
Measurement Types	True RMS AC Volts, DC Volts, Earth Bond Resistance, Insulation Resistance, Capacitance, Diode, and Continuity
Over-current Protection (fuse)	440mA/1000V, ceramic fast blow fuse with a minimum Interrupt Rating of 10kA
Polarization Index and Dielectric Absorption Ratio Tests	<p>PI (Polarization Index) = R10-min/R1-min DAR (Dielectric Absorption Ratios) = R1-min/R30-sec Where R10-min: The insulation resistance measured at the 10-minute point after pressing the TEST button. R1-min: The insulation resistance measured at the 1-minute point after pressing the TEST button. R30-sec: The insulation resistance measured at the 30 second point after pressing the TEST button.</p>

Other Indications	Progressive Low Battery, Over Range
Internal Memory	(99) storage locations
Operating Temperature	32 to 122°F (0 to 50°C)
Storage Temperature	-4 to 140°F (-20 to 60°C)
Operating Humidity	Max 80% up to 95°F (35°C) decreasing linearly to 60% at 113°F (45°C)
Storage Humidity	80% maximum
Indoor use only	
Altitude	6561 ft. (2000 m)
Dimensions	2.4 x 3.9 x 8.2 in. (60.7 x 98.1 x 207.1 mm)
Weight	1.33 lbs. (605 g), including batteries
Agency Approvals	FCC Class B, CE, UL, RCM, UKCA
IP Rating	IP54
Drop test rating	9.8 ft. (3 m)

7.2 Electrical Range Specifications

Note: Accuracy is stated at 65°F to 83°F (18°C to 28°C) and less than 75% RH)

Function	Range	Resolution	Accuracy of Reading
DC Voltage	1000.0V	0.1V	± (0.1% + 5 digits)
AC Voltage	1000.0V	0.1V	50Hz to 60Hz ± (1.5% + 5 digits); 61Hz to 500Hz ± (2.0% + 5 digits)
VFD AC Voltage	1000.0V	0.1V	50 to 60Hz ± (1.5% + 5 digits); 61 to 400Hz ± (5.0% + 5 digits)

- Notes:**
1. Measurement start-voltage: <50V for VAC (add 20 digits for accuracy)
 2. VFD/LPF Cutoff: 800Hz (-3dB point)
 3. Input Impedance 10MΩ (less than 100pF)

Function		Range	Resolution	Accuracy of Reading
Earth-Bond Resistance		40.00 Ω	0.01Ω	± (1.5% + 5 digits) *
		400.0 Ω	0.1Ω	± (1.5% + 3 digits)
		4000Ω 40.00kΩ	1Ω 0.01KΩ	

- Notes:**
- * ≤ 1.00Ω add 3 digits.
 - Open Circuit Test Voltage: >4.0V, <8V
 - Short Circuit Current ≥ 200.0mA
 - Live Circuit Detection if Greater than or equal to 2V @AC/DC Inputs test inhibited.
The top LCD will display the actual live voltage sensed.

Function	Range	Resolution	Accuracy of Reading
Continuity	400.0Ω	0.1 Ω	± (0.5% + 2 digits)
Diode	2.000V	0.001V	± (1.5% + 2 digits)

- Notes:**
- Continuity:** Built-in buzzer sounds when measured resistance threshold is met (adjustable from 10Ω to 50Ω, default is 30Ω).
- Continuity MAX Test Current:** 1mA
- Continuity MAX Open Circuit Voltage >3.0V**
- Diode MAX Test Current:** 1mA
- Diode MAX Open Circuit Voltage:** 3.0V
- Overload Protection:** 1000V AC rms or DC

Function	Range	Resolution	Accuracy of Reading
Capacitance	1000 μF	1μF	± (1.2% + 2 digits)
	10.00mF	0.01mF	± (1.2% + 20 digits)

- Notes:** 1. Overload Protection: 1000V AC rms or DC

Function	Range	Resolution	Accuracy of Reading
Frequency (ACV)	400.0Hz	0.1Hz	± 5 digits
	4.000kHz	0.001kHz	± 5 digits
	40.00kHz	0.01kHz	± 5 digits

Function	Resistance Range	Resolution	Accuracy of Reading
Insulation Resistance	4.000MΩ	0.001MΩ	± (1.5% + 5 digits)
	40.00 MΩ	0.01MΩ	
	400.0MΩ	0.1MΩ	± (3.0% + 5 digits)
	4000 MΩ	1MΩ	
	4.1GΩ to 20.0GΩ	0.1GΩ	± (10.0% + 3 digits)
	<i>Test voltages</i>	<i>Min. Resistance</i>	<i>Max. Resistance</i>
	50V	50kΩ	50.0MΩ
	100V	100kΩ	100.0MΩ
	250V	250kΩ	250.0MΩ
	500V	500kΩ	500.0MΩ
1000V	1MΩ	20GΩ	

- Notes:**
1. Test Current = 1 mA
 2. Test Voltage Accuracy: +0% to +20%; Short Circuit Test Current: 1mA (nominal)
 3. Auto Discharge Function: Discharge time <1 second for Cap. <1μF
 4. Max. Capacitive Load: Operable with up to 1μF load.
 5. Live Circuit Detection: If >2V AC/DC detected test inhibited.
The top LCD will display the actual live voltage sensed.

7.3 Input Specifications

Function	Maximum Input
AC Voltage, DC Voltage	1000V DC/AC
Insulation Test	No LIVE Voltage IN - Protected

8. Customer Support

For technical assistance, repair and returns, document downloads, and general information, visit the support site, link below:

<https://support.flir.com>

9. Warranty

9.1 FLIR Limited Lifetime Warranty

This product is protected by FLIR's Limited Lifetime Warranty.

Visit <https://support.flir.com/prodreg> to register your product and read the Limited Lifetime Warranty document.



Website

<https://www.flir.com>

Customer Support

<https://support.flir.com>

Disclaimer

Specifications subject to change without further notice. Models and accessories subject to regional market considerations. License procedures may apply. Products described herein may be subject to US Export Regulations. Please refer to exportquestions@flir.com with any questions.

There is no export-controlled information contained in this user manual.

Publication Identification No.:	IM75-2_en-US
Release version:	AA
Release Date:	2023 September
Language:	en-US

Copyright © 2023, Teledyne FLIR Commercial Systems, Inc.
All rights reserved worldwide.